



CAR OPS 1

COMMERCIAL AIR TRANSPORTATION (AEROPLANES)

FOREWORD

CONTENTS – General

CONTENTS - SECTION 1

CONTENTS – SECTION 2

REVISION RECORD

LIST of EFFECTIVE PAGES



This Page Intentionally Left Blank



FOREWORD

1. The Republic of San Marino Civil Aviation Authority, known in these regulations as the “Authority” has implemented CAR OPS 1 (Civil Aviation Regulations – Operations Aeroplane) as the technical requirements and administrative procedures applicable to commercial transportation by aeroplane.
2. CAR OPS 1 is known in these regulations as OPS 1 and includes Standards and Recommended Practices up to and including ICAO Annex 6, Part I, Amendment 48.
3. The Authority has adopted associated compliance wherever possible and, unless specifically stated otherwise, clarification will be based on this material or other internationally acceptable documentation.
4. Unless otherwise stated, applicable CAR DEF definitions and abbreviations are used throughout this document.
5. The editing practices used in this document are as follows:
 - (a) ‘Shall’ or ‘Will’ or ‘Must’ is used to indicate a mandatory requirement.
 - (b) ‘Should’ is used to indicate a recommendation.
 - (c) ‘May’ is used to indicate discretion by the Authority, the industry or the applicant, as appropriate.

Note: The use of the male gender implies the female gender and vice versa.

6. The phrase “acceptable to the Authority” has been used throughout these regulations and acceptability shall be determined by the operator procedures specified in the operations manual.
7. Paragraphs and sub-paragraphs with new, amended and corrected text will be enclosed within square brackets until a subsequent “amendment” is issued.
8. Section 1 regulations are presented in “Times Roman” font and Section 2 guidance material is presented in “Arial” font.



This Page Intentionally Left Blank



REVISION RECORD

REVISION NO.	EFFECTIVE DATE	ENTERED BY <i>(Hardcopy only)</i>
2 nd Edition Initial issue	01 July 2013	
Rev 01	01 August 2014	
Rev 02	01 February 2015	
Rev 03	01 December 2015	
Rev 04	14 October 2016	
Rev 05	01 February 2017	
Rev 06	10 March 2017	
Rev 07	01 January 2018	
Rev 08	01 July 2018	
Rev 09	01 January 2019	
Rev 10	01 July 2019	
Rev 11	01 January 2020	
Rev 12	01 July 2020	
Rev 13	01 January 2021	
Rev 14	01 July 2021	
Rev 15	01 January 2022	
Rev 16	01 April 2022	
Rev 17	01 December 2022	
Rev 18	01 July 2023	
Rev 19	01 October 2023	
Rev 20	01 January 2024	
Rev 21	01 July 2024	



LIST OF EFFECTIVE PAGES

i	01 Jul 24	1-B-23	01 Jan 21	1-D-34	01 Jan 24	1-F-3	01 Feb 17
ii	01 Jul 24	1-B-24	01 Jan 21	1-D-35	01 Dec 22	1-F-4	01 Feb 17
iii	01 Jul 24	1-B-25	01 Jan 21	1-D-36	01 Dec 22	1-G-1	01 Jul 13
iv	01 Jul 24	1-B-26	01 Jan 21	1-D-37	01 Dec 22	1-G-2	01 Jul 13
v	01 Jul 24	1-B-27	01 Jan 21	1-D-38	01 Dec 22	1-G-3	01 Jul 13
vi	01 Jul 24	1-B-28	01 Jan 21	1-D-39	01 Dec 22	1-G-4	01 Jul 13
vii	01 Dec 22	1-B-29	01 Jan 21	1-D-40	01 Dec 22	1-G-5	01 Jul 13
viii	01 Dec 22	1-B-30	01 Jan 21	1-D-41	01 Dec 22	1-G-6	01 Jul 13
ix	01 Jan 24	1-B-31	01 Jan 21	1-D-42	01 Dec 22	1-G-7	01 Jul 13
x	01 Jan 24	1-B-32	01 Jan 21	1-D-43	01 Jul 20	1-G-8	01 Jul 13
xi	01 Jan 24	1-C-1	01 Dec 22	1-D-44	01 Jul 20	1-G-9	01 Jul 13
xii	01 Jan 24	1-C-2	01 Dec 22	1-E-1	01 Jan 24	1-G-10	01 Jul 13
xiii	01 Jan 24	1-C-3	01 Dec 22	1-E-2	01 Jan 24	1-H-1	01 Jul 13
xiv	01 Jan 24	1-C-4	01 Dec 22	1-E-3	01 Jan 24	1-H-2	01 Jul 13
xv	01 Jan 24	1-C-5	01 Dec 22	1-E-4	01 Jan 24	1-H-3	01 Jul 13
xvi	01 Jan 24	1-C-6	01 Dec 22	1-E-5	01 Jan 24	1-H-4	01 Jul 13
xvii	01 Jan 24	1-C-7	01 Dec 22	1-E-6	01 Jan 24	1-H-5	01 Jul 13
xviii	01 Jan 24	1-C-8	01 Dec 22	1-E-7	01 Jan 24	1-H-6	01 Jul 13
xix	01 Jan 24	1-D-1	01 Jan 24	1-E-8	01 Jan 24	1-H-7	01 Jul 13
xx	01 Jan 24	1-D-2	01 Jan 24	1-E-9	01 Jan 24	1-H-8	01 Jul 13
xxi	01 Jan 24	1-D-3	01 Jan 24	1-E-10	01 Jan 24	1-H-9	01 Jul 13
xxii	01 Jan 24	1-D-4	01 Jan 24	1-E-11	01 Jan 24	1-H-10	01 Jul 13
xxiii	01 Jan 24	1-D-5	01 Jan 24	1-E-12	01 Jan 24	1-H-11	01 Jul 13
xxiv	01 Jan 24	1-D-6	01 Jan 24	1-E-13	01 Jan 24	1-H-12	01 Jul 13
		1-D-7	01 Jan 24	1-E-14	01 Jan 24	1-I-1	01 Jul 13
		1-D-8	01 Jan 24	1-E-15	01 Jan 24	1-I-2	01 Jul 13
		1-D-9	01 Jan 24	1-E-16	01 Jan 24	1-I-3	01 Jul 13
		1-D-10	01 Jan 24	1-E-17	01 Jan 24	1-I-4	01 Jul 13
		1-D-11	01 Jan 24	1-E-18	01 Jan 24	1-I-5	01 Jul 13
		1-D-12	01 Jan 24	1-E-19	01 Jan 24	1-I-6	01 Jul 13
		1-D-13	01 Jan 24	1-E-20	01 Jan 24	1-J-1	01 Jul 13
		1-D-14	01 Jan 24	1-E-21	01 Jan 24	1-J-2	01 Jul 13
		1-D-15	01 Jan 24	1-E-22	01 Jan 24	1-J-3	01 Jul 13
		1-D-16	01 Jan 24	1-E-23	01 Jan 24	1-J-4	01 Jul 13
		1-D-17	01 Jan 24	1-E-24	01 Jan 24	1-J-5	01 Jul 13
		1-D-18	01 Jan 24	1-E-25	01 Jan 24	1-J-6	01 Jul 13
		1-D-19	01 Jan 24	1-E-26	01 Jan 24	1-J-7	01 Jul 13
		1-D-20	01 Jan 24	1-E-27	01 Jan 24	1-J-8	01 Jul 13
		1-D-21	01 Jan 24	1-E-28	01 Jan 24	1-J-9	01 Jul 13
		1-D-22	01 Jan 24	1-E-29	01 Jan 24	1-J-10	01 Jul 13
		1-D-23	01 Jan 24	1-E-30	01 Jan 24	1-J-11	01 Jul 13
		1-D-24	01 Jan 24	1-E-31	01 Jan 24	1-J-12	01 Jul 13
		1-D-25	01 Jan 24	1-E-32	01 Jan 24	1-J-13	01 Jul 13
		1-D-26	01 Jan 24	1-E-33	01 Jan 24	1-J-14	01 Jul 13
		1-D-27	01 Jan 24	1-E-34	01 Jan 24	1-K-1	01 Jul 24
		1-D-28	01 Jan 24	1-E-35	01 Jan 24	1-K-2	01 Jul 24
		1-D-29	01 Jan 24	1-E-36	01 Jan 24	1-K-3	01 Jul 24
		1-D-30	01 Jan 24	1-E-37	01 Jan 24	1-K-4	01 Jul 24
		1-D-31	01 Jan 24	1-E-38	01 Jan 24	1-K-5	01 Jul 24
		1-D-32	01 Jan 24	1-F-1	01 Feb 17	1-K-6	01 Jul 24
		1-D-33	01 Jan 24	1-F-2	01 Feb 17	1-K-7	01 Jul 24

Section 1

1-A-1	01 Jul 13
1-A-2	01 Jul 13
1-B-1	01 Jan 21
1-B-2	01 Jan 21
1-B-3	01 Jan 21
1-B-4	01 Jan 21
1-B-5	01 Jan 21
1-B-6	01 Jan 21
1-B-7	01 Jan 21
1-B-8	01 Jan 21
1-B-9	01 Jan 21
1-B-10	01 Jan 21
1-B-11	01 Jan 21
1-B-12	01 Jan 21
1-B-13	01 Jan 21
1-B-14	01 Jan 21
1-B-15	01 Jan 21
1-B-16	01 Jan 21
1-B-17	01 Jan 21
1-B-18	01 Jan 21
1-B-19	01 Jan 21
1-B-20	01 Jan 21
1-B-21	01 Jan 21
1-B-22	01 Jan 21



1-K-8 01 Jul 24	1-M-3 01 Oct 23	1-O-18 01 Feb 15	i 01 Jan 18
1-K-9 01 Jul 24	1-M-4 01 Oct 23	1-O-19 01 Feb 15	ii 01 Jan 18
1-K-10 01 Jul 24	1-M-5 01 Oct 23	1-O-20 01 Feb 15	2-B-1 01 Jan 19
1-K-11 01 Jul 24	1-M-6 01 Oct 23	1-P-1 01 Dec 22	2-B-2 01 Jan 19
1-K-12 01 Jul 24	1-M-7 01 Oct 23	1-P-2 01 Dec 22	2-B-3 01 Jan 19
1-K-13 01 Jul 24	1-M-8 01 Oct 23	1-P-3 01 Dec 22	2-B-4 01 Jan 19
1-K-14 01 Jul 24	1-M-9 01 Oct 23	1-P-4 01 Dec 22	2-B-5 01 Jul 19
1-K-15 01 Jul 24	1-M-10 01 Oct 23	1-P-5 01 Dec 22	2-B-6 01 Jul 19
1-K-16 01 Jul 24	1-M-11 01 Oct 23	1-P-6 01 Dec 22	2-B-7 01 Jul 19
1-K-17 01 Jul 24	1-M-12 01 Oct 23	1-P-7 01 Dec 22	2-B-8 01 Jul 19
1-K-18 01 Jul 24	1-N-1 01 Jul 21	1-P-8 01 Dec 22	2-B-9 01 Jul 19
1-K-19 01 Jul 24	1-N-2 01 Jul 21	1-P-9 01 Dec 22	2-B-10 01 Jul 19
1-K-20 01 Jul 24	1-N-3 01 Jul 21	1-P-10 01 Dec 22	2-B-11 01 Jul 19
1-K-21 01 Jul 24	1-N-4 01 Jul 21	1-P-11 01 Dec 22	2-B-12 01 Jul 19
1-K-22 01 Jul 24	1-N-5 01 Jul 21	1-P-12 01 Dec 22	2-B-13 01 Jul 19
1-K-23 01 Jul 24	1-N-6 01 Jul 21	1-P-13 01 Dec 22	2-B-14 01 Jul 19
1-K-24 01 Jul 24	1-N-7 01 Jul 21	1-P-14 01 Dec 22	2-B-15 01 Jul 19
1-K-25 01 Jul 24	1-N-8 01 Jul 21	1-P-15 01 Dec 22	2-B-16 01 Jul 19
1-K-26 01 Jul 24	1-N-9 01 Jul 21	1-P-16 01 Dec 22	2-B-17 01 Jul 19
1-K-27 01 Jul 24	1-N-10 01 Jul 21	1-P-17 01 Dec 22	2-B-18 01 Jul 19
1-K-28 01 Dec 22	1-N-11 01 Jul 21	1-P-18 01 Dec 22	2-B-19 01 Jul 19
1-K-29 01 Dec 22	1-N-12 01 Jul 21	1-P-19 01 Dec 22	2-B-20 01 Jul 19
1-K-30 01 Dec 22	1-N-13 01 Jul 21	1-P-20 01 Dec 22	2-B-21 01 Jul 19
1-K-31 01 Dec 22	1-N-14 01 Jul 21	1-P-21 01 Dec 22	2-B-22 01 Jul 19
1-K-32 01 Dec 22	1-N-15 01 Jul 21	1-P-22 01 Dec 22	2-B-23 01 Jul 19
1-K-33 01 Dec 22	1-N-16 01 Jul 21	1-P-23 01 Dec 22	2-B-24 01 Jul 19
1-K-34 01 Dec 22	1-N-17 01 Jul 21	1-P-24 01 Dec 22	2-B-25 01 Jul 19
1-K-35 01 Dec 22	1-N-18 01 Jul 21	1-Q-1 01 Jan 24	2-B-26 01 Jul 19
1-K-36 01 Dec 22	1-N-19 01 Jul 21	1-Q-2 01 Jan 24	2-C-1 01 Jul 19
1-K-37 01 Dec 22	1-N-20 01 Jul 21	1-Q-3 01 Jan 24	2-C-2 01 Jul 19
1-K-38 01 Dec 22	1-N-21 01 Jul 21	1-Q-4 01 Jan 24	2-C-3 01 Jul 19
1-K-39 01 Dec 22	1-N-22 01 Jul 21	1-Q-5 01 Jan 24	2-C-4 01 Jul 19
1-K-40 01 Dec 22	1-N-23 01 Jul 21	1-Q-6 01 Jan 24	2-D-1 01 Dec 22
1-K-41 01 Dec 22	1-N-24 01 Jul 21	1-Q-7 01 Jan 24	2-D-2 01 Dec 22
1-K-42 01 Dec 22	1-N-25 01 Jul 21	1-Q-8 01 Jan 24	2-D-3 01 Dec 22
1-K-43 01 Dec 22	1-N-26 01 Jul 21	1-Q-9 01 Jan 24	2-D-4 01 Dec 22
1-K-44 01 Dec 22	1-O-1 01 Feb 15	1-Q-10 01 Jan 24	2-D-5 01 Dec 22
1-K-45 01 Dec 22	1-O-2 01 Feb 15	1-Q-11 01 Jan 24	2-D-6 01 Dec 22
1-K-46 01 Dec 22	1-O-3 01 Feb 15	1-Q-12 01 Jan 24	2-D-7 01 Dec 22
1-K-47 01 Dec 22	1-O-4 01 Feb 15	1-R-1 01 Jan 21	2-D-8 01 Dec 22
1-K-48 01 Dec 22	1-O-5 01 Feb 15	1-R-2 01 Jan 21	2-D-9 01 Dec 22
1-K-49 01 Dec 22	1-O-6 01 Feb 15	1-R-3 01 Jan 21	2-D-10 01 Dec 22
1-K-50 01 Dec 22	1-O-7 01 Feb 15	1-R-4 01 Jan 21	2-D-11 01 Dec 22
1-K-51 01 Dec 22	1-O-8 01 Feb 15	1-R-5 01 Jan 21	2-D-12 01 Dec 22
1-K-52 01 Dec 22	1-O-9 01 Feb 15	1-R-6 01 Jan 21	2-D-13 01 Dec 22
1-L-1 01 Jul 21	1-O-10 01 Feb 15	1-R-7 01 Jan 21	2-D-14 01 Dec 22
1-L-2 01 Jul 21	1-O-11 01 Feb 15	1-R-8 01 Jan 21	2-D-15 01 Dec 22
1-L-3 01 Jul 21	1-O-12 01 Feb 15	1-R-9 01 Jan 21	2-D-16 01 Dec 22
1-L-4 01 Jan 21	1-O-13 01 Feb 15	1-R-10 01 Jan 21	2-D-17 01 Dec 22
1-L-5 01 Jul 21	1-O-14 01 Feb 15	1-S-1 01 Jan 24	2-D-18 01 Dec 22
1-L-6 01 Jul 21	1-O-15 01 Feb 15	1-S-2 01 Jan 24	2-D-19 01 Dec 22
1-M-1 01 Oct 23	1-O-16 01 Feb 15		2-D-20 01 Dec 22
1-M-2 01 Oct 23	1-O-17 01 Feb 15		2-D-21 01 Jul 20

Section 2



2-D-22 01 Jul 20	2-F-2 01 Jan 18	2-K-12 01 Jan 19	2-N-12 01 Jan 22
2-D-23 01 Jul 20	2-G-1 01 Jan 18	2-L-1 01 Jan 18	2-N-13 01 Jan 22
2-D-24 01 Jul 20	2-G-2 01 Jan 18	2-L-2 01 Jan 18	2-N-14 01 Jan 22
2-D-25 01 Jul 20	2-G-3 01 Jan 18	2-L-3 01 Jan 18	2-N-15 01 Jan 22
2-D-26 01 Jul 20	2-G-4 01 Jan 18	2-L-4 01 Jan 18	2-N-16 01 Jan 22
2-D-27 01 Jul 20	2-G-5 01 Jan 18	2-M-1 01 Dec 22	2-N-17 01 Jan 22
2-D-28 01 Jul 20	2-G-6 01 Jan 18	2-M-2 01 Dec 22	2-N-18 01 Jan 22
2-D-29 01 Jul 20	2-H-1 01 Jul 21	2-M-3 01 Dec 22	2-N-19 01 Jan 22
2-D-30 01 Jul 20	2-H-2 01 Jul 21	2-M-4 01 Dec 22	2-N-20 01 Jan 22
2-D-31 01 Jul 20	2-H-3 01 Jul 21	2-M-5 01 Dec 22	2-O-1 01 Jan 22
2-D-32 01 Jul 20	2-H-4 01 Jul 21	2-M-6 01 Dec 22	2-O-2 01 Jan 22
2-D-33 01 Jul 20	2-H-5 01 Jul 21	2-M-7 01 Dec 22	2-O-3 01 Jan 22
2-D-34 01 Jul 20	2-H-6 01 Jul 21	2-M-8 01 Dec 22	2-O-4 01 Jan 22
2-D-35 01 Jul 20	2-H-7 01 Jul 21	2-M-9 01 Dec 22	2-O-5 01 Jan 22
2-D-36 01 Jul 20	2-H-8 01 Jul 21	2-M-10 01 Dec 22	2-O-6 01 Jan 22
2-E-1 01 Dec 22	2-H-9 01 Jul 21	2-M-11 01 Dec 22	2-O-7 01 Jan 22
2-E-2 01 Dec 22	2-H-10 01 Jul 21	2-M-12 01 Dec 22	2-O-8 01 Jan 22
2-E-3 01 Dec 22	2-I-1 01 Jan 18	2-M-13 01 Dec 22	2-O-9 01 Jan 22
2-E-4 01 Dec 22	2-I-2 01 Jan 18	2-M-14 01 Dec 22	2-O-10 01 Jan 22
2-E-5 01 Dec 22	2-I-3 01 Jan 18	2-M-15 01 Dec 22	2-P-1 01 Jul 18
2-E-6 01 Dec 22	2-I-4 01 Jan 18	2-M-16 01 Dec 22	2-P-2 01 Jul 18
2-E-7 01 Dec 22	2-I-5 01 Jan 18	2-M-17 01 Dec 22	2-P-3 01 Jul 18
2-E-8 01 Dec 22	2-I-6 01 Jan 18	2-M-18 01 Dec 22	2-P-4 01 Jul 18
2-E-9 01 Dec 22	2-J-1 01 Jan 19	2-M-19 01 Dec 22	2-Q-1 01 Dec 22
2-E-10 01 Dec 22	2-J-2 01 Jan 19	2-M-20 01 Dec 22	2-Q-2 01 Dec 22
2-E-11 01 Dec 22	2-J-3 01 Jan 19	2-M-21 01 Dec 22	2-Q-3 01 Dec 22
2-E-12 01 Dec 22	2-J-4 01 Jan 19	2-M-22 01 Dec 22	2-Q-4 01 Dec 22
2-E-13 01 Jan 18	2-J-5 01 Jan 19	2-M-23 01 Dec 22	2-R-1 01 Jan 18
2-E-14 01 Jan 18	2-J-6 01 Jan 19	2-M-24 01 Dec 22	2-R-2 01 Jan 18
2-E-15 01 Jan 18	2-K-1 01 Jan 19	2-N-1 01 Jan 22	2-R-3 01 Jan 18
2-E-16 01 Jan 18	2-K-2 01 Jan 19	2-N-2 01 Jan 22	2-R-4 01 Jan 18
2-E-17 01 Jan 18	2-K-3 01 Jan 19	2-N-3 01 Jan 22	2-R-5 01 Jan 18
2-E-18 01 Jan 18	2-K-4 01 Jan 19	2-N-4 01 Jan 22	2-R-6 01 Jan 18
2-E-19 01 Jan 18	2-K-5 01 Jan 19	2-N-5 01 Jan 22	2-R-7 01 Jan 18
2-E-20 01 Jan 18	2-K-6 01 Jan 19	2-N-6 01 Jan 22	2-R-8 01 Jan 18
2-E-21 01 Jan 18	2-K-7 01 Jan 19	2-N-7 01 Jan 22	2-S-1 01 Jul 21
2-E-22 01 Jan 18	2-K-8 01 Jan 19	2-N-8 01 Jan 22	2-S-2 01 Jul 21
2-E-23 01 Jan 18	2-K-9 01 Jan 19	2-N-9 01 Jan 22	---End---
2-E-24 01 Jan 18	2-K-10 01 Jan 19	2-N-10 01 Jan 22	
2-F-1 01 Jan 18	2-K-11 01 Jan 19	2-N-11 01 Jan 22	



CONTENTS-General

CAR OPS 1

COMMERCIAL AIR TRANSPORTATION (AEROPLANES)

SECTION 1 - REGULATIONS

SUBPART A-	APPLICABILITY
SUBPART B-	GENERAL
SUBPART C-	OPERATOR CERTIFICATION AND SUPERVISION
SUBPART D-	OPERATIONAL PROCEDURES
SUBPART E-	ALL WEATHER OPERATIONS
SUBPART F-	PERFORMANCE GENERAL
SUBPART G-	PERFORMANCE CLASS A
SUBPART H-	PERFORMANCE CLASS B
SUBPART I -	PERFORMANCE CLASS C
SUBPART J -	MASS AND BALANCE
SUBPART K-	INSTRUMENTS AND EQUIPMENT
SUBPART L-	COMMUNICATION, NAVIGATION & SURVEILLANCE EQUIPMENT
SUBPART M-	AEROPLANE MAINTENANCE
SUBPART N-	FLIGHT CREW
SUBPART O-	CABIN CREW
SUBPART P-	MANUALS, LOGS AND RECORDS
SUBPART Q-	FLIGHT/DUTY TIME AND REST REQUIREMENTS
SUBPART R-	TRANSPORT OF DANGEROUS GOODS BY AIR
SUBPART S-	SECURITY



**SECTION 2 ADVISORY CIRCULARS (AC) / ACCEPTABLE MEANS OF
COMPLIANCE (AMC)**

AC/AMC B - GENERAL

AC/AMC C - OPERATOR CERTIFICATION & SUPERVISION

AC/AMC D - OPERATIONAL PROCEDURES

AC/AMC E - ALL WEATHER OPERATIONS

AC/AMC G - PERFORMANCE CLASS A

AC/AMC H - PERFORMANCE CLASS B

AC/AMC I - PERFORMANCE CLASS C

AC/AMC J - MASS & BALANCE

AC/AMC K - INSTRUMENTS AND EQUIPMENT

AC/AMC L - COMMUNICATION, NAVIGATION & SURVEILLANCE EQUIPMENT

AC/AMC M - AEROPLANE MAINTENANCE

AC/AMC N - FLIGHT CREW

AC/AMC O - CABIN CREW

AC/AMC P - MANUALS, LOGS & RECORDS

AC/AMC Q - FLIGHT/DUTY TIME AND REST REQUIREMENTS

AC/AMC R - TRANSPORT OF DANGEROUS GOODS BY AIR

AC S - SECURITY



CONTENTS (details)

CAR OPS 1

COMMERCIAL AIR TRANSPORTATION (AEROPLANES)

SECTION 1 - REGULATIONS

SUBPART A — APPLICABILITY

OPS 1.001	Applicability.....	1-A-1
OPS 1.002	Air Operating Licence.....	1-A-1

SUBPART B — GENERAL

OPS 1.005	General.....	1-B-1
OPS 1.010	Exemptions.....	1-B-1
OPS 1.015	Operational Directives.....	1-B-1
OPS 1.020	Laws, Regulations and Procedures- Operator's Responsibilities.....	1-B-1
OPS 1.023	Compliance by Foreign Operator with Laws, Regulations & Procedures..	1-B-2
OPS 1.025	Common Language.....	1-B-2
OPS 1.030	Minimum Equipment Lists – Operator's Responsibilities.....	1-B-2
OPS 1.035	Quality System.....	1-B-3
OPS 1.037	Safety Management System.....	1-B-3
OPS 1.040	Crew Members.....	1-B-4
OPS 1.050	Search and Rescue Information.....	1-B-4
OPS 1.055	Information on Emergency and Survival Equipment Carried.....	1-B-4
OPS 1.060	Ditching.....	1-B-4
OPS 1.065	Carriage of Weapons of War and Munitions of War.....	1-B-4
OPS 1.070	Carriage of Sporting Weapons and Ammunition.....	1-B-5
OPS 1.075	Method of Carriage of Persons.....	1-B-5
OPS 1.085	Crew Responsibilities.....	1-B-5
OPS 1.090	Authority of the Commander.....	1-B-8
OPS 1.095	Authority to Taxi an Aeroplane.....	1-B-8
OPS 1.100	Admission to Flight Deck.....	1-B-8
OPS 1.105	Unauthorised Carriage.....	1-B-9
OPS 1.110	Portable Electronic Devices.....	1-B-9
OPS 1.115	Alcohol and Drugs.....	1-B-9
OPS 1.120	Endangering Safety.....	1-B-9
OPS 1.125	Documents to be Carried.....	1-B-9
OPS 1.130	Manuals to be Carried.....	1-B-10
OPS 1.135	Additional Information and Forms to be Carried.....	1-B-10
OPS 1.140	Information Retained on the Ground.....	1-B-11
OPS 1.145	Power to Inspect.....	1-B-11
OPS 1.150	Production of Documentation and Records.....	1-B-11
OPS 1.155	Preservation of Documentation.....	1-B-11
OPS 1.160	Preservation, Production & Use of Flight Recorder Recordings.....	1-B-12
OPS 1.161	Use of Flight Recorder Recordings by the Authority.....	1-B-13
OPS 1.165	Leasing.....	1-B-14
OPS 1.170	Aeroplanes Operated under an Article 83 <i>bis</i> Agreement.....	1-B-15
Appendix 1 to OPS 1.005(a)	Operations of Performance Class B Aeroplanes.....	1-B-16
Appendix 1 to OPS 1.037	Framework for a Safety Management System (SMS).....	1-B-25



Appendix 1 to
OPS 1.125 Documents to be Carried..... 1-B-29

Appendix 1 to
OPS 1.161 Principles for protection of safety data/information and related sources.. 1-B-30

SUBPART C — OPERATOR CERTIFICATION AND SUPERVISION

OPS 1.175 General Rules for Air Operator Certification..... 1-C-1

OPS 1.180 Issue, Variation and Continued Validity of an AOC 1-C-2

OPS 1.185 Administrative Requirements..... 1-C-3

OPS 1.190 Use of Other State’s Registered Aircraft 1-C-4

Appendix 1 to
OPS 1.175 Contents and Conditions of the Air Operator Certificate..... 1-C-5

Appendix 2 to
OPS 1.175 The Management and Organisation of an AOC holder..... 1-C-7

SUBPART D — OPERATIONAL PROCEDURES

OPS 1.192 Terminology 1-D-1

OPS 1.195 Operational Control..... 1-D-1

OPS 1.197 Aircraft Tracking..... 1-D-2

OPS 1.200 Operations Manual 1-D-3

OPS 1.205 Competence of Operations Personnel 1-D-3

OPS 1.207 Flight Dispatcher 1-D-3

OPS 1.210 Establishment of Procedures 1-D-4

OPS 1.215 Use of Air Traffic Services 1-D-5

OPS 1.216 In flight Operational Instructions 1-D-5

OPS 1.220 Authorisation of Aerodromes by the Operator..... 1-D-5

OPS 1.225 Aerodrome Operating Minima..... 1-D-5

OPS 1.230 Instrument Departure and Approach Procedures 1-D-6

OPS 1.235 Noise Abatement Procedures 1-D-6

OPS 1.240 Routes and Areas of Operation 1-D-7

OPS 1.241 Operation in Defined Airspace with Reduced Vertical
Separation Minima (RVSM) 1-D-8

OPS 1.243 Operations in Areas with Specified Navigation Performance
Requirements..... 1-D-9

OPS 1.245 Maximum Distance from an Adequate Aerodrome for
Two-engine Aeroplanes Without an EDTO Approval..... 1-D-9

OPS 1.246 Extended Diversion Time Operations (EDTO)..... 1-D-11

OPS 1.250 Establishment of Minimum Flight Altitudes..... 1-D-13

OPS 1.255 Fuel Policy 1-D-14

OPS 1.260 Carriage of Persons with Reduced Mobility 1-D-15

OPS 1.265 Carriage of Inadmissible Passengers, Deportees or Persons
in Custody 1-D-16

OPS 1.270 Stowage of Baggage and Cargo 1-D-16

OPS 1.275 Cargo Compartment Safety 1-D-16

OPS 1.280 Passenger Seating..... 1-D-17

OPS 1.285 Passenger Briefing 1-D-17

OPS 1.290 Flight Preparation..... 1-D-18

OPS 1.295 Selection of Aerodromes..... 1-D-19

OPS 1.297 Planning Minima for IFR Flights 1-D-21

OPS 1.300 Submission of ATS Flight Plan..... 1-D-22

OPS 1.305 Refuelling/Defueling with Passengers Embarking, on Board
or Disembarking..... 1-D-22



OPS 1.307	Refuelling/Defueling with Wide-cut Fuel.....	1-D-22
OPS 1.308	Pushback and Towing	1-D-22
OPS 1.310	Crew Members at Stations	1-D-23
OPS 1.311	Minimum Number of Cabin Crew Required to be on Board an Aeroplane During Ground Operations with Passengers	1-D-23
OPS 1.313	Use of Headset	1-D-24
OPS 1.315	Assisting Means for Emergency Evacuation	1-D-24
OPS 1.320	Seats, Safety Belts and Harnesses	1-D-24
OPS 1.325	Securing of Passenger Cabin and Galley(s).....	1-D-25
OPS 1.330	Accessibility of Emergency Equipment.....	1-D-25
OPS 1.335	Smoking on Board.....	1-D-25
OPS 1.340	Meteorological Conditions.....	1-D-25
OPS 1.345	Ice and other Contaminants - Ground Procedures	1-D-26
OPS 1.346	Ice and other Contaminants – Flight Procedures	1-D-27
OPS 1.350	Fuel and Oil Supply	1-D-27
OPS 1.355	Take-off Conditions	1-D-27
OPS 1.360	Application of Take-off Minima.....	1-D-27
OPS 1.365	Minimum Flight Altitudes.....	1-D-27
OPS 1.370	Simulated Abnormal Situations in Flight.....	1-D-27
OPS 1.375	In-flight Fuel Management	1-D-27
OPS 1.385	Use of Supplemental Oxygen	1-D-29
OPS 1.390	Cosmic Radiation	1-D-29
OPS 1.395	Ground Proximity Detection.....	1-D-30
OPS 1.398	Use of Airborne Collision Avoidance System (ACAS).....	1-D-30
OPS 1.400	Approach and Landing Conditions	1-D-31
OPS 1.405	Commencement and Continuation of Approach.....	1-D-31
OPS 1.410	Operating procedures – Threshold Crossing Height.....	1-D-32
OPS 1.415	Journey Log	1-D-32
OPS 1.420	Occurrence Reporting	1-D-32
Appendix 1 to OPS 1.241(b)(1)	Height-keeping Performance Requirements	1-D-35
Appendix 1 to OPS 1.255	Fuel Policy	1-D-36
Appendix 2 to OPS 1.255	Fuel Policy on Location of the 3% En-Route Alternate (3% ERA) Aerodrome for the Purpose of Reducing Contingency Fuel to 3%	1-D-41
Appendix 1 to OPS 1.270	Stowage of Baggage and Cargo	1-D-42
Appendix 1 to OPS 1.305	Refuelling/Defueling with Passengers Embarking, on Board or Disembarking.....	1-D-43
Appendix 1 to OPS 1.311	Minimum Number of Cabin Crew Required to be on Board an Aeroplane during Ground Operations with Passengers	1-D-44

SUBPART E — ALL WEATHER OPERATIONS

OPS 1.430	Aerodrome Operating Minima – General	1-E-1
OPS 1.435	Terminology	1-E-3
OPS 1.440	Low Visibility Operations – General Operating Rules	1-E-4
OPS 1.445	Low Visibility Operations – Aerodrome Considerations.....	1-E-5
OPS 1.450	Low Visibility Operations – Training and Qualifications.....	1-E-5
OPS 1.455	Low Visibility Operations – Operating Procedures	1-E-5
OPS 1.460	Low Visibility Operations – Minimum Equipment	1-E-6



OPS 1.465	VFR Operating Minima	1-E-6
Appendix 1 to OPS 1.430	Aerodrome Operating Minima	1-E-7
Appendix 2 to OPS 1.430 (b)	Aeroplane Categories – All Weather Operations	1-E-24
Appendix 1 to OPS 1.440	Low Visibility Operations – General Operating Rules	1-E-25
Appendix 1 to OPS 1.450	Low Visibility Operations – Training & Qualifications	1-E-28
Appendix 1 to OPS 1.455	Low Visibility Operations – Operating Procedures	1-E-37

SUBPART F — PERFORMANCE GENERAL

OPS 1.470	Applicability	1-F-1
OPS 1.475	General	1-F-1
OPS 1.480	Terminology	1-F-2

SUBPART G — PERFORMANCE CLASS A

OPS 1.485	General	1-G-1
OPS 1.490	Take-off	1-G-1
OPS 1.495	Take-off Obstacle Clearance	1-G-2
OPS 1.500	En-route – One-engine-inoperative	1-G-3
OPS 1.505	En-route – Aeroplanes with Three or More Engines, Two Engines Inoperative	1-G-4
OPS 1.510	Landing – Destination and Alternate Aerodromes	1-G-4
OPS 1.515	Landing – Dry Runways	1-G-5
OPS 1.520	Landing – Wet and Contaminated Runways	1-G-6
Appendix 1 to OPS 1.495(c)(3)	Approval of Increased Bank Angles	1-G-7
Appendix 1 to OPS 1.515(a)(3)	Steep Approach Procedures	1-G-8
Appendix 1 to OPS 1.515(a)(4)	Short Landing Operations	1-G-9
Appendix 2 to OPS 1.515(a)(4)	Airfield Criteria for Short Landing Operations	1-G-10

SUBPART H — PERFORMANCE CLASS B

OPS 1.525	General	1-H-1
OPS 1.526	Operations of Single-engine Turbine Powered Aeroplanes at Night and/or in IMC	1-H-1
OPS 1.530	Take-off	1-H-2
OPS 1.535	Take-off Obstacle Clearance – Multi-Engine Aeroplanes	1-H-3
OPS 1.540	En-Route – Multi-engine Aeroplanes	1-H-4
OPS 1.542	En-Route – Single-engine Aeroplanes	1-H-4
OPS 1.545	Landing – Destination and Alternate Aerodromes	1-H-5
OPS 1.550	Landing – Dry Runway	1-H-5
OPS 1.555	Landing – Wet and Contaminated Runways	1-H-6
Appendix 1 to OPS 1.525(b)	General – Take-off and Landing Climb	1-H-7
Appendix 1 to OPS 1.535(b)(1) & (c)(1)	Take-off Path – Visual Course Guidance Navigation	1-H-9



Appendix 1 to OPS 1.550(a)	Steep Approach Procedures	1-H-10
Appendix 2 to OPS 1.550(a)	Short Landing Operations	1-H-11

SUBPART I — PERFORMANCE CLASS C

OPS 1.560	General	1-I-1
OPS 1.565	Take-off.....	1-I-1
OPS 1.570	Take-off Obstacle Clearance.....	1-I-2
OPS 1.575	En-Route – All Engines Operating	1-I-3
OPS 1.580	En-Route – One-engine-inoperative	1-I-3
OPS 1.585	En-Route – Aeroplanes With Three or More Engines, Two Engines Inoperative.....	1-I-4
OPS 1.590	Landing – Destination and Alternate Aerodromes.....	1-I-4
OPS 1.595	Landing – Dry Runways	1-I-4
OPS 1.600	Landing – Wet and Contaminated Runways.....	1-I-5

SUBPART J — MASS AND BALANCE

OPS 1.605	General	1-J-1
OPS 1.607	Terminology	1-J-1
OPS 1.610	Loading, Mass and Balance	1-J-2
OPS 1.615	Mass Values for Crew	1-J-2
OPS 1.620	Mass Values for Passengers and Baggage	1-J-2
OPS 1.625	Mass and Balance Documentation	1-J-4
Appendix 1 to OPS 1.605	Mass and Balance – General	1-J-5
Appendix 1 to OPS 1.620(f)	Definition of the Area for Flights within the Region.....	1-J-9
Appendix 1 to OPS 1.620(g)	Procedure for Establishing Revised Standard Mass Values for Passengers and Baggage.....	1-J-10
Appendix 1 to OPS 1.625	Mass and Balance Documentation	1-J-12

SUBPART K — INSTRUMENTS AND EQUIPMENT

OPS 1.630	General Introduction	1-K-1
OPS 1.635	Circuit Protection Devices	1-K-2
OPS 1.640	Aeroplane Operating Lights.....	1-K-2
OPS 1.645	Windshield Wipers.....	1-K-2
OPS 1.650	Day VFR operations – Flight and Navigational Instruments and Associated Equipment.....	1-K-3
OPS 1.652	IFR or Night Operations – Flight and Navigational Instruments and Associated Equipment.....	1-K-4
OPS 1.655	Additional Equipment for Single-pilot Operation under IFR or at Night..	1-K-6
OPS 1.660	Altitude Alerting System.....	1-K-7
OPS 1.665	Ground Proximity Warning System.....	1-K-7
OPS 1.668	Airborne Collision Avoidance System.....	1-K-8
OPS 1.670	Airborne Weather Radar Equipment.....	1-K-8
OPS 1.672	Runway Overrun Awareness and Alerting System (ROAAS)	1-K-8
OPS 1.675	Equipment for Operations in Icing Conditions	1-K-8
OPS 1.680	Cosmic Radiation Detection Equipment.....	1-K-9
OPS 1.685	Flight Crew Interphone System	1-K-9



OPS 1.690	Crew Member Interphone System	1-K-9
OPS 1.695	Public Address System.....	1-K-10
OPS 1.700	Cockpit Voice Recorders	1-K-10
OPS 1.710	Flight Data Recorders – Aeroplanes of 5700 kg or Less	1-K-11
OPS 1.715	Flight Data Recorders – Aeroplanes Greater than 5700 kg	1-K-12
OPS 1.720	Flight Data Recorders – Data Link	1-K-13
OPS 1.725	Combination Recorders	1-K-13
OPS 1.730	Seats, Seat Safety Belts, Harnesses & Child Restraint Devices	1-K-13
OPS 1.731	Fasten Seat Belt and No Smoking Signs.....	1-K-14
OPS 1.735	Internal Doors and Curtains	1-K-14
OPS 1.745	First-Aid Kits	1-K-15
OPS 1.755	Emergency Medical Kit	1-K-15
OPS 1.760	First-aid Oxygen.....	1-K-15
OPS 1.770	Supplemental Oxygen – Pressurised Aeroplanes.....	1-K-16
OPS 1.772	Safeguarding of Cabin Crew and Passengers in Pressurised Aeroplanes in the Event of Loss of Pressurisation.....	1-K-18
OPS 1.775	Supplemental oxygen – Non-pressurised Aeroplanes.....	1-K-18
OPS 1.780	Crew Protective Breathing Equipment.....	1-K-18
OPS 1.790	Hand Fire Extinguishers.....	1-K-19
OPS 1.795	Crash Axes and Crowbars	1-K-20
OPS 1.800	Marking of Break-in Points.....	1-K-20
OPS 1.805	Means for Emergency Evacuation	1-K-20
OPS 1.810	Megaphones	1-K-21
OPS 1.815	Emergency Lighting.....	1-K-21
OPS 1.817	Electronic Flight Bag (EFB) Equipment.....	1-K-22
OPS 1.820	Emergency Locator Transmitter	1-K-23
OPS 1.821	Location of an Aircraft in Distress.....	1-K-23
OPS 1.825	Life Jackets.....	1-K-24
OPS 1.830	Life-rafts and Survival ELTs for Extended Overwater Flights.....	1-K-24
OPS 1.835	Survival Equipment.....	1-K-25
OPS 1.840	Seaplanes and Amphibians – Miscellaneous Equipment.....	1-K-25
OPS 1.842	Additional Requirements for Operations of Single-engine Turbine-powered Aeroplanes at Night and/or in IMC.....	1-K-26
Appendix 1 to OPS 1.700	CVR and Cockpit Audio Recording System (CARS).....	1-K-28
Appendix 1 to OPS 1.700/710/715	Flight Recorders – General	1-K-30
Appendix 2 to OPS 1.700/710/715	Inspection of Flight Recorder Systems	1-K-33
Appendix 1 to OPS 1.710/715	Flight Data Recorder and Aircraft Data Recording Systems (ADRS).....	1-K-35
Appendix 2 to OPS 1.710/715	Data Link Recorder (DLR) Applications to be Recorded.....	1-K-37
Appendix 3 to OPS 1.710/715	Parameter Characteristics for Flight Data Recorders.....	1-K-38
Appendix 1 to OPS 1.710	Flight Crew – Machine Interface Recordings	1-K-46
Appendix 2 to OPS 1.710	Parameter Characteristics for Aircraft Data Recording Systems.....	1-K-48
Appendix 1 to OPS 1.770	Oxygen – Minimum Requirements for Supplemental Oxygen for Pressurised Aeroplanes	1-K-51



Appendix 1 to
OPS 1.775

Supplemental Oxygen for Non-pressurised Aeroplanes 1-K-52

SUBPART L — COMMUNICATION, NAVIGATION AND SURVEILLANCE EQUIPMENT

OPS 1.845	General Introduction	1-L-1
OPS 1.850	Communication Equipment	1-L-1
OPS 1.855	Audio Selector Panel.....	1-L-2
OPS 1.860	Communication Equipment for Operations under VFR over Routes Navigated by Reference to Visual Landmarks.....	1-L-2
OPS 1.865	Communication and Navigation Equipment for Operations under IFR, or under VFR over Routes not Navigated by Reference to Visual Landmarks	1-L-3
OPS 1.866	Transponder Equipment	1-L-4
OPS 1.867	Surveillance Equipment	1-L-5
OPS 1.870	Additional Navigation Equipment for NAT HLA	1-L-5
OPS 1.872	Equipment for operation in Reduced Vertical Separation Minima (RVSM) Airspace.....	1-L-6
OPS 1.873	Electronic Navigation Data Management	1-L-6

SUBPART M — AEROPLANE MAINTENANCE

OPS 1.875	General	1-M-1
OPS 1.880	Terminology	1-M-1
OPS 1.885	Application for and Approval of the Operator's Maintenance System.....	1-M-1
OPS 1.890	Maintenance Responsibility	1-M-2
OPS 1.895	Maintenance Management	1-M-3
OPS 1.900	Quality System	1-M-4
OPS 1.905	Operator's Maintenance Management Exposition.....	1-M-4
OPS 1.910	Operator's Aeroplane Maintenance Programme.....	1-M-6
OPS 1.915	Aeroplane Technical Log.....	1-M-7
OPS 1.920	Continuing Airworthiness Records	1-M-8
OPS 1.930	Continued Validity of the Air Operator Certificate in respect of the Maintenance System	1-M-8
OPS 1.935	Equivalent Safety Case	1-M-9
OPS 1.937	Continuing Airworthiness	1-M-9
Appendix 1 to OPS 1.890	Airworthiness Review in Support of a C of A with a 24 Month Validity	1-M-10

SUBPART N — FLIGHT CREW

OPS 1.940	Composition of Flight Crew.....	1-N-1
OPS 1.941	Flight Crew Training Programmes.....	1-N-2
OPS 1.943	Initial Operator's Crew Resource Management (CRM) Training	1-N-2
OPS 1.945	Conversion Training and Checking	1-N-3
OPS 1.950	Differences Training and Familiarisation Training.....	1-N-4
OPS 1.955	Nomination as Commander.....	1-N-5
OPS 1.960	Commanders holding a Commercial Pilot Licence.....	1-N-5
OPS 1.965	Recurrent Training and Checking	1-N-6
OPS 1.968	Pilot Qualification to Operate in Either Pilot's Seat	1-N-8
OPS 1.970	Recent Experience.....	1-N-8
OPS 1.975	Route and Aerodrome Competence Qualification	1-N-8
OPS 1.978	Alternative Training and Qualification Programme	1-N-10
OPS 1.980	Operation on More than One Type or Variant	1-N-11
OPS 1.981	Operation of Helicopters and Aeroplanes	1-N-11



OPS 1.985	Training Records	1-N-12
Appendix 1 to OPS 1.940	In-flight Relief of Flight Crew Members	1-N-13
Appendix 2 to OPS 1.940	Single-pilot Operations under IFR or at Night.....	1-N-15
Appendix 1 to OPS 1.945	Operator’s Conversion Course	1-N-16
Appendix 1 to OPS 1.965	Recurrent Training and Checking – Pilots	1-N-17
Appendix 2 to OPS 1.965	Recurrent Training and Checking – System Panel Operators.....	1-N-21
Appendix 1 to OPS 1.968	Pilot Qualification to Operate in either Pilot’s Seat.....	1-N-22
Appendix 1 to OPS 1.978	Alternative Training and Qualification Programme	1-N-23
Appendix 1 to OPS 1.980	Operation on More than One Type or Variant	1-N-25

SUBPART O — CABIN CREW

OPS 1.988	Applicability.....	1-O-1
OPS 1.989	Identification	1-O-1
OPS 1.990	Number and Composition of Cabin Crew.....	1-O-1
OPS 1.995	Minimum Requirements.....	1-O-2
OPS 1.1000	Senior Cabin Crew Members	1-O-2
OPS 1.1002	Single Cabin Crew Operations.....	1-O-3
OPS 1.1003	Cabin Crew Training.....	1-O-4
OPS 1.1005	Initial Safety Training	1-O-5
OPS 1.1010	Conversion and Differences Training	1-O-5
OPS 1.1012	Familiarisation.....	1-O-6
OPS 1.1015	Recurrent Training	1-O-6
OPS 1.1020	Refresher Training	1-O-7
OPS 1.1025	Checking	1-O-7
OPS 1.1030	Operation on More than One Type or Variant	1-O-7
OPS 1.1035	Training Records	1-O-8
Appendix 1 to OPS 1.1005	Initial Safety Training	1-O-9
Appendix 1 to OPS 1.1010	Conversion and Differences Training	1-O-12
Appendix 1 to OPS 1.1015	Recurrent Training	1-O-15
Appendix 1 to OPS 1.1020	Refresher Training	1-O-17
Appendix 2 to OPS 1.1005/ 1.1010/1015	Training	1-O-18
Appendix 3 to OPS 1.1005/ 1.1010/1015	Medical Aspects and First Aid Training	1-O-19

SUBPART P — MANUALS, LOGS AND RECORDS

OPS 1.1040	General Rules for Operations Manuals	1-P-1
OPS 1.1045	Operations Manual – Structure and Contents	1-P-2



OPS 1.1050	Aeroplane Flight Manual	1-P-2
OPS 1.1055	Journey Log	1-P-2
OPS 1.1060	Operational Flight Plan	1-P-3
OPS 1.1065	Document Storage Periods	1-P-4
OPS 1.1070	Operator's Maintenance Management Exposition	1-P-4
OPS 1.1071	Aeroplane Technical Log	1-P-5
Appendix 1 to OPS 1.1045	Operations Manual Contents	1-P-6
Appendix 1 to OPS 1.1065	Document Storage Periods	1-P-24

SUBPART Q — FLIGHT/DUTY TIME AND REST REQUIREMENTS

OPS 1.1090	Objective and Scope	1-Q-1
OPS 1.1095	Definitions	1-Q-2
OPS 1.1100	Flight and Duty Limitations	1-Q-5
OPS 1.1105	Maximum Daily Flight Duty Period (FDP)	1-Q-5
OPS 1.1110	Rest	1-Q-7
OPS 1.1115	Extension of Flight Duty Period due to In-flight Rest	1-Q-8
OPS 1.1120	Unforeseen Circumstances in Actual Flight Operations — Commander's Discretion	1-Q-8
OPS 1.1122	Unforeseen Circumstances in Flight Operations — Delayed Reporting	1-Q-9
OPS 1.1123	Reserve	1-Q-10
OPS 1.1125	Standby	1-Q-10
OPS 1.1130	Nutrition	1-Q-11
OPS 1.1135	Flight Duty, Duty and Rest Period Records	1-Q-11
OPS 1.1140	Fatigue Management	1-Q-12

SUBPART R — TRANSPORT OF DANGEROUS GOODS BY AIR

OPS 1.1145	General	1-R-1
OPS 1.1150	Terminology	1-R-1
OPS 1.1155	Operators with a Specific Approval for the Transport of Dangerous Goods as Cargo	1-R-3
OPS 1.1157	Operators with No Specific Approval for the Transport of Dangerous Goods as Cargo	1-R-4
OPS 1.1160	Scope	1-R-4
OPS 1.1165	Limitation on the Transport of Dangerous Goods	1-R-5
OPS 1.1195	Acceptance of Dangerous Goods	1-R-5
OPS 1.1200	Inspection for Damage, Leakage or Contamination	1-R-6
OPS 1.1205	Removal of Contamination	1-R-6
OPS 1.1210	Loading Restrictions	1-R-7
OPS 1.1215	Provision of Information	1-R-7
OPS 1.1220	Training Programmes	1-R-8
OPS 1.1225	Dangerous Goods Incident and Accident Reports	1-R-9
Appendix 1 to OPS 1.1225	Dangerous Goods Incident and Accident Reports	1-R-10

SUBPART S — SECURITY

OPS 1.1235	Security Requirements	1-S-1
OPS 1.1240	Training Programmes	1-S-1
OPS 1.1245	Reporting Acts of Unlawful Interference	1-S-1
OPS 1.1250	Aeroplane Search Procedure Checklist	1-S-1
OPS 1.1255	Flight Crew Compartment Security	1-S-1



SECTION 2 - ADVISORY CIRCULARS (AC), ACCEPTABLE MEANS OF COMPLIANCE (AMC)

General i
 Presentation ii

AC/AMC B – GENERAL

AC to Appendix 1 to OPS 1.005(a) Operations of Performance Class B Aeroplanes 2-B-1
 Attachment 1 to AC to Appendix 1 to OPS 1.005(a) Technical Log example 2-B-3
 AC OPS 1.035 Quality System 2-B-5
 AMC OPS 1.035 Quality System – Organisation Examples 2-B-13
 AMC OPS 1.037 Safety Management System 2-B-13
 AC OPS 1.037(c) Occurrence Reporting Scheme 2-B-13
 AC OPS 1.037(d) Flight Data Monitoring Programme 2-B-14
 AMC OPS 1.037(f) Flight Safety Documents System 2-B-16
 AMC OPS 1.037(g) RFFS Category 2-B-18
 AMC OPS 1.065 Carriage of Weapons of War and Munitions of War 2-B-22
 AMC OPS 1.070 Carriage of Sporting Weapons 2-B-22
 AC OPS 1.085(e)(3) Crew Responsibilities 2-B-23
 AC OPS 1.085(f)(9) Sterile Flight Crew Compartment 2-B-23
 AC OPS 1.125 Documents to be Carried 2-B-23
 AMC OPS 1.130 Manuals to be Carried 2-B-24
 AC OPS 1.160(a)(1) and (2) Preservation of Recordings 2-B-24
 AC OPS 1.165(c)(2) Leasing of Aeroplanes between the operator and any Entity 2-B-24
 Appendix to AC OPS 1.037(d) Flight Data Monitoring Programme 2-B-25

AC/AMC C — OPERATOR CERTIFICATION & SUPERVISION

AMC OPS 1.175 The Management Organisation of an AOC Holder 2-C-1
 AMC OPS 1.175(c)(1) Principal Place of Business 2-C-1
 AC OPS 1.175(h) Accountable Manager 2-C-1
 AMC OPS 1.175(i) Nominated Persons - Competence 2-C-2
 AMC OPS 1.175(i) Nominated Persons 2-C-2
 AMC OPS 1.175(i) Nominated Persons – Small Organisations 2-C-3
 AC OPS 1.175(l) Combination of Nominated Post Holder’s Responsibilities 2-C-3
 AC OPS 1.175(l) & (m) Employment of Staff 2-C-3
 AMC OPS 1.185(b) Maintenance Management Exposition details 2-C-3

AC/AMC D — OPERATIONAL PROCEDURES

AC OPS 1.195 Operational Control 2-D-1
 AMC OPS 1.197 Aircraft Tracking 2-D-1
 AC OPS 1.205 Competence of Operations Personnel 2-D-1
 AMC OPS 1.210(a) Establishment of Procedures 2-D-1
 AMC OPS 1.210(b) Establishment of Procedures 2-D-1
 AC OPS 1.216 In-flight Operational Instructions 2-D-2
 AC OPS 1.235 Noise Abatement Departure Procedures (NADP) 2-D-2
 AC OPS 1.243 Operations in Areas with Specified Navigation Performance Requirements... 2-D-3
 AMC OPS 1.245(a) Maximum Distance from an Adequate Aerodrome for Aeroplanes without EDTO Approval 2-D-3
 AMC OPS 1.245(a)(2)(ii) Operation of Non-EDTO Approved Twin Turbojet Aeroplanes between 120 and 180 minutes from an Adequate Aerodrome for Aeroplanes without EDTO Approval 2-D-3
 AMC OPS 1.245(d)(1) Operation by Aeroplanes with Turbine Engines beyond 60 minutes to an en-route Alternate Aerodrome 2-D-7
 AMC OPS 1.246 Extended Diversion Time Operations 2-D-9
 AMC OPS 1.250 Establishment of Minimum Flight Altitudes 2-D-15
 AC OPS 1.255 Contingency Fuel Statistical Method 2-D-18
 AC OPS 1.260 Carriage of Persons with Reduced Mobility 2-D-18
 AMC OPS 1.270 Cargo carriage in the Passenger Cabin 2-D-18
 AC OPS 1.280 Passenger Seating 2-D-19
 AMC OPS 1.280 Passenger Seating 2-D-19



AC OPS 1.297(b)(2)	Planning Minima for Alternate Aerodromes	2-D-19
AMC OPS 1.297	Application of Aerodrome Forecasts	2-D-21
AMC OPS 1.300	Submission of ATS Flight Plan	2-D-23
AMC OPS 1.305	Re/defueling with Passengers Embarking, on Board or Disembarking	2-D-23
AMC OPS 1.307	Refuelling/Defueling with Wide-cut Fuel	2-D-23
AC OPS 1.308	Push Back and Towing	2-D-24
AC OPS 1.310(a)(3)	Controlled Rest on Flight Deck	2-D-24
AMC OPS 1.310(b)	Cabin Crew Seating Positions	2-D-25
AC OPS 1.311(b)(i)	Minimum Number of Cabin Crew Required to be on Board during Disembarkation	2-D-25
AC OPS 1.345	Ice and Other Contaminants - Ground Procedures	2-D-25
AC OPS 1.346	Flight in Expected or Actual Icing Conditions	2-D-32
AC OPS 1.390(a)(1)	Assessment of Cosmic Radiation	2-D-33
AC OPS 1.390(a)(2)	Working Schedules and Record Keeping	2-D-34
AC OPS 1.390(a)(3)	Explanatory Information	2-D-34
AC OPS 1.398	Use of Airborne Avoidance System (ACAS)	2-D-34
AMC OPS 1.400	Approach and Landing Conditions	2-D-34
Appendix 1 to AMC OPS 1.245(a)(2)	Power Supply to Essential Services	2-D-35

AC/AMC E — ALL WEATHER OPERATIONS

AC OPS 1.430	Continuous Descent Final Approach (CDFA)	2-E-1
AMC OPS 1.430	Documents containing information Related to All Weather Operations	2-E-10
AMC to Appendix 1 to OPS 1.430 Table 6a	Effect on Landing Minima of Temporarily Failed or Downgraded Ground Equipment	2-E-10
AC OPS to Appendix 1 to OPS 1.430(d)	Aerodrome Operating Minima - Determination of RVR/Visibility Minima for Category I, APV and Non-precision Approaches	2-E-15
AMC to Appendix 1 to OPS 1.430 (e) & (f)	Establishment of Minimum RVR for Category II and III Operations	2-E-16
AMC to Appendix 1 to OPS 1.430, paragraph (f)(4)	Crew Actions in Case of Autopilot Failure at or Below Decision Height in Fail-passive Category III Operations	2-E-18
AC OPS to Appendix 1 to OPS 1.430(g)	Enhanced Vision Systems	2-E-18
AC to Appendix 1 to OPS 1.430, paragraph (i)	Visual Manoeuvring (Circling)	2-E-19
AC to Appendix 1 to OPS 1.440	Operational Demonstrations	2-E-22
AMC to Appendix 1 to OPS 1.440(b)	Criteria for a Successful CAT II/III Approach & Autoland	2-E-23
AMC to Appendix 1 to OPS 1.450(g)(1)	Low Visibility Operations - Training & Qualifications	2-E-23

AC/AMC F - PERFORMANCE GENERAL

AMC OPS 1.475(b)	Landing - Reverse Thrust Credit	2-F-1
AC OPS 1.475(b)	Factoring of Automatic Landing Distance Performance Data (Performance Class A Aeroplanes Only)	2-F-1

AC/AMC G — PERFORMANCE CLASS A

AMC OPS 1.485(b)	General – Wet and Contaminated Runway Data	2-G-1
AMC OPS 1.490(c)(3)	Take-off – Runway Surface Condition	2-G-1
AMC OPS 1.490(c)(6)	Loss of Runway Length due to Alignment	2-G-1
AMC OPS 1.495(a)	Take-off Obstacle Clearance	2-G-2
AMC OPS 1.495(c)(4)	Take-off Obstacle Clearance	2-G-3
AMC OPS 1.495 (d)(1) & (e)(1)	Required Navigational Accuracy	2-G-3
AMC OPS 1.495(f)	Engine Failure Procedures	2-G-4
AMC OPS 1.500	En-Route – One-engine-inoperative	2-G-4
AMC OPS 1.510(b) and (c)	Landing – Destination and Alternate Aerodromes	2-G-5
AMC OPS 1.510 & 1.515	Landing – Destination and Alternate Aerodromes - Dry Runways	2-G-5
AMC OPS 1.515(c)	Landing – Dry Runway	2-G-5

AC/AMC H — PERFORMANCE CLASS B

AMC OPS 1.526	Single-engine Operations at Night and/or in IMC	2-H-1
AMC OPS 1.526(i)	Single-engine Operations - Forced Landing Areas	2-H-3



AMC OPS 1.530(c)(4)	Take-off Performance Correction Factors.....	2-H-3
AMC OPS 1.530(c)(4)	Take-off Performance Correction Factors.....	2-H-3
AMC OPS 1.530(c)(5)	Runway Slope	2-H-3
AMC OPS 1.535	Obstacle Clearance in Limited Visibility	2-H-3
AMC OPS 1.535(a)	Take-off Flight Path Construction	2-H-4
AMC OPS 1.535(a)	Take-off Flight Path Construction	2-H-5
AMC OPS 1.540	En-Route	2-H-6
AMC OPS 1.542	En-route – Single-engine Aeroplanes	2-H-6
AMC OPS 1.542(a)	En-Route - Single-engine Aeroplanes	2-H-7
AMC OPS 1.545 & 1.550	Landing Destination and Alternate Aerodromes - Dry runway	2-H-7
AMC OPS 1.550(b)(3)	Landing Distance Correction Factors.....	2-H-7
AMC OPS 1.550(b)(4)	Runway Slope.....	2-H-7
AMC OPS 1.550(c)	Landing – Dry Runway.....	2-H-7
AMC OPS 1.555(a)	Landing on Wet Grass Runways	2-H-8

AC/AMC I — PERFORMANCE CLASS C

AMC OPS 1.565(d)(3)	Take-off	2-I-1
AMC OPS 1.565(d)(6)	Loss of Runway Length due to Alignment	2-I-1
AMC OPS 1.565(b)(4)	Runway Slope	2-I-2
AMC OPS 1.570(d)	Take-off Flight Path.....	2-I-3
AMC OPS 1.570(e)(1) & (f)(1)	Required Navigational Accuracy.....	2-I-3
AMC OPS 1.580	En-Route – One-engine-inoperative	2-I-4
AMC OPS 1.590 & 1.595	Landing – Destination and Alternate Aerodromes - Dry Runways	2-I-4
AMC OPS 1.595(b)(3)	Landing Distance Correction Factors.....	2-I-4
AMC OPS 1.595(b)(4)	Runway Slope	2-I-5
AMC OPS 1.595(c)	Landing Runway	2-I-5

AC/AMC J — MASS & BALANCE

AMC OPS 1.605(e)	Fuel Density	2-J-1
AC OPS 1.605	Mass Values.....	2-J-1
AMC to Appendix 1 to OPS 1.605	Accuracy of Weighing Equipment.....	2-J-1
AMC to Appendix 1 to OPS 1.605	Centre of Gravity Limits	2-J-1
AMC OPS 1.620(a)	Passenger Mass Established by Use of a Verbal Statement	2-J-2
AMC OPS 1.620(d)(2)	Holiday Charter	2-J-2
AMC OPS 1.620(g)	Statistical Evaluation of Passenger and Baggage Mass Data.....	2-J-2
AMC OPS 1.620(h) & (i)	Adjustment of Standard Masses.....	2-J-3
AMC to Appendix 1 to OPS 1.620(g)	Guidance on Passenger Weighing Surveys	2-J-3
AMC to Appendix 1 to OPS 1.620(g)	Guidance on Passenger Weighing Surveys	2-J-3
AMC to Appendix 1 to OPS 1.625	Mass and Balance Documentation	2-J-5

AC/AMC K — INSTRUMENTS AND EQUIPMENT

AMC OPS 1.630	Instruments and Equipment - Approval and Installation	2-K-1
AMC OPS 1.650/1.652	Flight and Navigational Instruments and Associated Equipment	2-K-1
AMC OPS 1.650/1.652	Flight and Navigational Instruments and Associated Equipment	2-K-2
AMC OPS 1.650(i)&1.652(i)	Flight and Navigational Instruments and Associated Equipment	2-K-2
AMC OPS 1.650(p)/1.652(s)	Headset, Boom Microphone and Associated Equipment	2-K-3
AMC OPS 1.652(d) & (k)(2)	Flight and Navigational Instruments and Associated Equipment	2-K-3
AMC OPS 1.668	Airborne Collision Avoidance System	2-K-3
AC OPS 1.680(a)(2)	Quarterly Radiation Sampling	2-K-3
AMC OPS 1.690(b)(6)	Crew Member Interphone System	2-K-3
AMC OPS 1.690(b)(7)	Crew Member Interphone System	2-K-3
AC OPS 1.700	Cockpit Voice Recorders	2-K-4
AC OPS 1.710/OPS 1.715	Flight Data Recorders.....	2-K-4
AC OPS 1.730(a)(3)	Seats, Seat Safety Belts, Harnesses and Child Restraint Devices	2-K-4
AMC OPS 1.745	First-Aid Kits.....	2-K-6
AMC OPS 1.755	Emergency Medical Kit	2-K-7
AMC OPS 1.760	First-aid Oxygen.....	2-K-7



AMC OPS 1.770	Supplemental Oxygen – Pressurised Aeroplanes	2-K-7
AC OPS 1.770(b)(2)(v)	Supplemental Oxygen - Pressurised Aeroplanes	2-K-8
	(Not certificated to fly above 25000ft)	
AMC OPS 1.790	Hand Fire Extinguishers	2-K-8
AMC OPS 1.810	Megaphones	2-K-9
AC OPS 1.820	Emergency Locator Transmitter (ELT)	2-K-9
AMC OPS 1.820	Automatic deployable flight recorder (ADFR)	2-K-9
AC OPS 1.821	Location of an Aircraft in Distress	2-K-10
AMC OPS 1.825	Life Jackets	2-K-11
AMC OPS 1.830(b)(2)	Life-rafts and ELT for Extended Overwater Flights	2-K-11
AMC OPS 1.835	Survival Equipment	2-K-11
AMC OPS 1.835(c)	Survival Equipment	2-K-12

AC/AMC L — COMMUNICATION, NAVIGATION AND SURVEILLANCE EQUIPMENT

AMC OPS 1.845	Communication and Navigation Equipment -Approval and Installation	2-L-1
AMC OPS 1.865	Combinations of Instruments and Integrated Flight Systems	2-L-1
AMC OPS 1.865(d)(1)(i)	IFR Flight Without ADF System	2-L-1
AC OPS 1.865(f)	FM Immunity Equipment Standards	2-L-2
AC OPS 1.865(g)	HF – Equipment on Certain NAT HLA Routes	2-L-2
AC OPS 1.870	Additional Navigation Equipment for Operations in NAT HLA	2-L-2
AC OPS 1.873	Electronic Navigation Data Management	2-L-2

AC/AMC M — AEROPLANE MAINTENANCE

AMC OPS 1.875	General	2-M-1
AMC OPS 1.885(a)	Application for and Approval of the Operator's Maintenance System	2-M-1
AMC OPS 1.885(b)	Application for and Approval of the Operator's Maintenance System	2-M-1
AMC OPS 1.890(a)	Maintenance Responsibility	2-M-2
AMC OPS 1.890(a)(1)	Maintenance Responsibility	2-M-2
AMC OPS 1.890(a)(1)	Maintenance Responsibility	2-M-3
AMC OPS 1.890(a)(2)	Maintenance Responsibility	2-M-3
AMC OPS 1.890(a)(3)	Maintenance Responsibility	2-M-3
AMC OPS 1.890(a)(4)	Maintenance Responsibility	2-M-3
AMC OPS 1.890(a)(5)	Maintenance Responsibility	2-M-3
AMC OPS 1.890(a)(6)	Maintenance Responsibility	2-M-4
AMC OPS 1.895(a)	Maintenance Management	2-M-4
AMC OPS 1.895(b)	Maintenance Management	2-M-9
AMC OPS 1.895(c)	Maintenance Management	2-M-9
AMC OPS 1.895(c)	Maintenance Management	2-M-9
AMC OPS 1.895(d)	Maintenance Management	2-M-9
AMC OPS 1.895(e)	Maintenance Management	2-M-10
AMC OPS 1.895(f & g)	Maintenance Management	2-M-10
AMC OPS 1.895(h)	Maintenance Management	2-M-10
AMC OPS 1.900	Quality System	2-M-10
AMC OPS 1.900	Quality System	2-M-11
AMC OPS 1.905(a)	Maintenance Management Exposition	2-M-11
AMC OPS 1.910(a)	Operator's Aeroplane Maintenance	2-M-12
AMC OPS 1.910(f)	Operator's Aeroplane Maintenance Programme	2-M-13
AMC OPS 1.910(g)	Operator's Aeroplane Maintenance Programme	2-M-13
AMC OPS 1.910(h)	Operator's Aeroplane Maintenance	2-M-13
AMC OPS 1.915	Operator's Aeroplane Technical Log	2-M-14
AMC OPS 1.920	Continuing Airworthiness Records	2-M-15
AMC OPS 1.920(b)(6)	Continuing Airworthiness Records	2-M-16
AMC OPS 1.920(c)	Continuing Airworthiness Records	2-M-16
AMC OPS 1.930	Continued Validity of the Air Operator Certificate in Respect of the Maintenance System	2-M-17
AMC OPS 1.935	Equivalent Safety Case	2-M-17
Appendix 1 to AMC OPS 1.905(a)	Maintenance Management Suggested Format and Required Contents	2-M-18
Appendix 1 to AMC OPS 1.910(a), (b), (c) and (d)	Operator's Aeroplane Maintenance Programme	2-M-22

AC/AMC N — FLIGHT CREW

AMC OPS 1.940(a)(4)	Crewing of Inexperienced Flight Crew Members	2-N-1
AMC OPS 1.945	Conversion Course Syllabus	2-N-1



AMC OPS 1.945	Line Flying under Supervision.....	2-N-3
AC OPS (AMC) 1.943/ 1.945 (a)(9) /1.955(b)(6)/1.965(e)	Crew Resource Management (CRM).....	2-N-3
AC OPS (AMC) 1.943/1.945(a) (9)/1.955(b)(6)/1.965(e)	Crew Resource Management (CRM).....	2-N-6
AMC OPS 1.945(a)(9)	Crew Resource Management - Use of Automation	2-N-7
AMC OPS 1.965(c)	Line Checks	2-N-7
AMC OPS 1.965(d)	Emergency and Safety Equipment Training	2-N-7
AMC OPS 1.965	Recurrent Training and Checking	2-N-7
AMC to Appendix 1 to OPS 1.965	Pilot Incapacitation Training	2-N-8
AMC OPS 1.970	Recency	2-N-8
AMC OPS 1.970(a)(2)	Co-pilot Proficiency	2-N-8
AMC OPS 1.975	Route and Aerodrome Competence Qualification	2-N-8
AC OPS 1.978	Terminology	2-N-9
AC to Appendix 1 to OPS 1.978(b)(1)	Requirements, Scope and Documentation of the Programme	2-N-10
AC to Appendix 1 to OPS 1.978(b)(2)	Task Analysis	2-N-10
AC to Appendix 1 to OPS 1.978(b)(3)	Training Programme	2-N-10
AC to Appendix 1 to OPS 1.978(b)(4)	Training Personnel	2-N-11
AC to Appendix 1 to OPS 1.978(b)(5)	Feedback Loop	2-N-11
AC to Appendix 1 to OPS 1.978(b)(6)	Crew Performance Measurement and Evaluation	2-N-12
AC to Appendix 1 to OPS 1.978(b)(9)	Data Monitoring/Analysis Programme	2-N-12
AC to Appendix 1 to OPS 1.978(c)(1)(i)	Safety Case	2-N-13
AMC OPS 1.980	Operation on More than one Type or Variant	2-N-14
AMC OPS 1.980(b)	Methodology - Use of Operator Difference Requirement (ODR) Tables	2-N-16
AMC OPS 1.980(b)	Operation on More than One Type or Variant Philosophy and Criteria	2-N-18
AMC OPS 1.985	Training Records.....	2-N-20
AC/AMC O — CABIN CREW		
AMC OPS 1.988	Additional Crew Members Assigned to Specialist Duties	2-O-1
AMC OPS 1.990	Number and Composition of Cabin Crew	2-O-1
AMC OPS 1.995(b)	Minimum Requirements	2-O-2
AMC OPS 1.1000(c)	Senior Cabin Crew Training	2-O-2
AC OPS 1.1005/1.1010/1.1015	Crew Resource Management Training	2-O-3
AMC OPS 1.1012	Familiarisation	2-O-5
AC OPS 1.1005/1.1010/ 1.1015/1.1020	Representative Training Devices	2-O-6
AMC OPS 1.1015	Recurrent Training	2-O-6
AMC OPS 1.1020	Refresher Training	2-O-6
AMC OPS 1.1020(a)	Refresher Training	2-O-7
AMC OPS 1.1025	Checking	2-O-7
AC OPS 1.1030	Operation on More than One Type or Variant	2-O-7
AMC OPS 1.1035	Training Records.....	2-O-8
AMC to Appendix 1 to OPS 1.1005/1.1010/1.1015 /1.1020	Crowd Control	2-O-8
AMC to Appendix 1 to OPS 1.1005/1.1010/1.1015/ 1.1020	Training Methods	2-O-9
AMC to Appendix 1 to OPS 1.1010/1.1015	Conversion and Recurrent Training	2-O-9
AC/AMC P — MANUALS, LOGS & RECORDS		
AMC OPS 1.1040(b)	Elements of the Operations Manual Subject to Approval	2-P-1
AMC OPS 1.1040(c)	Operations Manual - Language	2-P-1



AMC OPS 1.1045	Operations Manual Contents	2-P-2
AMC OPS 1.1045(c)	Operations Manual Structure	2-P-2
AMC OPS 1.1055(a)(12)	Signature or Equivalent.....	2-P-3
AMC OPS 1.1055(b)	Journey Log	2-P-3
AMC to Appendix 1 to OPS 1.1045	Operations Manual Contents	2-P-3

AC/AMC Q — FLIGHT/DUTY TIME AND REST REQUIREMENTS

AC OPS 1.1140	Fatigue Risk Management System	2-Q-1
---------------	--------------------------------------	-------

AC/AMC R — TRANSPORT OF DANGEROUS GOODS BY AIR

AC OPS (AMC) 1.1150(a)(5) & (a)(6)	Terminology - Dangerous Goods Accident and Dangerous Good Incident	2-R-1
AC OPS 1.1160(a)	Medical Aid for a Patient	2-R-1
AC OPS (AMC) 1.1160(b)	Dangerous Goods on an Aeroplane in Accordance with the Relevant Regulations or for Operating Reasons.....	2-R-1
AC OPS (AMC) 1.1160(c)(1)	Scope – Dangerous Goods Carried by Passengers or Crew	2-R-1
AC OPS (AMC) 1.1165(b)	Exemption and Approval Procedures of the Technical Instructions	2-R-3
AC OPS 1.1215(c)(1)	Information to the Commander	2-R-4
AC OPS (AMC) 1.1215(e)	Information in the Event of an In-flight emergency	2-R-4
AC OPS (AMC) 1.1220	Training	2-R-4
AC OPS (AMC) 1.1225	Dangerous Goods Incident and Accident Reports.....	2-R-5

AC S — SECURITY

AC OPS 1.1240	Training Programmes.....	2-S-1
---------------	--------------------------	-------



This Page Intentionally Left Blank

**SUBPART A****APPLICABILITY****OPS 1.001 Applicability**

OPS 1 prescribes the requirements applicable to the operation of any civil aeroplane for the purpose of commercial air transportation by any operator whose principal place of business and, if any, its registered office is in the Republic of San Marino.

OPS 1 does not apply;

- (a) to aeroplanes when used in military, customs and police services; nor
- (b) to parachute dropping and fire fighting flights, or to associated positioning and return flights in which the persons carried are those who would normally be carried on parachute dropping or fire fighting; nor
- (c) to flights immediately before, during, or immediately after an aerial work activity provided these flights are connected with that aerial work activity and in which, excluding crew members, no more than 6 persons indispensable to the aerial work activity are carried.

OPS 1.002 Air Operating Licence

In addition to an Air Operating Certificate issued under Subpart C of these regulations, no undertaking established in San Marino shall be permitted to carry by air passengers, mail and/or cargo for remuneration and/or hire unless it has been granted the appropriate air operating licence by the Authority.



This Page Intentionally Left Blank

**SUBPART B****GENERAL****OPS 1.005 General**

- (a) The operator shall not operate an aeroplane for the purpose of commercial air transportation other than in accordance with OPS 1. For operations of Performance Class B aeroplanes alleviated requirements can be found in Appendix 1 to OPS 1.005(a).
- (b) The operator shall comply with the applicable airworthiness requirements for aeroplanes operated for the purpose of commercial air transportation.
- (c) Each aeroplane shall be operated in compliance with the terms of its Certificate of Airworthiness and within the approved limitations contained in its Aeroplane Flight Manual.
- (d) All Synthetic Training Devices (STD), such as flight simulators or flight training devices, replacing an aeroplane for training and/or checking purposes are to be qualified in accordance with the requirements applicable to synthetic training devices. The operator intending to use such STDs must obtain approval from the Authority.

OPS 1.010 Exemptions

The Authority may exceptionally grant an exemption from the provisions of OPS 1 when satisfied that there is a need and subject to compliance with any supplementary condition the Authority considers necessary in order to ensure an acceptable level of safety in the particular case.

OPS 1.015 Operational Directives

- (a) The Authority may direct by means of an Operational Directive that an operation shall be prohibited, limited or subject to certain conditions, in the interests of safe operations.
- (b) Operational Directives state:
 - (1) The reason for issue;
 - (2) Applicability and duration; and
 - (3) Action required by the operator(s).
- (c) Operational Directives are supplementary to the provisions of OPS 1.

OPS 1.020 Laws, Regulations and Procedures – Operator’s Responsibilities

- (a) The operator shall meet and maintain the requirements established by the States in which the operations are conducted.
- (b) The operator must ensure that:
 - (1) All employees are made aware that they shall comply with the laws, regulations and procedures of those States in which operations are conducted and which are pertinent to the performance of their duties; and



- (2) All crew members are familiar with the laws, regulations and procedures pertinent to the performance of their duties prescribed for the areas to be traversed, the aerodromes to be used and the air navigation facilities relating thereto.
- (3) The operator shall ensure that other members of the flight crew are familiar with such of these laws, regulations and procedures as are pertinent to the performance of their respective duties in the operation of the aeroplane.

OPS 1.023 Compliance by a foreign operator with laws, regulations and procedures

- (a) The Authority shall recognise as valid an air operator certificate issued by another Contracting State, provided that the requirements under which the certificate was issued are at least equal to the applicable Standards specified in ICAO Annex 6, Part I.
- (b) The Authority shall establish a programme with procedures for the surveillance of operations in their territory by a foreign operator and for taking appropriate action when necessary to preserve safety.
- (c) The operator shall meet and maintain the requirements established by the Authority for operations conducted in the territory of San Marino.
- (d) When the Authority identifies a case of non-compliance or suspected non-compliance by a foreign operator with laws, regulations and procedures applicable within the territory of San Marino, or a similar serious safety issue with that operator, the Authority shall immediately notify the operator and, if the issue warrants it, the State of the Operator. Where the State of the Operator and the State of Registry are different, such notification shall also be made to the State of Registry, if the issue falls within the responsibilities of that State and warrants a notification.
- (e) In the case of notification to States, if the issue and its resolution warrant it, the Authority shall engage in consultations with the State of the Operator and the State of Registry, as applicable, concerning the safety standards maintained by the operator.

OPS 1.025 Common Language

- (a) The operator must ensure that all crew members can communicate in a common language.
- (b) The operator must ensure that all operations personnel are able to understand the language in which those parts of the Operations Manual which pertain to their duties and responsibilities are written.

OPS 1.030 Minimum Equipment Lists – Operator’s Responsibilities

- (a) The operator shall establish, for each aeroplane, a Minimum Equipment List (MEL) approved by the Authority. This shall be based upon, but no less restrictive than, the relevant Master Minimum Equipment List (MMEL) (if this exists) accepted by the Authority.
- (b) The operator shall not operate an aeroplane other than in accordance with the MEL unless permitted by the Authority. Any such permission will in no circumstances permit operation outside the constraints of the MMEL.
- (c) Where the Authority is not the State of Registry, the Authority shall ensure that the MEL does not affect the aeroplane’s compliance with the airworthiness requirements applicable in the State of Registry.

**OPS 1.035 Quality System**

(See AC OPS 1.035 and AMC OPS 1.035)

- (a) The operator shall establish one Quality System and designate one Quality Manager to monitor compliance with, and the adequacy of, procedures required to ensure safe operational practices and airworthy aeroplanes. Compliance monitoring must include a feed-back system to the Accountable Manager (See also OPS 1.175(h)) to ensure corrective action as necessary.
- (b) The Quality System must include a quality assurance programme that contains procedures designed to verify that all operations are being conducted in accordance with all applicable requirements, standards and procedures.
- (c) The Quality System and the Quality Manager must be acceptable to the Authority.
- (d) The Quality System must be described in relevant documentation.
- (e) Notwithstanding sub-paragraph (a) above, the Authority may accept the nomination of two Quality Managers, one for operations and one for maintenance provided that the operator has designated one Quality Management Unit to ensure that the Quality System is applied uniformly throughout the entire operation.

OPS 1.037 Safety Management System

(See Appendix 1 to OPS 1.037)

(See AMC OPS 1.037)

- (a) The SMS of the operator shall be established in accordance with the framework elements contained in Appendix 1 to OPS 1.037 and be commensurate with the size of the operator and the complexity of its aviation services.
- (b) The SMS of a certified operator of aeroplanes authorised to conduct international commercial air transport, in accordance with these regulations, shall be made acceptable to the State of the Operator.
- (c) The system shall include an occurrence reporting scheme to enable the collation and assessment of relevant incident and accident reports in order to identify adverse trends or to address deficiencies in the interests of flight safety. The scheme shall protect the identity of the reporter and include the possibility that reports may be submitted anonymously. (See AC OPS 1.037(c))
- (d) The operator of an aircraft of a maximum certificated take-off mass over 27000 kg shall establish and maintain a flight data analysis programme as part of its safety management system. (See AC OPS 1.037(d) and Appendix to AC OPS 1.037(d))
- (e) The flight data analysis programme in paragraph (d) shall contain adequate safeguards to protect the source(s) of the data in accordance with the principles of Appendix 1 to OPS 1.161.

Note: The operator may contract the operation of a flight data analysis programme to another party while retaining overall responsibility for the maintenance of such a programme.

- (f) The operator shall establish a flight safety documents system, for the use and guidance of operational personnel, as part of its safety management system. (See AMC OPS 1.037(f))
- (g) The operator shall, as part of its safety management system, assess the level of rescue and fire fighting service (RFFS) protection available at any aerodrome intended to be specified in the operational flight plan in order to ensure that an acceptable level of protection is available for the



aeroplane intended to be used. (See AMC OPS 1.037(g)).

- (h) Information related to the level of RFFS protection that is deemed acceptable by the operator shall be contained in the Operations Manual.

OPS 1.040 Crew Members

- (a) The operator shall ensure that all operating flight and cabin crew members have been trained in, and are proficient to perform, their assigned duties.
- (b) Where there are crew members, other than cabin crew members, who carry out their duties in the passenger compartment of an aeroplane, the operator shall ensure that these:
 - (1) are not confused by the passengers with the cabin crew members;
 - (2) do not occupy required cabin crew assigned stations;
 - (3) do not impede the cabin crew members in their duties.

OPS 1.050 Search and Rescue Information

- (a) The operator shall ensure that essential information pertinent to the intended flight concerning search and rescue services is easily accessible on the flight deck.
- (b) All aeroplanes on all flights shall be equipped with the ground-air signal codes for search and rescue purposes.

OPS 1.055 Information on Emergency and Survival Equipment Carried

The operator shall ensure that there are available for immediate communication to rescue coordination centres, lists containing information on the emergency and survival equipment carried on board all of his aeroplanes. The information shall include, as applicable, the number, colour and type of life-rafts and pyrotechnics, details of emergency medical supplies, water supplies and the type and frequencies of emergency portable radio equipment.

OPS 1.060 Ditching

The operator shall not operate an aeroplane with an approved passenger seating configuration of more than 30 passengers on overwater flights at a distance from land suitable for making an emergency landing, greater than 120 minutes at cruising speed, or 400 nautical miles, whichever is the lesser, unless the aeroplane complies with the ditching requirements prescribed in the applicable airworthiness code.

OPS 1.065 Carriage of Weapons of War and Munitions of War

(See AMC OPS 1.065)

- (a) The operator shall not transport weapons of war and munitions of war by air unless an approval to do so has been granted by all States concerned.
- (b) The operator shall ensure that weapons of war and munitions of war are:
 - (1) stowed in the aeroplane in a place which is inaccessible to passengers during flight; and



- (2) in the case of firearms, unloaded,

unless, before the commencement of the flight, approval has been granted by all States concerned that such weapons of war and munitions of war may be carried in circumstances that differ in part or in total from those indicated in this sub-paragraph.

- (c) The operator shall ensure that the commander is notified before a flight begins of the details and location on board the aeroplane of any weapons of war and munitions of war intended to be carried.

OPS 1.070 Carriage of Sporting Weapons and Ammunition

(See AMC OPS 1.070)

- (a) The operator shall take all reasonable measures to ensure that any sporting weapons intended to be carried by air are reported to him.
- (b) The operator accepting the carriage of sporting weapons shall ensure that they are:
- (1) stowed in the aeroplane in a place which is inaccessible to passengers during flight unless the Authority has determined that compliance is impracticable and has accepted that other procedures might apply; and
 - (2) in the case of firearms or other weapons that can contain ammunition, unloaded.
- (c) Ammunition for sporting weapons may be carried in passengers' checked baggage, subject to certain limitations, in accordance with the Technical Instructions as defined in OPS 1.1150(a)(15).

OPS 1.075 Method of Carriage of Persons

The operator shall take all reasonable measures to ensure that no person is in any part of an aeroplane in flight which is not a part designed for the accommodation of persons unless temporary access has been granted by the commander to any part of the aeroplane:

- (a) for the purpose of taking action necessary for the safety of the aeroplane or of any person, animal or goods therein; or
- (b) in which cargo or stores are carried, being a part which is designed to enable a person to have access thereto while the aeroplane is in flight.

OPS 1.085 Crew Responsibilities

- (a) A crew member shall be responsible for the proper execution of his/her duties that:
- (1) are related to the safety of the aeroplane and its occupants; and
 - (2) are specified in the instructions and procedures laid down in the Operations Manual.
- (b) A crew member shall:
- (1) report to the commander any fault, failure, malfunction or defect which he/she believes may affect the airworthiness or safe operation of the aeroplane including emergency systems; and



- (2) report to the commander any incident that endangered, or could have endangered, the safety of operation; and
 - (3) make use of the operator's occurrence reporting schemes in accordance with OPS 1.037(c). In all such cases, a copy of the report(s) shall be communicated to the commander concerned.
 - (4) not engage in any activity during a critical phase of flight which could distract any flight crewmember from the performance of his or her duties or which could interfere in any way with the proper conduct of those duties.
- (c) Nothing in paragraph (b) above shall oblige a crew member to report an occurrence which has already been reported by another crew member.
- (d) A crew member shall not perform duties on an aeroplane;
- (1) while under the influence of any drug that may affect his/her faculties in a manner contrary to safety;
 - (2) following deep water diving except when a reasonable time period has elapsed;
 - (3) following blood donation except when a reasonable time period has elapsed;
 - (4) if applicable medical requirements are not fulfilled, or if he/she is in any doubt of being able to accomplish his assigned duties; or
 - (5) if he/she knows or suspects that he/she is suffering from fatigue, or feels unfit to the extent that the flight may be endangered.
- (e) A crew member shall be subject to appropriate requirements on the consumption of alcohol which shall be established by the operator and acceptable to the Authority, and which shall not be less restrictive than the following:
- (1) No alcohol shall be consumed less than 8 hours prior to the specified reporting time for flight duty or the commencement of standby;
 - (2) The blood alcohol level shall not exceed 0.2 promille at the start of a flight duty period;
 - (3) No alcohol shall be consumed during the flight duty period or whilst on standby.
- (f) The commander shall:
- (1) be responsible for the safety of all crew members, passengers and cargo on board, as soon as he/she arrives on board, until he leaves the aeroplane at the end of the flight;
 - (2) be responsible for the operation and safety of the aeroplane from the moment the aeroplane is first ready to move for the purpose of taxiing prior to take-off until the moment it finally comes to rest at the end of the flight and the engine(s) used as primary propulsion units are shut down;
 - (3) have authority to give all commands he/she deems necessary for the purpose of securing



the safety of the aeroplane and of persons or property carried therein;

- (4) have authority to disembark any person, or any part of the cargo, which, in his/her opinion, may represent a potential hazard to the safety of the aeroplane or its occupants;
 - (5) not allow a person to be carried in the aeroplane who appears to be under the influence of alcohol or drugs to the extent that the safety of the aeroplane or its occupants is likely to be endangered;
 - (6) have the right to refuse transportation of inadmissible passengers, deportees or persons in custody if their carriage poses any risk to the safety of the aeroplane or its occupants;
 - (7) ensure that all passengers are briefed on the location of emergency exits and the location and use of relevant safety and emergency equipment;
 - (8) ensure that all operational procedures and check lists are complied with in detail in accordance with the Operations Manual.
 - (9) observe sterile crew compartment procedures and not permit any crew member to perform any activity during take-off, initial climb, final approach and landing except those duties required for the safe operation of the aeroplane (See also AC to OPS 1.085(f)(9));
 - (10) not permit;
 - (i) a flight data recorder to be disabled, switched off or erased during flight nor permit recorded data to be erased after flight in the event of an accident or an incident subject to mandatory reporting;
 - (ii) a cockpit voice recorder to be disabled or switched off during flight nor permit recorded data to be manually erased during or after flight in the event of an accident or an incident subject to mandatory reporting;
 - (11) decide whether or not to accept an aeroplane with unserviceabilities allowed by the CDL or MEL;
 - (12) be responsible for reporting all known or suspected defects in the aeroplane, to the operator, at the termination of the flight; and
 - (13) ensure that the pre-flight inspection has been carried out.
- (g) The commander or the pilot to whom conduct of the flight has been delegated shall, in an emergency situation that requires immediate decision and action, take any action he/she considers necessary under the circumstances. In such cases he/she may deviate from rules, operational procedures and methods in the interest of safety.
- (h) The commander shall be responsible for ensuring that a flight;
- (1) is not commenced if any flight crew member is incapacitated from performing duties by any cause such as injury, sickness, fatigue, the effects of alcohol or drugs; and
 - (2) is not continued beyond the nearest suitable airport when flight crew members' capacity to perform functions is significantly reduced by impairment of faculties from causes such



as fatigue, sickness, lack of oxygen.

OPS 1.090 Authority of the Commander

The operator shall take all reasonable measures to ensure that all persons carried in the aeroplane obey all lawful commands given by the commander for the purpose of securing the safety of the aeroplane and of persons or property carried therein.

OPS 1.095 Authority to Taxi an Aeroplane

- (a) The operator shall take all reasonable steps to ensure that an aeroplane in his charge is not taxied on the movement area of an aerodrome by a person other than a flight crew member, unless that person, seated at the controls:
- (1) has been duly authorised by the operator or a designated agent and is competent to;
 - (i) taxi the aeroplane;
 - (ii) use the radio telephone; and
 - (2) has received instruction in respect of aerodrome layout, routes, signs, marking, lights, air traffic control signals and instructions, phraseology and procedures, and is able to conform to the operational standards required for safe aeroplane movement at the aerodrome.

OPS 1.100 Admission to Flight Deck

- (a) The operator must ensure that no person, other than a flight crew member assigned to a flight, is admitted to, or carried in, the flight deck unless that person is:
- (1) an operating crew member;
 - (2) a representative of the Authority responsible for certification, licensing or inspection if this is required for the performance of his/her official duties; or
 - (3) permitted by, and carried in accordance with instructions contained in the Operations Manual.
- (b) The commander shall ensure that:
- (1) in the interests of safety, admission to the flight deck does not cause distraction and/or interfere with the flight's operation; and
 - (2) all persons carried on the flight deck are made familiar with the relevant safety procedures.
- (c) The final decision regarding the admission to the flight deck shall be the responsibility of the commander.

OPS 1.105 Unauthorised Carriage

The operator shall take all reasonable measures to ensure that no person secretes himself/herself or secretes cargo on board an aeroplane.

**OPS 1.110 Portable Electronic Devices**

The operator shall not permit any person to use, and take all reasonable measures to ensure that no person does use, on board an aeroplane, a portable electronic device that can adversely affect the performance of the aeroplane's systems and equipment.

OPS 1.115 Alcohol and Drugs

The operator shall not permit any person to enter or be in, and take all reasonable measures to ensure that no person enters or is in, an aeroplane when under the influence of alcohol or drugs to the extent that the safety of the aeroplane or its occupants is likely to be endangered.

OPS 1.120 Endangering Safety

- (a) The operator shall take all reasonable measures to ensure that no person recklessly or negligently acts or omits to act:
- (1) so as to endanger an aeroplane or person therein;
 - (2) so as to cause or permit an aeroplane to endanger any person or property.

OPS 1.125 Documents to be Carried

(See Appendix 1 to OPS 1.125)

(See AC OPS 1.125)

- (a) The operator shall ensure that the following are carried on each flight:
- (1) The Certificate of Registration;
 - (2) The Certificate of Airworthiness;
 - (3) The original or a copy of the Noise Certificate (if applicable), including an English translation, where one has been provided by the Authority responsible for issuing the noise certificate;
 - (4) The original or a certified true copy of the Air Operator Certificate including the operations specifications relevant to the aeroplane type, issued in conjunction with the certificate;
 - (5) The Aircraft Radio Licence;
 - (6) The original or a copy of the Insurance Certificate(s), which cover the aircraft, passengers and third party liability clauses.
- (b) Each flight crew member shall, on each flight, carry a valid flight crew licence with appropriate rating(s) for the purpose of the flight.

OPS 1.130 Manuals to be Carried

(See AMC OPS 1.130)

The operator shall ensure that:



- (a) The current parts of the Operations Manual relevant to the duties of the crew are carried on each flight;
- (b) Those parts of the Operations Manual which are required for the conduct of a flight are easily accessible to the crew on board the aeroplane; and
- (c) The current Aeroplane Flight Manual is carried in the aeroplane unless the Authority has accepted that the Operations Manual prescribed in Part B of Appendix 1 to OPS 1.1045, contains relevant information for that aeroplane.

OPS 1.135 Additional Information and Forms to be Carried

- (a) The operator shall ensure that, in addition to the documents and manuals prescribed in OPS 1.125 and OPS 1.130, the following information and forms, relevant to the type and area of operation, are carried on each flight:
 - (1) Operational Flight Plan containing at least the information required in OPS 1.1060;
 - (2) Aeroplane Technical Log containing at least the information required in the operator's technical log system;
 - (3) Details of the filed ATS flight plan;
 - (4) Appropriate NOTAM/AIS briefing documentation;
 - (5) Appropriate meteorological information;
 - (6) Mass and balance documentation as specified in Subpart J;
 - (7) Notification of special categories of passenger such as security personnel, if not considered as crew, handicapped persons, inadmissible passengers, deportees and persons in custody;
 - (8) Notification of special loads including dangerous goods including written information to the commander as prescribed in OPS 1.1215(c);
 - (9) Current maps and charts and associated documents as prescribed in OPS 1.290(b)(7);
 - (10) Any other documentation which may be required by the States concerned with this flight, such as cargo manifest, passenger manifest, certificates etc.; and
 - (11) Forms to comply with the reporting requirements of the Authority and the operator.
- (b) The Authority may permit the information detailed in sub-paragraph (a) above, or parts thereof, to be presented in a form other than on printed paper. An acceptable standard of accessibility, usability and reliability must be assured.

OPS 1.140 Information Retained on the Ground

- (a) The operator shall ensure that:
 - (1) At least for the duration of each flight or series of flights;



- (i) information relevant to the flight and appropriate for the type of operation is preserved on the ground; and
 - (ii) the information is retained until it has been duplicated at the place at which it will be stored in accordance with OPS 1.1065; or, if this is impracticable,
 - (iii) the same information is carried in a fireproof container in the aeroplane.
- (b) The information referred to in subparagraph (a) above includes:
- (1) a copy of the operational flight plan where appropriate;
 - (2) copies of the relevant part(s) of the Aeroplane Technical Log;
 - (3) route-specific NOTAM documentation if specifically edited by the operator;
 - (4) mass and balance documentation if required (OPS 1.625 refers); and
 - (5) special loads notification.

OPS 1.145 Power to Inspect

The operator shall ensure that any person authorised by the Authority is permitted at any time to board and fly in any aeroplane operated in accordance with an AOC issued by that Authority and to enter and remain on the flight deck; provided that the commander may refuse access to the flight deck if, in his opinion, the safety of the aeroplane would thereby be endangered.

OPS 1.150 Production of Documentation and Records

- (a) The operator shall:
- (1) Give any person authorised by the Authority access to any documents and records which are related to flight operations or maintenance; and
 - (2) Produce all such documents and records, when requested to do so by the Authority, within a reasonable period of time.
- (b) The commander shall, within a reasonable time of being requested to do so by a person authorised by an Authority, produce to that person the documentation required to be carried on board.

OPS 1.155 Preservation of Documentation

- (a) The operator shall ensure that:
- (1) Any original documentation, or copies thereof, that he is required to preserve is preserved for the required retention period even if he ceases to be the operator of the aeroplane; and
 - (2) Where a crew member, in respect of whom the operator has kept flight duty, duty and rest period records becomes a crew member for another operator, that record is made available to the new operator.

**OPS 1.160 Preservation, Production and Use of Flight Recorder Recordings**

(See AC OPS 1.160(a)(1) & (2))

(a) *Preservation of recordings*

- (1) Flight recorders shall not be switched off during flight time.
- (2) To preserve flight recorder records, flight recorders shall be deactivated upon completion of flight time following an accident or incident subject to mandatory reporting. The flight recorders shall not be reactivated before their disposition as determined in accordance with CAR ACC.
- (3) Following an accident, the operator of an aeroplane on which a flight recorder is carried shall, to the extent possible, preserve the original recorded data pertaining to that accident, as retained by the recorder for a period of 60 days. The flight recorders shall not be reactivated before their disposition as determined by the investigating authority.
- (4) Unless prior permission has been granted by the Authority, following an incident that is subject to mandatory reporting, the operator of an aeroplane on which a flight recorder is carried shall, to the extent possible, preserve the original recorded data pertaining to that incident, as retained by the recorder for a period of 60 days. The flight recorders shall not be reactivated before their disposition as determined by the investigating authority.
- (5) Additionally, when the Authority so directs, the operator of an aeroplane on which a flight recorder is carried shall preserve the original recorded data for a period of 60 days unless otherwise directed by the investigating authority.
- (6) When a flight data recorder is required to be carried aboard an aeroplane, the operator of that aeroplane shall:
 - (i) save the recordings for the period of operating time as required by OPS 1.710, to 1.725 inclusive except that, for the purpose of testing and maintaining flight data recorders, up to one hour of the oldest recorded material at the time of testing may be erased; and
 - (ii) keep a document which presents the information necessary to retrieve and convert the stored data into engineering units. The documentation must be updated at regular intervals and shall contain;
 - (A) flight data recorder parameter allocations;
 - (B) conversion equations;
 - (C) periodic calibration records; and
 - (D) other serviceability/maintenance information.

(b) *Production of recordings.* the operator of an aeroplane on which a flight recorder is carried shall, within a reasonable time after being requested to do so by the Authority, produce any recording made by a flight recorder which is available or has been preserved.



(c) *Use of recordings*

- (1) The cockpit voice recorder recordings may not be used for purposes other than for the investigation of an accident or incident subject to mandatory reporting except with the consent of all crew members concerned.
- (2) The flight data recorder recordings may not be used for purposes other than for the investigation of an accident or incident subject to mandatory reporting except when such records are:
 - (i) used by the operator for airworthiness or maintenance purposes only; or
 - (ii) de-identified; or
 - (iii) disclosed under secure procedures.

OPS 1.161 Use of Flight Recorder Recordings by Authority

(See Appendix 1 to OPS 1.161)

- (a) The Authority shall not allow the use of recordings or transcripts of CVR, CARS, Class A AIR and Class A AIRS for purposes other than the investigation of an accident or incident in accordance with CAR ACC except where the recordings or transcripts:
 - (1) are related to a safety-related event identified in the context of a safety management system; are restricted to the relevant portions of a de-identified transcript of the recording; and are subject to the protections accorded by Safety Management Systems;
 - (2) are sought for use in criminal proceedings not related to an event involving an accident or incident investigation and are subject to the protections accorded by Safety Management Systems; or
 - (3) are used for inspections of flight recorder systems.

Note: When an investigation under CAR ACC, or under ICAO Annex 13 by another State, is instituted, investigation records are subject to the protections accorded by CAR ACC.

- (b) The Authority shall not allow the use of recordings or transcripts of FDR, ADRS as well as Class B and Class C AIR and AIRS for purposes other than the investigation of an accident or incident in accordance with CAR ACC, except where the recordings or transcripts are subject to the protections accorded by Safety Management Systems; and:
 - (1) are used by the operator for airworthiness or maintenance purposes;
 - (2) are used by the operator in the operation of a flight data analysis programme;
 - (3) are sought for use in proceedings not related to an event involving an accident or incident investigation;
 - (4) are de-identified; or
 - (5) are disclosed under secure procedures.

**OPS 1.165 Leasing****(a) Terminology**

Terms used in this paragraph have the following meaning:

- (1) *Dry lease* – Is when the aeroplane is operated under the AOC of the lessee.
- (2) *Wet lease* – Is when the aeroplane is operated under the AOC of the lessor.

(b) Operational control**(c) Leasing of aeroplanes between the operator and any entity****(1) Dry lease-in**

- (i) The operator shall not dry lease-in an aeroplane from an entity unless approved by the Authority. Any conditions which are part of this approval must be included in the lease agreement.
- (ii) The operator shall ensure that, with regard to aeroplanes that are dry leased-in, any differences from the requirements prescribed in Subparts K, L and S, and/or OPS 1.005(b), are notified to and are acceptable to the Authority.

(2) Wet lease-in

(See AC OPS 1.165(c)(2))

- (i) The operator shall not wet lease-in an aeroplane from an entity without the approval of the Authority.
- (ii) The operator shall ensure that, with regard to aeroplanes that are wet leased-in:
 - (A) the safety standards of the lessor with respect to maintenance and operation are equivalent to OPS 1 and CAR Part 145;
 - (B) the lessor is the operator holding an AOC issued by a State which is a signatory to the Chicago Convention;
 - (C) the aeroplane has a standard Certificate of Airworthiness issued in accordance with ICAO Annex 8; and
 - (D) any requirement made applicable by the lessee's Authority is complied with.

(3) Dry lease-out

- (i) The operator may dry lease-out an aeroplane for the purpose of commercial air transportation to any operator of a State which is signatory to the Chicago Convention provided that the following conditions are met:
 - (A) The Authority has exempted the operator from the relevant provisions of OPS 1 and, after the foreign regulatory authority has accepted responsibility in writing for surveillance of the maintenance and operation of the aeroplane(s), has removed the aeroplane from its AOC; and



- (B) The aeroplane is maintained according to an approved maintenance programme.
- (4) *Wet lease-out.* the operator providing an aeroplane and complete crew to another entity and retaining all the functions and responsibilities prescribed in Subpart C, shall remain the operator of the aeroplane.

OPS 1.170 Aeroplane operated under an Article 83 *bis* agreement

- (a) An aeroplane, when operating under an Article 83 *bis* agreement entered into between the State of Registry and the State of the Operator, shall carry a certified true copy of the agreement summary, in either an electronic or hard copy format. When the summary is issued in a language other than English, an English translation shall be included.
- (b) The agreement summary of an Article 83 *bis* agreement shall be accessible to a civil aviation safety inspector to determine which functions and duties are transferred under the agreement by the State of Registry to the State of the Operator, when conducting surveillance activities such as ramp checks.
- (c) The agreement summary shall be transmitted to ICAO together with the Article 83 *bis* Agreement for registration with the ICAO Council by the State of Registry or the State of the Operator.

Note: The agreement summary transmitted with the Article 83 bis agreement registered with the ICAO Council contains the list of all aircraft affected by the agreement. However, the certified true copy to be carried on board will need to list only the specific aircraft carrying the copy.

- (d) The agreement summary should contain the information in ICAO 6, Part I, Appendix 10 for the specific aircraft and should follow the layout of Appendix 10, paragraph 2.



Appendix 1 to OPS 1.005(a)
Operations of Performance Class B Aeroplanes
(See AC to Appendix 1 to OPS 1.005(a))

(a) *Terminology*

- (1) A to A operations – Take-off and landing are made at the same place.
- (2) A to B operations – Take-off and landing are made at different places.
- (3) Night – The hours between the end of evening civil twilight and the beginning of morning civil twilight or such other period between sunset and sunrise, as may be prescribed by the appropriate authority. (See AC to Appendix 1 to OPS 1.005(a))

(b) Operations, to which this Appendix is applicable, may be conducted in accordance with the following alleviations.

(1) *OPS 1.035 Quality System:*

In the case of a very small operator, the post of Quality Manager may be held by a nominated postholder if external auditors are used. This applies also where the Accountable Manager is holding one or several of the nominated posts.

(2) *OPS 1.037 Safety Management System:*

(See AC to Appendix 1 to OPS 1.005 (a))

(3) *OPS 1.075 Methods of carriage of persons:*

Not required for VFR operations of single-engine aeroplanes.

(4) *OPS 1.100 Admission to the flight deck:*

- (i) The operator must establish rules for the carriage of passengers in a pilot seat.
- (ii) The commander must ensure that;
 - (A) carriage of passengers in a pilot seat does not cause distraction and/or interference with the operation of the flight; and
 - (B) the passenger occupying a pilot seat is made familiar with the relevant restrictions and safety procedures.

(5) *OPS 1.105 Unauthorised Carriage:*

Not required for VFR operations of single-engine aeroplanes.

(6) *OPS 1.135 Additional information and forms to be carried:*

- (i) For A to A VFR operations of single-engine aeroplanes by day, the following documents need not be carried:
 - (A) Operational Flight Plan;



- (B) Aeroplane Technical Log;
 - (C) NOTAM/AIS briefing documentation;
 - (D) Meteorological Information;
 - (E) Notification of special categories of passengers etc.; and
 - (F) Notification of special loads including dangerous goods ... etc.
- (ii) For A to B VFR operations of single-engine aeroplanes by day. Notification of special categories of passengers as described in OPS 1.135 (a)(7) does not need to be carried.
- (iii) For A to B VFR operations by day, the Operational Flight Plan may be in a simplified form and must meet the needs of the type of operation.
- (7) *OPS 1.215 Use of Air Traffic Services:*
- For VFR operations of single-engine aeroplanes by day, non-mandatory contact with ATS shall be maintained to the extent appropriate to the nature of the operation. Search and rescue services must be ensured in accordance with OPS 1.300.
- (8) *OPS 1.225 Aerodrome Operating Minima:*
- For VFR operations, the standard VFR operating minima will normally cover this requirement. Where necessary, the operator shall specify additional requirements taking into account such factors as radio coverage, terrain, nature of sites for take-off and landing, flight conditions and ATS capacity
- (9) *OPS 1.235 Noise abatement procedures:*
- Not applicable to VFR operations of single-engine aeroplanes.
- (10) *OPS 1.240 Routes and Areas of Operation:*
- Subparagraph (a)(1) is not applicable to A to A VFR operations of single-engine aeroplanes by day.
- (11) *OPS 1.250 Establishment of minimum flight altitudes:*
- For VFR operations by day, this requirement is applicable as follows. the operator shall ensure that operations are only conducted along such routes or within such areas for which a safe terrain clearance can be maintained and shall take account of such factors as temperature, terrain, unfavourable meteorological conditions (e.g. severe turbulence and descending air currents, corrections for temperature and pressure variations from standard values).
- (12) *OPS 1.255 Fuel Policy:*
- (i) For A to A Flights - the operator shall specify the minimum fuel contents at which a flight must end. This minimum, final reserve, fuel must not be less than the amount needed to fly for a period of 45 minutes.



- (ii) For A to B Flights – the operator shall ensure that the pre-flight calculation of usable fuel required for a flight includes;
- (A) Taxi fuel - Fuel consumed before take-off, if significant; and
 - (B) Trip fuel (Fuel to reach the destination); and
 - (C) Reserve fuel -
 - (1) Contingency fuel - Fuel that is not less than 5% of the planned trip fuel or, in the event of in-flight replanning, 5% of the trip fuel for the remainder of the flight; and
 - (2) Final reserve fuel - Fuel to fly for an additional period of 45 minutes (piston engines) or 30 minutes (turbine engines); and
 - (D) Alternate fuel - Fuel to reach the destination alternate via the destination, if a destination alternate is required
 - (E) Extra fuel – Fuel that the commander may require in addition to that required under subparagraphs (A) – (D) above.
- (13) *OPS 1.265 Carriage of inadmissible passengers, deportees or persons in custody:*
- For VFR operations of single-engine aeroplanes and where it is not intended to carry inadmissible passengers, deportees or persons in custody, the operator is not required to establish procedures for the carriage of such passengers.
- (14) *OPS 1.280 Passenger Seating:*
- Not Applicable to VFR operations of single-engine aeroplanes.
- (15) *OPS 1.285 Passenger Briefing:*
- Demonstration and briefing shall be given as appropriate to the kind of operations. In single-pilot operations, the pilot may not be allocated tasks distracting him/her from his/her flying duties.
- (16) *OPS 1.290 Flight Preparation:*
- (i) Operational Flight Plan for A to A operations - Not Required.
 - (ii) A to B operations under VFR by day - the operator shall ensure that a simplified form of an operational flight plan which is relevant to the type of operation is completed for each flight.
- (17) *OPS 1.295 Selection of aerodromes:*
- Not applicable to VFR operations. The necessary instructions for the use of aerodromes and sites for take-off and landing are to be issued with reference to OPS 1.220.



(18) *OPS 1.310 Crew members at stations:*

For VFR operations, instructions on this matter are required only where two pilot operations are conducted.

(19) *OPS 1.375 In-flight fuel management:*

OPS 1.375(a) is not required to be applied to VFR operations of single-engine aeroplanes by day.

(20) *OPS 1.405 Commencement and continuation of approach:*

Not applicable to VFR operations.

(21) *OPS 1.410 Operating procedures - threshold crossing height:*

Not applicable to VFR operations.

(22) *OPS 1.430 to 1.460, including appendices:*

Not applicable to VFR operations.

(23) *OPS 1.530 Take-off:*

(i) Subparagraph (a) applies with the following addition. The Authority may, on a case by case basis, accept other performance data produced by the operator and based on demonstration and/or documented experience. Subparagraphs (b) and (c) apply with the following addition. Where the requirements of this paragraph cannot be complied with due to physical limitations relating to extending the runway and there is a clear public interest and necessity for the operation, the Authority may accept, on a case by case basis, other performance, not conflicting with the Aeroplane Flight Manual, data relating to special procedures, produced by the operator based on demonstration and/or documented experience.

(ii) The operator wishing to conduct operations according to subparagraph (i) must have the prior approval of the Authority issuing the AOC. Such an approval will:

(A) Specify the type of aeroplane;

(B) Specify the type of operation;

(C) Specify the aerodrome(s) and runways concerned;

(D) Restrict the take-off to be conducted under VMC;

(E) Specify the crew qualification, and

(F) Be limited to aeroplanes where the type certificate was first issued before 01 January 2005.

(iii) The operation must be accepted by the State in which the aerodrome is located.

(24) *OPS 1.535 Take-off Obstacle Clearance – Multi-Engine aeroplanes:*



- (i) Sub-paragraphs (a)(3), (a)(4), (a)(5), (b)(2), (c)(1), (c)(2) and the Appendix are not applicable to VFR operations by day.
 - (ii) For IFR or VFR operations by day, sub-paragraphs (b) and (c) apply with the following variations.
 - (A) Visual course guidance is considered available when the flight visibility is 1500 m or more
 - (B) The maximum corridor width required is 300 m when flight visibility is 1500 m or more.
- (25) *OPS 1.545 Landing Destination and Alternate Aerodromes:*
- (i) The paragraph applies with the following addition. Where the requirements of this paragraph cannot be complied with due to physical limitations relating to extending the runway and there is a clear public interest and operational necessity for the operation, the Authority may accept, on a case by case basis, other performance data, not conflicting with the Aeroplane Flight Manual relating to special procedures, produced by the operator based on demonstration and/or documented experience.
 - (ii) The operator wishing to conduct operations according to subparagraph (I) must have prior approval of the Authority issuing the AOC. Such an approval will:
 - (A) Specify the type of aeroplane;
 - (B) Specify the type of operation;
 - (C) Specify the aerodrome(s) and runways concerned;
 - (D) Restrict the final approach and landing to be conducted under VMC;
 - (E) Specify the crew qualification, and
 - (F) Be limited to aeroplanes where the type certificate was first issued before 01 January 2005.
 - (iii) The operation must be accepted by the state in which the aerodrome is located.
- (26) *OPS 1.550 Landing Dry Runways:*
- (i) The paragraph applies with the following addition. Where the requirements of this paragraph cannot be complied with due to physical limitations relating to extending the runway and there is a clear public interest and operational necessity for the operation, the Authority may accept, on a case by case basis, other performance data, not conflicting with the Aeroplane Flight Manual, relating to special procedures, produced by the operator based on demonstration and/or documented experience.
 - (ii) The operator wishing to conduct operations according to subparagraph (i) must



have prior approval of the Authority issuing the AOC. Such an approval will:

- (A) Specify the type of aeroplane;
- (B) Specify the type of operation;
- (C) Specify the aerodrome(s) and runways concerned;
- (D) Restrict the final approach and landing to be conducted under VMC;
- (E) Specify the crew qualification; and
- (F) Be limited to aeroplanes where the first type certificate was issued before 01 January 2005.

(iii) The operation must be accepted by the state in which the aerodrome is located.

(27) *(Reserved)*

(28) *OPS 1.650 Day VFR operations:*

Paragraph 1.650 is applicable with the following addition. Single-engine aeroplanes, first issued with an individual certificate of airworthiness before 22 May 1995, may be exempted from the requirements of subparagraphs (f), (g), (h) and (i) by the Authority if the fulfilment would require retrofitting.

(29) *Subpart M - Maintenance Management Exposition*

The Continuing Airworthiness Management Exposition may be adapted to the operation to be conducted.

(30) *Subpart M - Operator's technical log system:*

(See AC to Appendix 1 to OPS 1.1005(a))

The Authority may approve an abbreviated form of Technical Log System, relevant to the type of operation conducted.

(31) *OPS 1.940 Composition of Flight Crew:*

Subparagraphs (a)(2), (a)(4), and (b) are not applicable to VFR operations by day, except that (a)(4) must be applied in full where 2 pilots are required by OPS 1.

(32) *OPS 1.945 Conversion training and checking:*

- (i) Subparagraph (a)(7) - Line flying under supervision (LIFUS) may be performed on any aeroplane within the applicable class. The amount of LIFUS required is dependent on the complexity of the operations to be performed.
- (ii) Subparagraph (a)(8) is not required.



(33) *OPS 1.955 Nomination as commander:*

Subparagraph (b) applies as follows.

The Authority may accept an abbreviated command course relevant to the type of operation conducted.

(34) *OPS 1.960 Commanders holding a Commercial Pilot Licence*

Subparagraph (a)(1)(i) is not applicable to VFR operations by day.

(35) *OPS 1.965 Recurrent training and checking:*

(i) Subparagraph (a)(1) shall be applied as follows for VFR operations by day. All training and checking shall be relevant to the type of operation and class of aeroplane on which the flight crew member operates with due account taken of any specialised equipment used.

(ii) Subparagraph (a)(3)(ii) applies as follows. Training in the aeroplane may be conducted by a Class Rating Examiner (CRE), a Flight Examiner (FE) or a Type Rating Examiner (TRE).

(iii) Subparagraph (a)(4)(i) applies as follows. Operator proficiency check may be conducted by a Type Rating Examiner (TRE), Class Rating Examiner (CRE) or by a suitably qualified commander nominated by the operator and acceptable to the Authority, trained in CRM concepts and the assessment of CRM skills.

(iv) Sub-paragraph (b)(2) shall be applicable as follows for VFR operations by day. - In those cases where the operations are conducted during seasons not longer than 8 consecutive months, 1 operator proficiency check is sufficient. This proficiency check must be undertaken before commencing operations.

(36) *OPS 1.968 Pilot qualification for either pilot's seat:*

Appendix 1 is not applicable to VFR operations of single-engine aeroplanes by day.

(37) *OPS 1.975 Route and Aerodrome Competence:*

(i) For VFR operations by day, sub-paragraphs (b), (c) and (d) are not applicable, except that the operator shall ensure that in the cases where a special approval by the state of the aerodrome is required, the associated requirements are observed.

(ii) For IFR operations or VFR operations by night, as an alternative to sub-paragraphs (b) - (d), route and aerodrome competence may be revalidated as follows.

(A) Except for operations to the most demanding aerodromes, by completion of at least 10 sectors within the area of operation during the preceding 12 months in addition to any required self-briefing.

(B) Operations to the most demanding aerodromes may be performed only if



- (1) The commander has been qualified at the aerodrome within the preceding 36 months; by a visit as an operating flight crew member or as an observer.
 - (2) The approach is performed in VMC from the applicable minimum sector altitude; and
 - (3) An adequate self-briefing has been made prior to the flight
- (38) *OPS 1.980 More than one type or variant:*
- (i) Not applicable if operations are limited to single-pilot classes of piston engine aeroplanes under VFR by day.
 - (ii) For IFR and VFR Night Operations, the requirement in Appendix 1 to OPS 1.980, subparagraph (d)(2)(i) for 500 hours in the relevant crew position before exercising the privileges of 2 licence endorsements, is reduced to 100 hours or sectors if one of the endorsements is related to a class. A check flight must be completed before the pilot is released for duties as commander
- (39) *OPS 1.981 Operation of helicopters and aeroplanes:*
- Subparagraph (a)(1) is not applicable if operations are limited to single-pilot classes of piston engine aeroplanes .
- (40) *OPS 1.1045 Operations Manual – structure and contents:*
- See AMC OPS 1.1045
- (41) *OPS 1.1060 Operational flight plan:*
- Not required for A to A VFR/Day operations. For A to B VFR/Day operations the requirement is applicable but the flight plan may be in a simplified form relevant to the kind of operations conducted. (cf. OPS 1.135).
- (42) *OPS 1.1070 – Maintenance Exposition:*
- The Exposition may be adapted to the operation to be conducted.
- See AC to Appendix 1 to OPS 1.005(a)
- (43) *OPS 1.1071 Aeroplane technical log:*
- Applicable as indicated for Subpart M - Operator's technical log system
- (44) *Subpart R - Transport of dangerous goods by air:*
- See AC to Appendix 1 to OPS 1.005(a)
- (45) *OPS 1.1235 Security requirements:*



See AC to Appendix 1 to OPS 1.005(a)

(46) *OPS 1.1240 Training programmes:*

The training programmes shall be adapted to the kind of operations performed. A self-study training programme may be acceptable for VFR operations.

(47) *OPS 1.1250 Aeroplane search procedure checklist:*

Not applicable for VFR operations by day.



Appendix 1 to OPS 1.037
Framework for a Safety Management System (SMS)
(See OPS 1.037)

This Appendix specifies the framework for the implementation and maintenance of an SMS. The framework comprises four components and twelve elements as the minimum requirements for SMS implementation:

1. Safety policy and objectives

1.1 Management commitment

1.1.1 The operator shall define its safety policy in accordance with international and national requirements. The safety policy shall:

- (a) reflect organisational commitment regarding safety, including the promotion of a positive safety culture;
- (b) include a clear statement about the provision of the necessary resources for the implementation of the safety policy;
- (c) include safety reporting procedures;
- (d) clearly indicate which types of behaviours are unacceptable related to the operator's aviation activities and include the circumstances under which disciplinary action would not apply;
- (e) be signed by the accountable manager of the organisation;
- (f) be communicated, with visible endorsement, throughout the organisation; and
- (g) be periodically reviewed to ensure it remains relevant and appropriate to the operator.

1.1.2 Taking due account of its safety policy, the operator shall define safety objectives. The safety objectives shall:

- (a) form the basis for safety performance monitoring and measurement;
- (b) reflect the operator's commitment to maintain or continuously improve the overall effectiveness of the SMS;
- (c) be communicated throughout the organisation; and
- (d) be periodically reviewed to ensure they remain relevant and appropriate to the operator.

1.2 Safety accountability and responsibilities

The operator shall:

- (a) identify the accountable executive who, irrespective of other functions, is accountable on behalf of the organisation for the implementation and maintenance of an effective SMS;



- (b) clearly define lines of safety accountability throughout the organisation, including a direct accountability for safety on the part of senior management;
- (c) identify the responsibilities of all members of management, irrespective of other functions, as well as of employees, with respect to the safety performance of the organisation;
- (d) document and communicate safety accountability, responsibilities and authorities throughout the organisation; and
- (e) define the levels of management with authority to make decisions regarding safety risk tolerability.

1.3 Appointment of key safety personnel

The operator shall appoint a safety manager who is responsible for the implementation and maintenance of the SMS.

Note 1: Depending on the size of the operator and the complexity of its services, the responsibilities for the implementation and maintenance of the SMS may be assigned to one or more persons, fulfilling the role of safety manager, as their sole function or combined with other duties, provided these do not result in any conflicts of interest.

Note 2: The person(s) with responsibilities for fulfilling the role of safety manager shall have received training, acceptable to the Authority, on safety management systems (SMS) and have a detailed knowledge of the safety management system within the approved organisation.

1.4 Coordination of emergency response planning

The operator required to establish and maintain an emergency response plan for accidents and incidents in aircraft operations and other aviation emergencies shall ensure that the emergency response plan is properly coordinated with the emergency response plans of those organisations it must interface with during the provision of its services.

1.5 SMS documentation

1.5.1 The operator shall develop and maintain an SMS manual that describes its:

- (a) safety policy and objectives;
- (b) SMS requirements;
- (c) SMS processes and procedures; and
- (d) accountability, responsibilities and authorities for SMS processes and procedures.

1.5.2 The operator shall develop and maintain SMS operational records as part of its SMS documentation.

Note Depending on the size of the operator and the complexity of its aviation services, the SMS manual and SMS operational records may be in the form of stand-alone documents or may



be integrated with other organisational documents (or documentation) maintained by the operator.

2. Safety risk management

2.1 Hazard identification

2.1.1 The operator shall develop and maintain a process to identify hazards associated with its services.

2.1.2 Hazard identification shall be based on a combination of reactive and proactive methods.

2.2 Safety risk assessment and mitigation

The operator shall develop and maintain a process that ensures analysis, assessment and control of the safety risks associated with identified hazards.

Note: The process may include predictive methods of safety data analysis.

3. Safety assurance

3.1 Safety performance monitoring and measurement

3.1.1 The operator shall develop and maintain the means to verify the safety performance of the organisation and to validate the effectiveness of safety risk controls.

Note: An internal audit process is one means to monitor compliance with safety regulations, the foundation upon which SMS is built, and assess the effectiveness of these safety risk controls and the SMS.

3.1.2 The operator's safety performance shall be verified in reference to the safety performance indicators and safety performance targets of the SMS in support of the organisation's safety objectives.

3.2 The management of change

The operator shall develop and maintain a process to identify changes which may affect the level of safety risk associated with its services and to identify and manage the safety risks that may arise from those changes.

3.3 Continuous improvement of the SMS

The operator shall monitor and assess its SMS processes to maintain or continuously improve the overall effectiveness of the SMS.

4. Safety promotion

4.1 Training and education

4.1.1 The operator shall develop and maintain a safety training programme that ensures that personnel are trained and competent to perform their SMS duties.

4.1.2 The scope of the safety training programme shall be appropriate to each individual's involvement in the SMS.



4.2 Safety communication

The operator shall develop and maintain a formal means for safety communication that:

- (a) ensures personnel are aware of the SMS to a degree commensurate with their positions;
- (b) conveys safety-critical information;
- (c) explains why particular actions are taken to improve safety; and
- (d) explains why safety procedures are introduced or changed.



Appendix 1 to OPS 1.125
Documents to be Carried
See OPS 1.125

In case of loss or theft of documents specified in OPS 1.125, the operation is allowed to continue until the flight reaches the base or a place where a replacement document can be provided.



Appendix 1 to OPS 1.161

Principles for Protection of Safety Data, Safety Information and Related Sources (See OPS 1.161)

1. General principles

- (a) The Authority shall, through national laws, regulations and policies protecting safety data, safety information and related sources, ensure that:
- (1) a balance is struck between the need for the protection of safety data, safety information and related sources to maintain or improve aviation safety, and the need for the proper administration of justice;
 - (2) safety data, safety information and related sources are protected in accordance with CAR OPS 1 and the Appendix to CAR ACC, Chapter 5, as applicable;
 - (3) the conditions under which safety data, safety information and related sources qualify for protection are specified; and
 - (4) safety data and safety information remain available for the purpose of maintaining or improving aviation safety.

2. Principles of protection

- (a) The Authority shall ensure that safety data or safety information is not used for:
- (1) disciplinary, civil, administrative and criminal proceedings against employees, operational personnel or organizations;
 - (2) disclosure to the public; or
 - (3) any purposes other than maintaining or improving safety;
- unless a principle of exception applies.
- (b) The Authority shall accord protection to safety data, safety information and related sources by ensuring that:
- (1) the protection is specified based on the nature of safety data and safety information;
 - (2) a formal procedure to provide protection to safety data, safety information and related sources is established;
 - (3) safety data and safety information will not be used in a way different from the purposes for which they were collected, unless a principle of exception applies; and
 - (4) to the extent that a principle of exception applies, the use of safety data and safety information in disciplinary, civil, administrative and criminal proceedings will be carried out only under authoritative safeguards.

Note 1: The formal procedure may include that any person seeking disclosure of safety data or safety information will provide the justification for its release.



Note 2: Authoritative safeguards include legal limitations or restrictions such as protective orders, closed proceedings, in-camera review, and de-identification of data for the use or disclosure of safety information in judicial or administrative proceedings.

3. Principles of exception

- (a) Exceptions to the protection of safety data, safety information and related sources shall only be granted when the Authority;
- (1) determines that there are facts and circumstances reasonably indicating that the occurrence may have been caused by an act or omission considered, in accordance with national laws, to be conduct constituting gross negligence, wilful misconduct or criminal activity;
 - (2) after reviewing the safety data or safety information, determines that its release is necessary for the proper administration of justice, and that the benefits of its release outweigh the adverse domestic and international impact such release is likely to have on the future collection and availability of safety data and safety information; or
 - (3) after reviewing the safety data or safety information, determines that its release is necessary for maintaining or improving safety, and that the benefits of its release outweigh the adverse domestic and international impact such release is likely to have on the future collection and availability of safety data and safety information.

Note 1: In administering the decision, the Authority takes into account the consent of the source of the safety data and safety information.

Note 2: Different competent authorities may be designated for different circumstances. The competent authority could include, but is not limited to, judicial authorities or those otherwise entrusted with aviation responsibilities designated in accordance with national law.

4. Public disclosure

- (a) The Authority shall, in the context of requests made for public disclosure, create exceptions from public disclosure to ensure the continued confidentiality of voluntarily supplied safety data and safety information.

Note: Laws, regulations and policies commonly referred to as right-to-know laws (freedom-of-information or open records) allow for public access to information held by the Authority.

- (b) Where disclosure is made in accordance with Section 3 above, the Authority shall ensure that:
- (1) public disclosure of relevant personal information included in the safety data or safety information complies with applicable privacy laws; or
 - (2) public disclosure of the safety data or safety information is made in a de-identified, summarized or aggregate form.

5. Responsibility of the custodian of safety data and safety information

The Authority shall ensure that each safety data collection and processing systems has a designated custodian to apply the protection to safety data and safety information in accordance with applicable provisions of these regulations.



Note: The “custodian” may refer to an individual or organisation.

6. Protection of recorded data

- (a) The Authority shall, through national laws and regulations, provide specific measures of protection regarding the confidentiality and access by the public to ambient workplace recordings.
- (b) The Authority shall, through national laws and regulations, treat ambient workplace recordings required by national laws and regulations as privileged protected data subject to the principles of protection and exception as provided for in these regulations.

Note 1: Ambient workplace recordings required by national laws, for example, cockpit voice recorders (CVRs) or recordings of background communication and the aural environment at air traffic controller work stations, may be perceived as constituting an invasion of privacy for operational personnel that other professions are not exposed to.

Note 2: Provisions on the protection of flight recorder recordings and recordings from air traffic control units during investigations instituted under CAR ACC are contained therein. Provisions on the protection of flight recorder recordings during normal operations are contained in OPS 1.160.

**SUBPART C****OPERATOR CERTIFICATION AND SUPERVISION****OPS 1.175 General Rules for Air Operator Certification**

Note 1: Appendix 1 to this paragraph specifies the contents and conditions of the AOC.

Note 2: Appendix 2 to this paragraph specifies the management and organisation requirements.

- (a) The operator shall not operate an aeroplane for the purpose of commercial air transportation otherwise than under, and in accordance with, the terms and conditions of an Air Operator Certificate (AOC).
- (b) An applicant for an AOC, or variation of an AOC, shall allow the Authority to examine all safety aspects of the proposed operation.
- (c) An applicant for an AOC must;
 - (1) have his principal place of business and, if any, his registered office located in San Marino; (See AMC OPS 1.175(c)(1));
 - (2) satisfy the Authority that he is able to conduct safe operations.
- (d) If the operator has aeroplanes registered in different States, appropriate arrangements shall be made to ensure appropriate safety oversight.
- (e) The operator shall grant the Authority access to his organisation and aeroplanes and shall ensure that, with respect to maintenance, access is granted to any associated maintenance organisation, to determine continued compliance with OPS 1.
- (f) An AOC will be varied, suspended or revoked if the Authority is no longer satisfied that the operator can maintain safe operations.
- (g) The operator must satisfy the Authority that;
 - (1) its organisation and management are suitable and properly matched to the scale and scope of the operation; and
 - (2) procedures for the supervision of operations have been defined.
- (h) The operator must have nominated an Accountable Manager acceptable to the Authority who has corporate authority for ensuring that all operations and maintenance activities can be financed and carried out to the standard required by the Authority. (See AC OPS 1.175(h))
- (i) The operator must have nominated post holders, acceptable to the Authority, who are responsible for the management and supervision of the following areas,
 - (1) Flight operations;
 - (2) Continuing airworthiness;
 - (3) Crew training; and



- (4) Ground operations (See AC OPS 1.175(i))
- (j) A person may hold more than one of the nominated posts if acceptable to the Authority but, for operators who employ 21 or more full time staff, a minimum of two persons are required to cover the four areas of responsibility. (See AC OPS 1.175(j) & (k).)
- (k) For operators who employ 20 or less full time staff, one or more of the nominated posts may be filled by the Accountable Manager if acceptable to the Authority. (See AC OPS 1.175(j) & (k).)
- (l) The operator must ensure that every flight is conducted in accordance with the provisions of the Operations Manual.
- (m) The operator must arrange appropriate ground handling facilities to ensure the safe handling of its flights.
- (n) The operator must ensure that its aeroplanes are equipped and its crews are qualified, as required for the area and type of operation.
- (o) The operator must comply with the continuing airworthiness requirements, in accordance with Subpart M, for all aeroplanes operated under the terms of its AOC.
- (p) The operator must provide the Authority with a copy of the Operations Manual, as specified in Subpart P and all amendments or revisions to it.
- (q) The operator must maintain operational support facilities at the main operating base, appropriate for the area and type of operation.
- (r) The air operator certificate shall authorise the operator to conduct commercial air transport operations in accordance with the operations specifications.
- (s) The air operator shall maintain permanently its ground handling responsibility, when all or part of the functions and tasks related to ground handling services have been contracted to a service provider

Note: Unless otherwise specified, reference to an Air Operator Certificate includes the operations specifications associated with the air operator certificate.

OPS 1.180 Issue, Variation and Continued Validity of an AOC

- (a) The operator will not be granted an AOC, or a variation to an AOC, and that AOC will not remain valid unless:
- (1) aeroplanes operated have a valid Certificate of Airworthiness;
 - (2) the continuing airworthiness system has been approved by the Authority in accordance with Subpart M; and
 - (3) he has satisfied the Authority that he has the ability to:
 - (i) establish and maintain an adequate organisation;
 - (ii) establish and maintain a Quality System in accordance with OPS 1.035,



- (iii) comply with required training programmes;
 - (iv) comply with continuing airworthiness requirements, consistent with the nature and extent of the operations specified, including the relevant items prescribed in OPS 1.175(g) to (o); and
 - (v) comply with OPS 1.175.
- (b) Notwithstanding the provisions of OPS 1.185(e), the operator must notify the Authority as soon as practicable of any changes to the information submitted in accordance with OPS 1.185(a) below.
- (c) If the Authority is not satisfied that the requirements of subparagraph (a) above have been met, the Authority may require the conduct of one or more demonstration flights, operated as if they were commercial air transport flights.
- (d) The Authority shall establish a system for both the certification and the continued surveillance of the operator to ensure that the required standards of operations established in this Subpart are maintained.

OPS 1.185 Administrative Requirements

- (a) The operator shall ensure that the following information is included in the initial application for an AOC, and when applicable, any variation applied for:
- (1) the official name and business name, address and mailing address of the applicant;
 - (2) a description of the proposed operation;
 - (3) a description of the management organisation;
 - (4) the name of the Accountable Manager;
 - (5) the names of major post holders, including those responsible for flight operations, the continuing airworthiness system, crew training and ground operations together with their qualifications and experience; and
 - (6) the Operations Manual.
- (b) In respect of the operator's continuing airworthiness only, the following information must be included in the initial application for an AOC and, when applicable, any variation applied for, and for each aeroplane type to be operated (see AMC OPS 1.185(b)):
- (1) The operator's Maintenance Management Exposition;
 - (2) The operator's aeroplane maintenance programme(s);
 - (3) The Aeroplane Technical Log;
 - (4) Where appropriate, the technical specification(s) of the maintenance contract(s) between the operator and any approved maintenance organisation;
 - (5) The number of aeroplanes.



- (c) The application for an initial issue of an AOC must be submitted at least 90 days before the date of intended operation except that the Operations Manual may be submitted later but not less than 60 days before the date of intended operation.
- (d) The application for the variation of an AOC must be submitted at least 30 days, or as otherwise agreed, before the date of intended operation.
- (e) Other than in exceptional circumstances, the Authority must be given at least 10 days prior notice of a proposed change of a nominated post holder.

OPS 1.190 Use of Other State's Registered Aircraft

- (a) The Authority shall approve the arrangements by which an air operator uses aircraft on the register of another State, particularly for maintenance and crew training.
- (b) The approval can only be issued after review of such arrangements in coordination with the State of Registry.
- (c) Where appropriate, an agreement transferring oversight responsibilities from the State of Registry to the State of the Operator pursuant to Article 83 *bis* to the Convention on International Civil Aviation shall be arranged to preclude any misunderstandings regarding which State is responsible for specific oversight responsibilities.



Appendix 1 to OPS 1.175

Contents and Conditions of the Air Operator Certificate

- (a) The air operator certificate and its associated operations specifications shall define the operations for which the operator is authorised, including specific approvals, conditions and limitations.
- (b) The AOC and its associated model specific operations specifications shall contain the minimum information required in ICAO Annex 6, Part I, Appendix 6, paragraphs 2 and 3 respectively, in a standardised format.
- (c) The air operator certificate shall contain at least the following information;
 - (1) The State of the Operator and the issuing authority;
 - (2) The air operator certificate number;
 - (3) The operator name, trading name (if different) address of the principal place of business;
 - (4) Date of issue and name, signature and title of the authority representative; and
 - (5) The location, in a controlled document carried on board, where the contact details of operational management can be found.
- (d) For each aircraft model in the operator's fleet, identified by aircraft make, model and series, the following information shall be included:
 - (1) issuing authority contact details, operator name and AOC number, date of issue and signature of the authority representative, aircraft model, types and area of operations;
 - (2) Special limitations; and
 - (3) Specific Approvals;
 - (i) Dangerous Goods
 - (ii) Low visibility operations such as LVTO, CAT II/CAT III (including approved minima)
 - (iii) RVSM
 - (iv) EDTO with threshold time and maximum diversion time
 - (v) AR navigation specifications for PBN operations
 - (vi) Continuing airworthiness
 - (vii) EFB
 - (viii) Operational credit operations with advanced aircraft, when used for low visibility operations
 - (ix) Other; such as



- (A) special aerodrome operations (e.g. short take-off and landing operations or land and hold short operations);
- (B) special approach procedures (e.g. steep gradient approach, instrument landing system precision runway monitor approach, localizer-type directional aid precision runway monitor approach, RNP approach);
- (C) single-engine passenger transport at night or in instrument meteorological conditions; and
- (D) operations in areas with special procedures (e.g. NAT HLA and operations in areas using different altimetry units or altimeter setting procedures).
- (E) authorisation to provide cabin crew initial safety training and, if applicable, to issue the attestation provided for in Subpart O, for those operators who provide such training directly or indirectly.



Appendix 2 to OPS 1.175

The Management and Organisation of an AOC Holder

The issue of an air operator certificate by the Authority shall be dependent upon the operator demonstrating an adequate organisation, method of control and supervision of flight operations, training programme as well as ground handling and maintenance arrangements consistent with the nature and extent of the operations specified.

The continued validity of an air operator certificate shall depend upon the operator maintaining these requirements under the supervision of the Authority.

In particular;

(a) General

The operator must have a sound and effective management structure in order to ensure the safe conduct of air operations. Nominated post holders must have managerial competency together with appropriate technical/operational qualifications in aviation.

(b) Nominated post holders

- (1) A description of the functions and the responsibilities of the nominated post holders, including their names, must be contained in the Operations Manual and the Authority must be given notice in writing of any intended or actual change in appointments or functions.
- (2) The operator must make arrangements to ensure continuity of supervision in the absence of nominated post holders.
- (3) Persons nominated as post holders must be contracted to work sufficient hours to fulfil the management functions associated with the scale and scope of the operation.

(c) Adequacy and supervision of staff

- (1) Crew members. the operator must employ sufficient flight and cabin crew for the planned operation, trained and checked in accordance with Subpart N and Subpart O as appropriate.
- (2) Ground Staff
 - (i) The number of ground staff is dependent upon the nature and the scale of operations. Operations and ground handling departments, in particular, must be staffed by trained personnel who have a thorough understanding of their responsibilities within the organisation.
 - (ii) The operator contracting other organisations to provide certain services retains responsibility for the maintenance of proper standards. In such circumstances, a nominated post holder must be given the task of ensuring that any contractor employed meets the required standards.



(3) Supervision

- (i) The number of supervisors to be appointed is dependent upon the structure of the operator and the number of staff employed.
- (ii) The duties and responsibilities of these supervisors must be defined, and any other commitments arranged so that they can discharge their supervisory responsibilities.
- (iii) The supervision of crew members and ground staff must be exercised by individuals possessing experience and personal qualities sufficient to ensure the attainment of the standards specified in the Operations Manual.

(d) Accommodation facilities

- (1) The operator must ensure that working space available at each operating base is sufficient for personnel pertaining to the safety of flight operations. Consideration must be given to the needs of ground staff, those concerned with operational control, the storage and display of essential records, and flight planning by crews.
- (2) Office services must be capable, without delay, of distributing operational instructions and other information to all concerned.

(e) Documentation.

The operator must make arrangements for the production of manuals, amendments and other documentation.

(f) Third Parties

The operator shall develop policies and procedures for third parties that perform work on its behalf.

**SUBPART D****OPERATIONAL PROCEDURES****OPS 1.192 Terminology**

The terms which are listed below are for use within the context of this Subpart

- (a) Extended diversion time operations (EDTO). Any operation by an aeroplane with two or more turbine engines where the diversion time to an en-route alternate aerodrome is greater than the threshold time established by the Authority in OPS 1.245.
- (b) 3% ERA: An en-route alternate aerodrome selected for the purposes of reducing contingency fuel to 3%.
- (c) Equivalent Position: a position that can be established by means of a DME distance, a suitably located NDB or VOR, SRE or PAR fix or any other suitable fix between 3 and 5 miles from threshold that independently establishes the position of the aeroplane.
- (d) Critical phases of flight: Critical phases of flight are the take-off run, the take-off flight path, the final approach, the landing, including the landing roll, and any other phases of flight at the discretion of the commander.
- (e) Separate Runways: Runways at the same aerodrome that are separate landing surfaces. These runways may overlay or cross in such a way that if one of the runways is blocked, it will not prevent the planned type of operations on the other runway. Each runway shall have a separate approach procedure based on a separate navigation aid.
- (f) Dispatch. EDTO planning minima apply until dispatch. Dispatch is when the aircraft first moves under its own power for the purpose of taking off.

OPS 1.195 Operational Control

(See AC OPS 1.195)

- (a) The operator shall:
 - (1) establish and maintain a method of exercising operational control approved by the Authority; and
 - (2) exercise operational control over any flight operated under the terms of his AOC.
- (b) Responsibility for operational control shall be delegated only to the commander and to a flight dispatcher if the operator's approved method of control and supervision of flight operations requires the use of flight dispatcher personnel.
- (c) If an emergency situation which endangers the safety of the aeroplane or persons becomes known first to the flight dispatcher, action by that person shall include, where necessary, notification to the appropriate authorities of the nature of the situation without delay, and requests for assistance if required. In the event of an emergency, a flight dispatcher shall:
 - (1) initiate such procedures as outlined in the Operations Manual while avoiding taking any action that would conflict with ATC procedures; and



- (2) convey safety-related information to the commander that may be necessary for the safe conduct of the flight, including information related to any amendments to the flight plan that become necessary in the course of the flight.

Note: It is equally important that the commander also convey similar information to the flight dispatcher during the course of the flight, particularly in the context of emergency situations.

- (d) If an emergency situation which endangers the safety of the aeroplane or persons necessitates the taking of action which involves a violation of local regulations or procedures, the commander shall notify the appropriate local authority without delay. If required by the State in which the incident occurs, the commander shall submit a report on any such violation to the appropriate authority of such State; in that event, the commander shall also submit a copy of it to the Authority. Such reports shall be submitted as soon as possible and normally within ten days.

OPS 1.197 Aircraft Tracking

(See AMC OPS 1.197)

The operator shall;

- (a) establish an aircraft tracking capability to track aeroplanes throughout its area of operations.
- (b) track the position of an aeroplane through automated reporting at least every 15 minutes for the portion(s) of the in-flight operation(s) under the following conditions:
 - (1) the aeroplane has a maximum certificated take-off mass of over 27000 kg and a seating capacity greater than 19; and
 - (2) where an ATS unit obtains aeroplane position information at greater than 15 minute intervals.
- (c) track the position of an aeroplane through automated reporting at least every 15 minutes for the portion(s) of the in-flight operation(s) that is planned in an oceanic area(s) under the following conditions:
 - (1) the aeroplane has a maximum certificated take-off mass of over 45500 kg and a seating capacity greater than 19; and
 - (2) where an ATS unit obtains aeroplane position information at greater than 15 minute intervals.
- (d) establish procedures in their company operations manual, approved by the Authority, for the retention of aircraft tracking data to assist SAR in determining the last known position of the aircraft.
- (e) Notwithstanding the provisions in (c) and (d) above, the Authority, as the State of the operator may, based on the results of an approved risk assessment process implemented by the operator, allow for variations to automated reporting intervals. The process shall demonstrate how risks to the operation resulting from such variations can be managed and shall include at least the following:
 - (1) capability of the operator's operational control systems and processes, including those for contacting ATS units;



- (2) overall capability of the aeroplane and its systems;
- (3) available means to determine the position of, and communicate with, the aeroplane;
- (4) frequency and duration of gaps in automated reporting;
- (5) human factors consequences resulting from changes to flight crew procedures; and
- (6) specific mitigation measures and contingency procedures.

Note: Refer to Appendix 2 to OPS 1.175(f) for operator responsibilities when using third parties for the conduct of aircraft tracking.

OPS 1.200 Operations Manual

The operator shall provide an Operations Manual in accordance with Subpart P for the use and guidance of operations personnel.

OPS 1.205 Competence of Operations Personnel

(See AC OPS 1.205)

The operator shall ensure that all personnel assigned to, or directly involved in, ground and flight operations are properly instructed, have demonstrated their abilities in their particular duties and are aware of their responsibilities and the relationship of such duties to the operation as a whole.

OPS 1.207 Flight Dispatcher

- (a) When the Authority requires that a flight dispatcher, employed in conjunction with an approved method of control and supervision of flight operations, be licensed, that flight dispatcher shall be licensed in accordance with the provisions of ICAO Annex 1.
- (b) In accepting proof of qualifications other than the option of holding of a flight dispatcher licence, the Authority, in accordance with the approved method of control and supervision of flight operations, shall require that, as a minimum, such persons meet the requirements specified in ICAO Annex 1 for the flight dispatcher licence.
- (c) A flight dispatcher in conjunction with a method of control and supervision of flight operations shall:
 - (1) assist the commander in flight preparation and provide the relevant information;
 - (2) assist the commander in preparing the operational and ATS flight plans, sign when applicable and file the ATS flight plan with the appropriate ATS unit;
 - (3) furnish the commander while in flight, by appropriate means, with information which may be necessary for the safe conduct of the flight; and
 - (4) notify the appropriate ATS unit when the position of the aeroplane cannot be determined by an aircraft tracking capability and attempts to establish communication are unsuccessful.
- (d) A flight dispatcher shall not be assigned to duty unless that person has:
 - (1) satisfactorily completed the operator-specific training course that addresses all the specific components of its approved method of control and supervision of flight operations;



- (2) made, within the preceding 12 months, at least a one way qualification flight in the flight crew compartment of an aeroplane over any area for which that individual is authorised to exercise flight supervision. The flight should include landings at as many aerodromes as practicable;

Note: For the purpose of the qualification flight, the flight dispatcher must be able to monitor the flight crew intercommunication system and radio communications, and be able to observe the actions of the flight crew.

- (3) demonstrated to the operator a knowledge of:
- (i) the contents of the Operations Manual;
 - (ii) the radio equipment in the aeroplanes used; and
 - (iii) the navigation equipment in the aeroplanes used;
- (4) demonstrated to the operator a knowledge of the following details concerning operations for which the officer is responsible and areas in which that individual is authorised to exercise flight supervision:
- (i) the seasonal meteorological conditions and the sources of meteorological information;
 - (ii) the effects of meteorological conditions on radio reception in the aeroplanes used;
 - (iii) the peculiarities and limitations of each navigation system which is used by the operation; and
 - (iv) the aeroplane loading instructions;
- (5) demonstrated to the operator knowledge and skills related to human performance relevant to dispatch duties; and
- (6) demonstrated to the operator the ability to perform the duties specified in OPS 1.195.
- (7) maintained complete familiarization with all features of the operation which are pertinent to such duties, including knowledge and skills related to human performance.
- (e) A flight dispatcher should not be assigned to duty after 12 consecutive months of absence from such duty, unless the provisions of paragraph (d) above are met.

OPS 1.210 Establishment of Procedures

- (a) The operator shall establish procedures and instructions, for each aeroplane type, containing ground staff and crew members' duties for all types of operation on the ground and in flight. (See AMC OPS 1.210(a).)
- (b) The operator shall establish a check-list system to be used by crew members for all phases of operation of the aeroplane under normal, abnormal and emergency conditions as applicable, to ensure that the operating procedures in the Operations Manual are followed. (See AMC OPS 1.210 (b).)



- (c) The operator shall not require a crew member to perform any activities during critical phases of the flight other than those required for the safe operation of the aeroplane. (See OPS 1.192(d) and AC OPS 1.085(f)(9).
- (d) The operator shall provide operations staff and flight crew with an aircraft operating manual, for each aircraft type operated, containing;
 - (1) the normal, abnormal and emergency procedures relating to the operation of the aircraft;
 - (2) details of the aircraft systems and of the checklists to be used.
- (e) The design and utilisation of checklists required in (b) above shall observe Human Factors principles.

OPS 1.215 Use of Air Traffic Services

The operator shall ensure that Air Traffic Services are used for all flights whenever available.

OPS 1.216 In-flight Operational Instructions

The operator shall ensure that his in-flight operational instructions involving a change to the air traffic flight plan shall, when practicable, be coordinated with the appropriate Air Traffic Service unit before transmission to an aeroplane.

OPS 1.220 Authorisation of Aerodromes by the Operator

(See OPS 1.192)

The operator shall only authorise use of aerodromes that are adequate for the type(s) of aeroplane and operation(s) concerned.

OPS 1.225 Aerodrome Operating Minima

- (a) The operator shall specify aerodrome operating minima, established in accordance with OPS 1.430 for each departure, destination or alternate aerodrome authorised to be used in accordance with OPS 1.220. Such minima shall be approved by the Authority and not be lower than any that may be established for such aerodromes by the State of the Aerodrome, except when specifically approved by that State.
- (b) Any increment imposed by the Authority must be added to the minima specified in accordance with sub-paragraph (a) above.
- (c) The minima for a specific type of approach and landing procedure are considered applicable if:
 - (1) the ground equipment shown on the respective chart required for the intended procedure is operative;
 - (2) the aeroplane systems required for the type of approach are operative;
 - (3) the required aeroplane performance criteria are met; and
 - (4) the crew is qualified accordingly.



- (d) In establishing the aerodrome operating minima which will apply to any particular operation, the operator shall take full account of:
- (1) the type, performance and handling characteristics of the aeroplane and any conditions or limitations stated in the flight manual;
 - (2) the composition of the flight crew, their competence and experience;
 - (3) the dimensions and characteristics of the runways which may be selected for use;
 - (4) the adequacy and performance of the available visual and non-visual ground aids; (See Appendix 1 to OPS 1.430 Table 6a).
 - (5) the equipment available on the aeroplane for the purpose of navigation, acquisition of visual references and/or control of the flight path during the approach, landing and the missed approach;
 - (6) the obstacles in the approach and missed approach areas and the obstacle clearance altitude/height for the instrument approach procedures;
 - (7) the means used to determine and report meteorological conditions;
 - (8) the obstacles in the climb-out areas and necessary clearance margins;
 - (9) the conditions prescribed in the operations specifications; and
 - (10) any minima that may be promulgated by the State of the Aerodrome.

OPS 1.230 Instrument Departure and Approach Procedures

- (a) The operator shall ensure that instrument departure and approach procedures established by the State in which the aerodrome is located are used.
- (b) Notwithstanding sub-paragraph (a) above, a commander may accept an ATC clearance to deviate from a published departure or arrival route, provided obstacle clearance criteria are observed and full account is taken of the operating conditions. The final approach must be flown visually or in accordance with the established instrument approach procedure.
- (c) Different procedures to those required to be used in accordance with sub-paragraph (a) above may only be implemented by the operator provided they have been approved by the State in which the aerodrome is located, if required, and accepted by the Authority.
- (d) One or more instrument approach procedures designed in accordance with the classification of instrument approach and landing operations shall be approved and promulgated by the Authority, as the State in which the aerodrome is located, to serve each instrument runway or aerodrome utilized for instrument flight operations.

OPS 1.235 Noise Abatement Procedures

(See OPS 1.192)

(See AC OPS 1.235)

The operator shall establish appropriate operating departure and arrival/approach procedures for each aircraft type in accordance with the following:



- (a) The operator shall ensure that safety has priority over noise abatement, and
- (b) These procedures shall be designed to be simple and safe to operate with no significant increase in crew workload during critical phases of flight, and
- (c) For each aeroplane type two departure procedures shall be defined, in accordance with ICAO Doc. 8168 (Procedures for Air Navigation Services, “PANS-OPS”), Volume I:
 - (1) noise abatement departure procedure one (NADP 1), designed to meet the close-in noise abatement objective; and
 - (2) noise abatement departure procedure two (NADP 2), designed to meet the distant noise abatement objective; and
 - (3) in addition, each NADP climb profile can only have one sequence of actions.

Note 1: Noise abatement procedures specified by the operator for any one aeroplane type should be the same for all aerodromes.

Note 2: A single procedure may not satisfy requirements at some aerodromes.

OPS 1.240 Routes and Areas of Operation

- (a) The operator shall ensure that a flight will not be commenced unless it has been ascertained by every reasonable means available that the ground and/or water facilities available and directly required on such flight, for the safe operation of the aeroplane and the protection of the passengers, are adequate for the type of operation under which the flight is to be conducted and are adequately operated for this purpose.
- (b) The operator shall ensure that a flight will not commence or continue as planned unless it has been ascertained by every reasonable means available that the airspace containing the intended route from aerodrome of departure to aerodrome of arrival, including the intended take-off, destination and en-route alternate aerodromes, can be safely used for the planned operation. When intending to operate over or near conflict zones, a risk assessment shall be conducted and appropriate risk mitigation measures taken to ensure a safe flight.

Note: “Reasonable means” is intended to denote the use, at the point of departure for (a) and (b) above, or while the aircraft is in flight for (b) above, of information available to the operator either through official information published by the aeronautical information services or readily obtainable from other sources.

- (c) The operator shall ensure that any inadequacy of facilities observed in the course of operations is reported to the authority responsible for them, without undue delay.
- (d) Subject to their published conditions of use, aerodromes and their facilities shall be kept continuously available for flight operations during their published hours of operations, irrespective of weather conditions.
- (e) The operator shall ensure that operations are only conducted along such routes or within such areas, for which:
 - (1) Ground facilities and services, including meteorological services, are provided which are adequate for the planned operation;



- (2) The performance of the aeroplane intended to be used is adequate to comply with minimum flight altitude requirements;
 - (3) The equipment of the aeroplane intended to be used meets the minimum requirements for the planned operation;
 - (4) Appropriate maps and charts are available (OPS 1.135(a)(9) refers);
 - (5) If two-engine aeroplanes are used, adequate aerodromes are available within the time/distance limitations of OPS 1.245.
 - (6) Except for aircraft approved under OPS 1.526, if single-engine aeroplanes are used surfaces are available which permit a safe forced landing to be executed.
- (f) The operator shall ensure that operations are conducted in accordance with any restriction on the routes or the areas of operation, imposed by the Authority.

OPS 1.241 Operation in Defined Airspace with Reduced Vertical Separation Minima (RVSM)

- (a) The operator shall not operate an aeroplane in defined portions of airspace where, based on Regional Air Navigation Agreement, a vertical separation minimum of 300m (1000ft) applies unless issued with a specific approval by the Authority. (See also OPS 1.872).
- (b) Prior to granting a specific approval for RVSM operations, the Authority shall be satisfied that:
 - (1) the vertical navigation performance capability of the aeroplane satisfies the requirements of Appendix 1 to OPS 1.241(b)(1);
 - (2) the operator has instituted appropriate procedures in respect of continued airworthiness (maintenance and repair) practices and programmes; and
 - (3) the operator has instituted appropriate flight crew procedures for operations in RVSM airspace.
- (c) The Authority, in consultation with the State of Registry if appropriate, shall ensure that, in respect of those aeroplanes approved for RVSM operations, adequate provisions exist for:
 - (1) receiving the reports of height-keeping performance issued by the monitoring agencies; and
 - (2) taking immediate corrective action for individual aircraft, or aircraft type groups, identified in such reports as not complying with the height-keeping requirements for operation in airspace where RVSM is applied.

Note: An RVSM specific approval is valid globally on the understanding that any operating procedures specific to a given region will be stated in the Operations Manual or appropriate crew guidance.

- (d) The Authority, where responsible for airspace where RVSM has been implemented, or has issued RVSM specific approvals to operators, shall establish provisions and procedures which ensure that appropriate action will be taken in respect of aircraft and operators found to be operating in RVSM airspace without a valid RVSM specific approval.



- (e) The operator shall ensure that a minimum of two aeroplanes of each aircraft type grouping of the operator have their height-keeping performance monitored, at least once every two years or within intervals of 1000 flight hours per aeroplane, whichever period is longer. If the operator aircraft type grouping consists of a single aeroplane, monitoring of that aeroplane shall be accomplished within the specified period.

OPS 1.243 Operations in Areas with Specified Navigation Performance Requirements
(See AC OPS 1.243)

- (a) The Authority shall, for operations where a navigation specification for PBN has been prescribed, ensure that the operator has established and documented:
- (1) normal and abnormal procedures including contingency procedures;
- Note: Electronic navigation data management is an integral part of normal and abnormal procedures.*
- (2) flight crew qualification and proficiency requirements in accordance with the appropriate navigation specifications;
 - (3) a training programme for relevant personnel consistent with the intended operations; and
 - (4) appropriate maintenance procedures to ensure continued airworthiness in accordance with the appropriate navigation specifications.
- (b) The Authority shall issue a specific approval for operations based on PBN authorisation required (AR) navigation specifications.

(See also OPS 1.865(d)(2) and 1.870)

OPS 1.245 Maximum Distance from an Adequate Aerodrome without an EDTO Approval
(See OPS 1.192)

(See AMC OPS 1.245(a))

(See AMC OPS 1.245(d)(1))

(See AMC OPS 1.245(a)(2)(ii))

- (a) Unless the Authority, as the State of the Operator, has issued a specific approval for EDTO under OPS 1.246(a), an aeroplane with two or more turbine engines shall not be operated on a route where the diversion time from any point on the route, calculated in ISA and still air conditions at the one-engine inoperative cruise speed for aeroplanes with two turbine engines and at the all-engine operating cruise speed for aeroplanes with more than two turbine engines, to an en-route alternate aerodrome exceeds the following threshold times.

Note: When the diversion time exceeds the threshold time, the operation is considered to be an extended diversion time operation (EDTO).

- (1) Performance Class A aeroplanes (OPS 1, Subpart G) with a maximum approved passenger seating configuration of 20 or more;
 - (i) for aeroplanes with two turbine engines, a threshold distance flown in 60 minutes at the one-engine-inoperative cruise speed determined in accordance with subparagraph (b) below; or



- (ii) for aeroplanes with more than two turbine engines, the threshold distance flown in 120 minutes at the all-engine operating cruise speed.
 - (2) Performance Class A aeroplanes (OPS 1, Subpart G) with a maximum approved passenger seating configuration of 19 or less; and
 - (i) for aeroplanes with two turbine engines, the threshold distance flown in 120 minutes at the one-engine-inoperative cruise speed determined in accordance with subparagraph (b) below;
 - (ii) for aeroplanes with two turbine engines specifically approved by the Authority, the threshold distance flown up to 180 minutes for turbojet aeroplanes, at the one-engine-inoperative cruise speed determined in accordance with subparagraph (b) below; or (See AMC OPS 1.245(a)(2)(ii))
 - (iii) for aeroplanes with more than two turbine engines, the threshold distance flown in 180 minutes at the all-engine operating cruise speed.
 - (3) Performance Class B (OPS 1, Subpart H) or Class C (OPS 1, Subpart I) aeroplanes:
 - (i) The threshold distance flown in 120 minutes at the one-engine-inoperative cruise speed determined in accordance with subparagraph (b) below; or
 - (ii) 300 nautical miles, whichever is less.
 - (b) The operator shall determine a speed for the calculation of the maximum distance to an adequate aerodrome for each two-engine aeroplane type or variant operated, not exceeding V_{MO} , based upon the true airspeed that the aeroplane can maintain with one-engine-inoperative.
 - (c) The operator must ensure that the following data, specific to each type or variant, is included in the Operations Manual:
 - (1) The one-engine-inoperative cruise speed determined in accordance with subparagraph (b) above; and
 - (2) The maximum distance from an adequate aerodrome determined in accordance with subparagraphs (a) and (b) above.
- Note: The speeds specified above are only intended to be used for establishing the maximum distance from an adequate aerodrome.*
- (d) Operators conducting operations beyond 60 minutes, from a point on a route to an en-route alternate aerodrome shall ensure that:
 - (1) for all aeroplanes:
 - (i) en-route alternate aerodromes are identified; and
 - (ii) the most up-to-date information is provided to the flight crew on identified en-route alternate aerodromes, including operational status and meteorological conditions;



- (2) for aeroplanes with two turbine engines, the most up-to-date information provided to the flight crew indicates that conditions at identified en-route alternate aerodromes will be at or above the operator's established aerodrome operating minima for the operation at the estimated time of use.
- (e) In addition to the requirements in (d), all operators shall ensure that the following are taken into account and provide the overall level of safety intended under these regulations;
 - (1) Operational control and flight dispatch procedures;
 - (2) Operating procedures; and
 - (3) Training programmes.
- (f) Time capability of cargo compartment fire suppression system

All flights should be planned so that the diversion time to an aerodrome where a safe landing could be made does not exceed the cargo compartment fire suppression time capability of the aeroplane, when one is identified in the relevant aeroplane documentation, reduced by an operational safety margin of 15 minutes.

OPS 1.246 Extended Diversion Time Operations (EDTO)

(See OPS 1.192)

(AMC OPS 1.246)

- (a) The operator shall not conduct operations beyond the threshold distance determined in accordance with OPS 1.245 unless a specific approval has been issued by the Authority.
- (b) The specific approval shall identify the applicable threshold time established for each particular aeroplane and engine combination.
- (c) On issuing the specific approval for extended diversion time operations, the Authority shall specify the maximum diversion time granted to the operator for each particular aeroplane and engine combination.
- (d) Prior to conducting an EDTO flight, the operator shall ensure that a suitable EDTO en-route alternate is available, within either the approved diversion time or a diversion time based on the MEL generated serviceability status of the aeroplane, whichever is shorter. (See OPS 1.297(d).)
- (e) In specifying the appropriate maximum diversion time for the operator of a particular aeroplane type engaged in extended diversion time operations the Authority shall ensure that:
 - (1) for all aeroplanes, the operator has in place procedures to prevent the aeroplane being dispatched on a route with diversion times beyond the capability of EDTO significant system time limitation, if any, indicated in the Aeroplane Flight Manual (directly or by reference); and
 - (2) for aeroplanes with two turbine engines, the following is taken into account;
 - (i) the aeroplane is EDTO certified;
 - (ii) the reliability of the propulsion system is acceptable;



- (iii) the operator's maintenance programme and procedures, operating practices, flight dispatch procedures and crew training programmes are acceptable; and
 - (iv) providing the overall level of safety intended by the provisions of these regulations.
 - (3) In addition to the requirements in (e)(2), all operators shall ensure that the following are taken into account and provide the overall level of safety intended under these regulations;
 - (i) Operational control and flight dispatch procedures;
 - (ii) Operating procedures; and
 - (iii) Training programmes.
- (f) Before issuing a specific approval the Authority shall take into account the route to be flown, the anticipated operating conditions and the location of adequate en-route alternate aerodromes.
- (g) Operators conducting operations beyond 60 minutes, from a point on a route to an en-route alternate aerodrome shall ensure that:
 - (1) for all aeroplanes:
 - (i) en-route alternate aerodromes are identified;
 - (ii) the most up-to-date information is provided to the flight crew on identified en-route alternate aerodromes, including operational status and meteorological conditions; and
 - (iii) operational control, flight dispatch procedures, operating procedures and training programmes are considered.
 - (2) for aeroplanes with two turbine engines, the most up-to-date information provided to the flight crew indicates that conditions at identified en-route alternate aerodromes will be at or above the operator's established aerodrome operating minima for the operation at the estimated time of use.
- (h) A flight shall not proceed beyond the threshold time in accordance with OPS 1.245 unless the identified en-route alternate aerodromes have been re-evaluated for availability and the most up to date information indicates that, during the estimated time of use, conditions at those aerodromes will be at or above the operator's established aerodrome operating minima for the operation. If any conditions are identified that would preclude a safe approach and landing at that aerodrome during the estimated time of use, an alternative course of action shall be determined.
- (i) Notwithstanding the provisions of sub-paragraph (e) above, the Authority may, based on the results of a specific safety risk assessment conducted by the operator which demonstrates how an equivalent level of safety will be maintained, approve operations beyond the time limits of the most time-limited system. The specific safety risk assessment shall include at least the:
 - (1) capabilities of the operator;
 - (2) overall reliability of the aeroplane;
 - (3) reliability of each time limited system;



- (4) relevant information from the aeroplane manufacturer; and
- (5) specific mitigation measures.

Note: For the purpose of EDTO, the destination aerodrome may be considered as an en-route alternate aerodrome.

OPS 1.250 Establishment of Minimum Flight Altitudes

(See AMC OPS 1.250)

- (a) The operator shall establish minimum flight altitudes and the methods to determine those altitudes for all route segments to be flown which provide the required terrain clearance taking into account the requirements of Subparts F to I.
- (b) The operator shall specify the method by which it is intended to determine minimum flight altitudes for operations conducted over routes for which minimum flight altitudes have not been established by the State flown over or the responsible State, and shall include this method in the operations manual. The minimum flight altitudes determined in accordance with the above method shall not be lower than specified in OPS 0.405.
- (c) Every method for establishing minimum flight altitudes must be approved by the Authority.
- (d) Where minimum flight altitudes established by States over-flown are higher than those established by the operator, the higher values shall apply.
- (e) The operator shall take into account the probable effects of the following factors on the safety of the operation in question when establishing minimum flight altitudes:
 - (1) The accuracy and reliability with which the position of the aeroplane can be determined;
 - (2) The probable inaccuracies in the indications of the altimeters used;
 - (3) The characteristics of the terrain (e.g. sudden changes in the elevation) along the routes or in the areas where operations are to be conducted;
 - (4) The probability of encountering unfavourable meteorological conditions (e.g. severe turbulence and descending air currents);
 - (5) Possible inaccuracies in aeronautical charts; and
 - (6) Airspace restrictions.
- (f) In fulfilling the requirements prescribed in sub-paragraph (e) above due consideration shall be given to:
 - (1) corrections for temperature and pressure variations from standard values;
 - (2) the ATC requirements; and
 - (3) any foreseeable contingencies along the planned route.

**OPS 1.255 Fuel Policy**

(See Appendix 1 to OPS 1.255)

(See Appendix 2 to OPS 1.255)

(See AC OPS 1.255)

- (a) The operator shall establish a fuel policy for the purpose of flight planning and in-flight re-planning to ensure that every flight carries sufficient fuel for the planned operation and reserves to cover deviations from the planned operation.
- (b) The operator shall ensure that the planning of flights is at least based upon (1) and (2) below:
- (1) Procedures contained in the Operations Manual and data derived from:
- (i) Data provided by the aeroplane manufacturer; or
 - (ii) Current aeroplane specific data derived from a fuel consumption monitoring system.
- (2) The operating conditions under which the flight is to be conducted including:
- (i) realistic aeroplane fuel consumption data;
 - (ii) anticipated masses;
 - (iii) expected meteorological conditions;
 - (iv) Air Navigation Services provider(s) procedures and restrictions; and
 - (v) the effects of deferred maintenance items and/or configuration deviations.
- (c) The operator shall ensure that the pre-flight calculation of usable fuel required for a flight includes:
- (1) taxi fuel; and
 - (2) trip fuel; and
 - (3) reserve fuel consisting of:
 - (i) contingency fuel (see Appendix 1 to OPS 1.255); and
 - (ii) alternate fuel, if a destination alternate aerodrome is required. (This does not preclude selection of the departure aerodrome as the destination alternate aerodrome); and
 - (iii) final reserve fuel; and

Note: Operators should determine one final reserve fuel value for each aeroplane type and variant in their fleet rounded up to an easily recalled figure.

 - (iv) additional fuel, if required by the type of operation (e.g. EDTO); and
- (4) extra fuel if required by the commander.



- (d) The operator shall ensure that in-flight replanning procedures for calculating usable fuel required when a flight has to proceed along a route or to a destination aerodrome other than originally planned includes:
- (1) trip fuel for the remainder of the flight; and
 - (2) reserve fuel consisting of:
 - (i) contingency fuel; and
 - (ii) alternate fuel, if a destination alternate aerodrome is required. (This does not preclude selection of the departure aerodrome as the destination alternate aerodrome); and
 - (iii) final reserve fuel; and
 - (iv) additional fuel, if required by the type of operation (e.g. EDTO); and
 - (3) extra fuel if required by the commander.

OPS 1.260 Carriage of Persons with Reduced Mobility
(See AC OPS 1.260)

- (a) The operator shall establish procedures for the carriage of Persons with Reduced Mobility (PRMs).
- (b) The operator shall ensure that PRMs are not allocated, nor occupy, seats where their presence could:
- (1) impede the crew in their duties;
 - (2) obstruct access to emergency equipment; or
 - (3) impede the emergency evacuation of the aeroplane.
- (c) The commander must be notified when PRMs are to be carried on board.

OPS 1.265 Carriage of Inadmissible Passengers, Deportees or Persons in Custody

The operator shall establish procedures for the transportation of inadmissible passengers, deportees or persons in custody to ensure the safety of the aeroplane and its occupants. The commander must be notified when the above-mentioned persons are to be carried on board.

OPS 1.270 Stowage of Baggage and Cargo
(See Appendix 1 to OPS 1.270 & AMC OPS 1.270)

- (a) The operator shall establish procedures to ensure that only such hand baggage is taken into the passenger cabin as can be adequately and securely stowed.
- (b) The operator shall establish procedures to ensure that all baggage and cargo on board, which might cause injury or damage, or obstruct aisles and exits if displaced, is placed in stowages designed to prevent movement.

**OPS 1.275 Cargo Compartment Safety**

- (a) The Authority, as the State of the Operator, shall ensure that the operator establishes policy and procedures for the transport of items in the cargo compartment, which include the conduct of a specific safety risk assessment. The risk assessment shall include at least the;
- (1) hazards associated with the properties of the items to be transported;
 - (2) capabilities of the operator;
 - (3) operational considerations (e.g. area of operations, diversion time);
 - (4) capabilities of the aeroplane and its systems (e.g. cargo compartment fire suppression capabilities);
 - (5) containment characteristics of unit load devices;
 - (6) packing and packaging;
 - (7) safety of the supply chain for items to be transported; and
 - (8) quantity and distribution of dangerous goods items to be transported.
- (b) The elements of the cargo compartment(s) fire protection system as approved by the State of Design or State of Registry, and a summary of the demonstrated cargo compartment fire protection certification standards, shall be provided in the aeroplane flight manual or other documentation supporting the operation of the aeroplane.
- (c) The operator shall establish policy and procedures that address the items to be transported in the cargo compartment. These shall ensure to a reasonable certainty that in the event of a fire involving those items, it can be detected and sufficiently suppressed or contained by the elements of the aeroplane design associated with cargo compartment fire protection, until the aeroplane makes a safe landing.

OPS 1.280 Passenger Seating

(See AMC OPS 1.280)

The operator shall establish procedures to ensure that passengers are seated where, in the event that an emergency evacuation is required, they may best assist and not hinder evacuation from the aeroplane.

OPS 1.285 Passenger Briefing

The operator shall ensure that:

- (a) *General.*
- (1) Passengers are given a verbal briefing about safety matters. Parts or all of the briefing may be provided by an audio-visual presentation.
 - (2) Passengers are provided with a safety briefing card on which picture type instructions indicate the operation of emergency equipment and exits likely to be used by passengers.
- (b) *Before take-off*



- (1) Passengers are briefed on the following items if applicable:
 - (i) Smoking regulations;
 - (ii) Back of the seat to be in the upright position and tray table stowed;
 - (iii) Location of emergency exits;
 - (iv) Location and use of floor proximity escape path markings;
 - (v) Stowage of hand baggage;
 - (vi) Restrictions on the use of portable electronic devices; and
 - (vii) The location and the contents of the safety briefing card, and,
 - (2) Passengers receive a demonstration of the following:
 - (i) The use of safety belts and/or safety harnesses, including how to fasten and unfasten the safety belts and/or safety harnesses;
 - (ii) The location and use of oxygen equipment if required (OPS 1.770 and OPS 1.775 refer). Passengers must also be briefed to extinguish all smoking materials when oxygen is being used; and
 - (iii) The location and use of life jackets if required (OPS 1.825 refers).
- (c) *After take-off*
- (1) Passengers are reminded of the following if applicable:
 - (i) Smoking regulations; and
 - (ii) Use of safety belts and/or safety harnesses including the safety benefits of having safety belts fastened when seated irrespective of seat belt sign illumination.
- (d) *Before landing*
- (1) Passengers are reminded of the following if applicable:
 - (i) Smoking regulations;
 - (ii) Use of safety belts and/or safety harnesses;
 - (iii) Back of the seat to be in the upright position and tray table stowed;
 - (iv) Re-stowage of hand baggage; and
 - (v) Restrictions on the use of portable electronic devices.
- (e) *After landing*
- (1) Passengers are reminded of the following:



- (i) Smoking regulations; and
 - (ii) Use of safety belts and/or safety harnesses.
- (f) In an emergency during flight, passengers are instructed in such emergency action as may be appropriate to the circumstances.

OPS 1.290 Flight Preparation

- (a) The operator shall ensure that an operational flight plan is completed for each intended flight. The operational flight plan shall be approved and signed by the commander and, where applicable, signed by the flight operations officer/flight dispatcher, and a copy shall be filed with the operator or a designated agent, or, if these procedures are not possible, it shall be left with the aerodrome authority or on record in a suitable place at the point of departure.
- (b) The commander shall not commence a flight unless he is satisfied that:
- (1) The aeroplane is airworthy;
 - (2) The aeroplane is not operated contrary to the provisions of the Configuration Deviation List (CDL);
 - (3) The instruments and equipment required for the flight to be conducted, in accordance with Subparts K and L, are available;
 - (4) The instruments and equipment are in operable condition except as provided in the MEL;
 - (5) Those parts of the Operations Manual which are required for the conduct of the flight are available;
 - (6) The documents, appropriate certificates (i.e. airworthiness, registration, insurance etc.) additional information and forms required to be available by OPS 1.125 and OPS 1.135 are on board;
 - (7) Current maps, charts and associated documentation or equivalent data are available to cover the intended operation of the aeroplane including any diversion which may reasonably be expected. This shall include any conversion tables necessary to support operations where metric heights, altitudes and flight levels must be used;
 - (8) Ground facilities and services required for the planned flight are available and adequate;
 - (9) The provisions specified in the Operations Manual in respect of fuel, oil and oxygen requirements, minimum safe altitudes, aerodrome operating minima and availability of alternate aerodromes, where required, can be complied with for the planned flight;
 - (10) The load is properly distributed and safely secured;
 - (11) The mass of the aeroplane, at the commencement of take-off roll, will be such that the flight can be conducted in compliance with Subparts F to I as applicable; and
 - (12) Any operational limitation in addition to those covered by sub-paragraphs (9) and (11) above can be complied with.

**OPS 1.295 Selection of Aerodromes**

- (a) The operator shall establish procedures for the selection of destination and/or alternate aerodromes in accordance with OPS 1.220 when planning a flight.
- (b) Take-off Alternate. The operator must select, and specify in the operational flight plan, a take-off alternate aerodrome if either the meteorological conditions at the aerodrome of departure are below the operator's established aerodrome landing minima for that operation or if it would not be possible to return to the departure aerodrome for other reasons. The take-off alternate aerodrome in relation to the departure aerodrome shall be located within the following flight time from the aerodrome of departure:
- (1) For two-engine aeroplanes, one hour of flight time at a one-engine-inoperative cruising speed determined from the Aircraft Flight Manual (AFM) in still air standard conditions based on the actual take-off mass. If the AFM does not contain a one-engine-inoperative cruising speed, the speed to be used for calculation must be that which is achieved with the remaining engine(s) set at maximum continuous power.
 - (2) For aeroplanes with three engines or more, two hours of flight time at an all-engine operating cruising speed determined from the AFM in still air standard conditions based on the actual take-off mass.
 - (3) for aeroplanes engaged in extended diversion time operations (EDTO) where an alternate aerodrome meeting the distance criteria of (1) or (2) is not available, the first available alternate aerodrome located within the distance of the operator's specified maximum diversion time considering the actual take-off mass.

Note: For the purpose of EDTO, the take-off aerodrome may be considered as an en-route alternate aerodrome.

- (c) Destination Alternate. For a flight to be conducted in accordance with IFR, at least one destination alternate aerodrome shall be selected and specified in the operational and ATS flight plans, unless:
- (1) the duration of the planned flight from the departure aerodrome, or from the point of in-flight re-planning is such that, taking into account all meteorological and operational information relevant to the flight, at the estimated time of use, a reasonable certainty exists that;
 - (i) the approach and landing may be made under VFR; and
 - (ii) separate runways are available and usable at the estimated time of use of the destination aerodrome with at least one runway having an operational instrument approach procedure;or
 - (2) the destination aerodrome is isolated. Operations into isolated aerodromes do not require the selection of a destination alternate aerodrome(s) and shall be planned in accordance with OPS 1.255(d) and;
 - (i) for each flight into an isolated aerodrome a point of no return shall be determined; and



- (ii) a flight to be conducted to an isolated aerodrome shall not be continued past the point of no return unless a current assessment of meteorological conditions, traffic, and other operational conditions indicate that a safe landing can be made at the estimated time of use.
- (d) Two destination alternate aerodromes shall be selected when, for the destination aerodrome;
 - (1) the appropriate weather reports or forecasts for the destination, or any combination thereof, indicate that during a period commencing one hour before and ending one hour after the estimated time of arrival, the weather conditions will be below the applicable planning minima (See OPS 1.297(b); or
 - (2) no meteorological information is available.
- (e) The operator shall select and specify any required alternate aerodrome(s), including enroute alternate aerodromes required for EDTO by aeroplanes with two turbine engines, in the operational and ATS flight plans.
- (f) Notwithstanding the provisions above, the Authority, as the State of the Operator, may, based on the results of a specific safety risk assessment conducted by the operator which demonstrates how an equivalent level of safety will be maintained, approve operational variations to alternate aerodrome selection criteria. The specific safety risk assessment shall include at least the:
 - (1) capabilities of the operator;
 - (2) overall capability of the aeroplane and its systems;
 - (3) available aerodrome technologies, capabilities and infrastructure;
 - (4) quality and reliability of meteorological information;
 - (5) identified hazards and safety risks associated with each alternate aerodrome variation; and
 - (6) specific mitigation measures.

OPS 1.297 Planning Minima for IFR Flights

- (a) *Planning minima for a take-off alternate aerodrome.* The operator shall only select an aerodrome as a take-off alternate aerodrome when the appropriate weather reports or forecasts or any combination thereof indicate that, during a period commencing one hour before and ending one hour after the estimated time of arrival at the aerodrome, the weather conditions will be at or above the applicable landing minima specified in accordance with OPS 1.225. The ceiling must be taken into account when the only approaches available are non-precision and/or circling approaches. Any limitation related to one-engine-inoperative operations must be taken into account.
- (b) *Planning minima for a destination aerodrome (except isolated destination aerodromes).* The operator shall only select the destination aerodrome when;
 - (1) the appropriate weather reports or forecasts, or any combination thereof, indicate that, during a period commencing one hour before and ending one hour after the estimated time of arrival at the aerodrome, the weather conditions will be at or above the applicable planning minima as follows:



- (i) RVR/visibility specified in accordance with OPS 1.225; and
 - (ii) For a non-precision approach or a circling approach, the ceiling at or above MDH; or
- (2) Two destination alternate aerodromes are selected under OPS 1.295(d).
- (c) Planning minima for a:
- (1) destination alternate aerodrome, or
 - (2) isolated aerodrome, or
 - (3) 3% ERA Aerodrome, or
 - (4) en-route alternate aerodrome required at the planning stage

The operator shall only select an aerodrome for one of those purposes when the appropriate weather reports or forecasts, or any combination thereof, indicate that, during a period commencing one hour before and ending one hour after the estimated time of arrival at the aerodrome, the weather conditions will be at or above the planning minima in Table 1 below.

Table 1 Planning minima – Destination alternate aerodrome, isolated destination aerodrome, 3% ERA and en-route alternate aerodrome

Type of approach	Planning Minima
Cat II and III	Cat I (<i>Note 1</i>)
Cat I	Non-precision (<i>Notes 1 & 2</i>)
Non-precision	Non-precision (<i>Notes 1 & 2</i>) plus 200 ft/1000 m
Circling	Circling

Note 1: RVR.

Note 2: The ceiling must be at or above the MDH.

- (d) *Planning minima for an EDTO en-route alternate aerodrome.* the operator shall only select an aerodrome as an EDTO en-route alternate aerodrome when the appropriate weather reports or forecasts, or any combination thereof, indicate that, between the anticipated time of landing until one hour after the latest possible time of landing, conditions calculated by adding the additional limits of Table 2 will exist. the operator shall include in his Operations Manual the method for determining the operating minima at the planned EDTO en-route alternate aerodrome.

Table 2 Planning minima – EDTO

Approach Facility	Alternate Airfield Ceiling	Weather Minima Visibility/RVR
Precision Approach Procedure	Authorised DH/DA plus an increment of 200 ft	Authorised visibility plus an increment of 800 metres
Non-precision approach or circling approach	Authorised MDH/MDA plus an increment of 400 ft	Authorised visibility plus an increment of 1500 metres



- (e) Notwithstanding the provisions in Tables 1 and 2 above, the Authority shall approve a margin of time established by the operator for the estimated time of use of an aerodrome provided that the operator specifies appropriate incremental values, acceptable to the Authority, for height of cloud base and visibility to be added to the operator's established aerodrome operating minima, and can ensure that an adequate margin of safety is observed in determining whether or not an approach and landing can be safely carried out at each alternate aerodrome.

OPS 1.300 Submission of ATS Flight Plan

(See AMC OPS 1.300)

The operator shall ensure that a flight is not commenced unless an ATS flight plan has been submitted, or adequate information has been deposited in order to permit alerting services to be activated if required.

OPS 1.305 Refuelling/Defueling with Passengers Embarking, on Board or Disembarking

(See Appendix 1 to OPS 1.305)

(See AMC OPS 1.305)

The operator shall ensure that no aeroplane is refuelled/defueled with Avgas or wide cut type fuel (e.g. Jet-B or equivalent) or when a mixture of these types of fuel might occur, when passengers are embarking, on board or disembarking. In all other cases necessary precautions must be taken and the aeroplane must be properly manned by qualified personnel ready to initiate and direct an evacuation of the aeroplane by the most practical and expeditious means available.

OPS 1.307 Refuelling/Defueling with Wide-cut Fuel

(See AMC OPS 1.307)

The operator shall establish procedures for refuelling/defueling with wide-cut fuel (e.g. Jet-B or equivalent) if this is required.

OPS 1.308 Push Back and Towing

(See AC OPS 1.308)

- (a) The operator shall ensure that all push back and towing procedures comply with appropriate aviation standards and procedures.
- (b) The operator shall ensure that pre- or post-taxi positioning of the aeroplane is not executed by towbarless towing unless
- (1) an aeroplane is protected by its own design from damage to the nose wheel steering system due to towbarless towing operation, or
 - (2) a system/procedure is provided to alert the flight crew that such damage may have or has occurred, or
 - (3) the towbarless towing vehicle is designed to prevent damage to the aeroplane type.

OPS 1.310 Crew Members at Stations

- (a) Flight crew members

- (1) During take-off and landing each flight crew member required to be on flight deck duty shall be at his/her station.



- (2) During all other phases of flight each flight crew member required to be on flight deck duty shall remain at his station unless his/her absence is necessary for the performance of his duties in connection with the operation, or for physiological needs provided at least one suitably qualified pilot remains at the controls of the aeroplane at all times.
- (3) During all phases of flight each flight crew member required to be on flight deck duty shall remain alert. If a lack of alertness is encountered, appropriate countermeasures shall be used. If unexpected fatigue is experienced a controlled rest procedure, organised by the commander, can be used if workload permits (see AC OPS 1.310(a)(3)). Controlled rest taken in this way may never be considered to be part of a rest period for purposes of calculating flight time limitations nor used to justify any duty period.

(b) Cabin crew members.

On all the decks of the aeroplane that are occupied by passengers, required cabin crew members shall be seated at their assigned stations during take-off and landing during critical phases of flight. (See AMC OPS 1.310(b)).

OPS 1.311 Minimum Number of Cabin Crew Required to be on Board an Aeroplane during Ground Operations with Passengers

(See Appendix 1 to OPS 1.311)

(See AC OPS 1.311(b)(i))

The operator shall ensure that, whenever any passengers are on board an aeroplane, the minimum number of cabin crew required in accordance with OPS 1.990(a), (b), (c) and (d) are present in the passenger cabin, except:

- (a) when the aeroplane is on the ground at a parking place, the number of cabin crew present in the passenger cabin may be reduced below the number determined by OPS 1.990(a), (b) and (c). The minimum number of cabin crew required in these circumstances shall be one per pair of floor-level emergency exits on each passenger deck, or one for every 50, or fraction of 50, passengers present on board, whichever is greater, provided that:
 - (1) the operator has established a procedure for the evacuation of passengers with this reduced number of cabin crew that has been accepted by the Authority as providing equivalent safety; and
 - (2) no refuelling/defuelling is taking place; and
 - (3) the senior cabin crew member has performed the pre-boarding safety briefing to the cabin crew; and
 - (4) the senior cabin crew member is present in the passenger cabin; and
 - (5) the pre-boarding cabin checks have been completed.

This reduction is not permitted when the number of cabin crew is determined by using OPS 1.990(d).

- (b) during disembarkation when the number of passengers remaining on board is less than 20, the minimum number of cabin crew present in the passenger cabin may be reduced below the minimum number of cabin crew required in accordance with OPS 1.990(a), (b), (c) and (d), provided that:



- (1) the operator has established a procedure for the evacuation of passengers with this reduced number of cabin crew that has been accepted by the Authority as providing equivalent safety; and
- (2) the senior cabin crew member is present in the passenger cabin.

OPS 1.313 Use of Headset

- (a) Each flight crew member required to be on flight deck duty shall wear the headset with boom microphone or equivalent required by OPS 1.650(p) and/or OPS 1.652(s) and use it as the primary device to listen to the voice communications with Air Traffic Services:
 - (1) on the ground:
 - (i) when receiving the ATC departure clearance via voice communication,
 - (ii) when engines are running,
 - (2) in flight below transition altitude or 10,000 feet, whichever is higher, and
 - (3) whenever deemed necessary by the commander.
- (b) In the conditions of paragraph (a) above, the boom microphone or equivalent shall be in a position which permits its use for two-way radio communications.

OPS 1.315 Assisting Means for Emergency Evacuation

The operator shall establish procedures to ensure that before taxiing, take-off and landing, and when safe and practicable to do so, an assisting means for emergency evacuation that deploys automatically, is armed.

OPS 1.320 Seats, Safety Belts and Harnesses

- (a) Crew members
 - (1) During take-off and landing, and whenever deemed necessary by the commander in the interest of safety, each crew member shall be properly secured by all safety belts and harnesses provided.
 - (2) During other phases of the flight each flight crew member on the flight deck shall keep his safety belt fastened while at his station.
- (b) Passengers
 - (1) Before take-off and landing, and during taxiing, and whenever deemed necessary in the interest of safety, the commander shall ensure that each passenger on board occupies a seat or berth with his safety belt, or harness where provided, properly secured.
 - (2) The operator shall make provision for, and the commander shall ensure that multiple occupancy of aeroplane seats may only be allowed on specified seats and does not occur other than by one adult and one infant who is properly secured by a supplementary loop belt or other restraint device.

**OPS 1.325 Securing of Passenger Cabin and Galley(s)**

- (a) The operator shall establish procedures to ensure that before taxiing, take-off and landing all exits and escape paths are unobstructed.
- (b) The commander shall ensure that before take-off and landing, and whenever deemed necessary in the interest of safety, all equipment and baggage is properly secured.

OPS 1.330 Accessibility of Emergency Equipment

The commander shall ensure that relevant emergency equipment remains easily accessible for immediate use.

OPS 1.335 Smoking on Board

- (a) The commander shall ensure that no person on board is allowed to smoke:
 - (1) whenever deemed necessary in the interest of safety;
 - (2) while the aeroplane is on the ground unless specifically permitted in accordance with procedures defined in the Operations Manual;
 - (3) outside designated smoking areas, in the aisle(s) and in the toilet(s);
 - (4) in cargo compartments and/or other areas where cargo is carried which is not stored in flame resistant containers or covered by flame resistant canvas; and
 - (5) in those areas of the cabin where oxygen is being supplied.

OPS 1.340 Meteorological Conditions

- (a) On an IFR flight a commander shall only:
 - (1) commence take-off; or
 - (2) continue beyond the point from which a revised flight plan applies in the event of in-flight replanning,when information is available indicating that the expected weather conditions at the time of arrival at the destination and/or required alternate aerodrome(s) prescribed in OPS 1.295 are at or above the planning minima, prescribed in OPS 1.297.
- (b) On an IFR flight, a commander shall only continue towards the planned destination aerodrome when the latest information available indicates that, at the expected time of arrival, the weather conditions at the destination, or at least one destination alternate aerodrome, are at or above the applicable aerodrome operating minima
- (c) On an IFR flight a commander shall only continue beyond:
 - (1) the decision point when using the Reduced Contingency Fuel Procedure (See Appendix 1 to OPS 1.255); or
 - (2) the pre-determined point when using the pre-determined point procedure (See Appendix 1 to OPS 1.255),



when information is available indicating that the expected weather conditions, at the time of arrival at the destination and/or required alternate aerodrome(s) prescribed in OPS 1.295 are at or above the applicable aerodrome operating minima prescribed in OPS 1.225.

- (d) A flight to be conducted in accordance with VFR shall not be commenced unless current meteorological reports or a combination of current reports and forecasts indicate that the meteorological conditions along the route or that part of the route to be flown under the VFR will, at the appropriate time, be such as to enable compliance with these rules.
- (e) To ensure that an adequate margin of safety is observed in determining whether or not an approach and landing can be safely carried out at each alternate aerodrome, the operator shall specify appropriate incremental values for height of cloud base and visibility, acceptable to the Authority, as the State of the Operator, to be added to the operator's established aerodrome operating minima.
- (f) The Authority, as the State of the Operator, shall approve a margin of time established by the operator for the estimated time of use of an aerodrome.

OPS 1.345 Ice and Other Contaminants – Ground Procedures

(See AC OPS 1.345)

- (a) The operator shall establish procedures to be followed when ground de-icing and anti-icing and related inspections of the aeroplane(s) are necessary.
- (b) A flight to be planned or expected to operate in suspected or known ground icing conditions shall not take-off unless the aeroplane has been inspected for icing and, if necessary, has been given appropriate de-icing/anti-icing treatment. Accumulation of ice or other naturally occurring contaminants shall be removed so that the aeroplane is kept in an airworthy condition prior to take-off.
- (c) A commander shall not commence take-off unless the external surfaces are clear of any deposit which might adversely affect the performance and/or controllability of the aeroplane except as permitted in the Aeroplane Flight Manual.

OPS 1.346 Ice and Other Contaminants – Flight Procedures

- (a) The operator shall establish procedures for flights in expected or actual icing conditions. (See AC OPS 1.346 and OPS 1.675)
- (b) A commander shall not commence a flight nor intentionally fly into expected or actual icing conditions unless the aeroplane is certificated and equipped to cope with such conditions.

OPS 1.350 Fuel and Oil Supply

- (a) A commander shall only commence a flight, or continue in the event of in-flight replanning, when he/she is satisfied that the aeroplane carries at least the planned amount of usable fuel and oil to complete the flight safely, taking into account the expected operating conditions.
- (b) The operator shall maintain fuel records to enable the Authority, as the State of the Operator, to ascertain that, for each flight, the requirements of this Subpart have been complied with.



- (c) The operator shall maintain oil records to enable the Authority, as the State of the Operator, to ascertain that trends for oil consumption are such that an aeroplane has sufficient oil to complete each flight.

OPS 1.355 Take-off Conditions

Before commencing take-off, a commander must satisfy himself/herself that, according to the information available to him, the weather at the aerodrome and the condition of the runway intended to be used should not prevent a safe take-off and departure.

OPS 1.360 Application of Take-off Minima

Before commencing take-off, a commander must satisfy himself/herself that the RVR or visibility in the take-off direction of the aeroplane is equal to or better than the applicable minimum.

OPS 1.365 Minimum Flight Altitudes

(See AMC OPS 1.250)

The commander or the pilot to whom conduct of the flight has been delegated shall not fly below specified minimum altitudes except when necessary for take-off or landing.

OPS 1.370 Simulated Abnormal Situations in Flight

The operator shall establish procedures to ensure that abnormal or emergency situations requiring the application of part or all of abnormal or emergency procedures and simulation of IMC by artificial means are not simulated during commercial air transportation flights.

OPS 1.375 In-flight Fuel Management

The operator must establish a procedure to ensure that in-flight fuel checks and fuel management are carried out according to following criteria:-

- (a) In-flight fuel checks.
- (1) A commander must ensure that fuel checks are carried out in-flight at regular intervals. The usable remaining fuel must be recorded and evaluated to:
 - (i) compare actual consumption with planned consumption;
 - (ii) check that the usable remaining fuel is sufficient to complete the flight, in accordance with paragraph (b) 'In-flight fuel management' below; and
 - (iii) determine the expected usable fuel remaining on arrival at the destination aerodrome.
 - (2) The relevant fuel data must be recorded.
- (b) In-flight fuel management.
- (1) The flight must be conducted so that the expected usable fuel remaining on arrival at the destination aerodrome is not less than:
 - (i) the required alternate fuel plus final reserve fuel, or



- (ii) the final reserve fuel if no alternate aerodrome is required.
- (2) The use of fuel after flight commencement for purposes other than originally intended during pre-flight planning shall require a re-analysis and, if applicable, adjustment of the planned operation.
- (3) However, if, as a result of an in-flight fuel check, the expected usable fuel remaining on arrival at the destination aerodrome is less than:
- (i) the required alternate fuel plus final reserve fuel, the commander must take into account the traffic and the operational conditions prevailing at the destination aerodrome, at the destination alternate aerodrome and at any other adequate aerodrome, in deciding whether to proceed to the destination aerodrome or to divert so as to perform a safe landing with not less than final reserve fuel, or
 - (ii) the final reserve fuel if no alternate aerodrome is required, the commander must take appropriate action and proceed to an adequate aerodrome so as to perform a safe landing with not less than final reserve fuel.

Note: The protection of final reserve fuel is intended to ensure a safe landing at any aerodrome when unforeseen occurrences may not permit safe completion of an operation as originally planned.

- (4) (i) The pilot-in-command shall request delay information from ATC when unanticipated circumstances may result in landing at the destination aerodrome with less than the final reserve fuel plus any fuel required to proceed to an alternate aerodrome or the fuel required to operate to an isolated aerodrome.
- (ii) The pilot-in-command shall advise ATC of a minimum fuel state by declaring “Minimum Fuel” when, having committed to land at a specific aerodrome, the pilot calculates that any change to the existing clearance to that aerodrome may result in landing with less than planned final reserve fuel.

Note: The declaration of “Minimum Fuel” informs ATC that all planned aerodrome options have been reduced to a specific aerodrome of intended landing and any change to the existing clearance may result in landing with less than planned final reserve fuel. This is not an emergency situation but an indication that an emergency situation is possible should any additional delay occur.

- (iii) The commander shall declare an emergency (“Mayday, Mayday, Mayday – Fuel”) when calculated usable fuel on landing at the nearest adequate aerodrome where a safe landing can be performed is less than final reserve fuel.
- (5) Additional conditions for specific procedures.
- (i) On a flight using the RCF procedure, in order to proceed to the Destination 1 aerodrome, the commander must ensure that the usable fuel remaining at the decision point is at least the total of:
 - (A) trip fuel from the decision point to the Destination 1 aerodrome; and



- (B) contingency fuel equal to 5% of trip fuel from the decision point to the Destination 1 aerodrome; and
 - (C) destination 1 aerodrome alternate fuel, if a Destination 1 alternate aerodrome is required; and
 - (D) final reserve fuel.
- (ii) On a flight using the PDP procedure in order to proceed to the destination aerodrome, the commander must ensure that the usable fuel remaining at the PDP is at least the total of:
- (A) trip fuel from the PDP to the destination aerodrome; and
 - (B) contingency fuel from the PDP to the destination aerodrome calculated in accordance with Appendix 1 to OPS 1.255 paragraph (a)(3); and
 - (C) fuel required according to Appendix 1 to OPS 1.255 paragraph (c)(1)(iv).

OPS 1.385 Use of Supplemental Oxygen

A commander shall ensure that flight crew members engaged in performing duties essential to the safe operation of an aeroplane in flight use supplemental oxygen continuously whenever cabin altitude exceeds 10000 ft for a period in excess of 30 minutes and whenever the cabin altitude exceeds 13000 ft.

OPS 1.390 Cosmic Radiation

- (a) The operator shall take account of the in-flight exposure to cosmic radiation of all crew members while on duty (including positioning) and shall take the following measures for those crew liable to be subject to exposure of more than 1 mSv per year (See AC OPS 1.390(a)(1));
- (1) Assess their exposure;
 - (2) Take into account the assessed exposure when organising working schedules with a view to reduce the doses of highly exposed crew members (See AC OPS 1.390(a)(2));
 - (3) Inform the crew members concerned of the health risks their work involves (See AC OPS 1.390(a)(3));
 - (4) Ensure that the working schedules for female crew members, once they have notified the operator that they are pregnant, keep the equivalent dose to the foetus as low as can reasonably be achieved and in any case ensure that the dose does not exceed 1 mSv for the remainder of the pregnancy;
 - (5) Ensure that individual records are kept for those crew members who are liable to high exposure. These exposures are to be notified to the individual on an annual basis, and also upon leaving the operator.
- (b) The operator shall not operate an aeroplane above 15000m (49000ft) unless the equipment specified in OPS 1.680(a)(1) is serviceable, or the procedure prescribed in OPS 1.680(a)(2) is complied with.



- (c) The commander or the pilot to whom conduct of the flight has been delegated shall initiate a descent as soon as practicable when the limit values of cosmic radiation dose rate specified in the Operations Manual are exceeded. (See OPS 1.680(a)(1))

OPS 1.395 Ground Proximity Detection

When undue proximity to the ground is detected by any flight crew member or by a ground proximity warning system, the commander or the pilot to whom conduct of the flight has been delegated shall ensure that corrective action is initiated immediately to establish safe flight conditions.

OPS 1.398 Use of Airborne Collision Avoidance System (ACAS)

(See AC OPS 1.398)

The operator shall establish procedures to ensure that:

- (a) when ACAS is installed and serviceable, it shall be used in flight in a mode that enables Resolution Advisories (RA) to be produced unless to do so would not be appropriate for conditions existing at the time.
- (b) when undue proximity to another aircraft (RA) is detected by ACAS, the commander or the pilot to whom conduct of the flight has been delegated must ensure that any corrective action indicated by the RA is initiated immediately, unless doing so would jeopardize the safety of the aeroplane. The corrective action must;
- (1) never be in a sense opposite to that indicated by the RA;
 - (2) be in the correct sense indicated by the RA even if this is in conflict with the vertical element of an ATC instruction;
 - (3) be the minimum possible to comply with the RA indication.
- (c) prescribed ACAS ATC communications are specified;
- (d) when the conflict is resolved the aeroplane is promptly returned to the terms of the ATC instructions or clearance;
- (e) unless otherwise specified in an air traffic control instruction, to avoid unnecessary airborne collision avoidance system (ACAS II) Resolution Advisories in aircraft at or approaching adjacent altitudes or flight levels, an aeroplane climbing or descending to an assigned altitude or flight level, especially with an autopilot engaged, may do so at a rate less than 8 m/sec or 1500 ft/min (depending on the instrumentation available) throughout the last 300 m (1000 ft) of climb or descent to the assigned level when the pilot is made aware of another aircraft at or approaching an adjacent altitude or flight level.
- (f) Operators of aircraft equipped with ACAS shall establish standards of training and operation before authorising crews to use ACAS.

OPS 1.400 Approach and Landing Conditions

(See AMC OPS 1.400)

Before commencing an approach to land, the commander must satisfy himself/herself that, according to the information available to him/her, the weather at the aerodrome and the condition of the runway intended to be used should not prevent a safe approach, landing or missed approach, having regard to



the performance information contained in the Operations Manual.

OPS 1.405 Commencement and Continuation of Approach

- (a) The commander or the pilot to whom conduct of the flight has been delegated may commence an instrument approach regardless of the reported RVR/Visibility but the approach shall not be continued below 300 m (1000 ft) above the aerodrome elevation or into the final approach segment unless the reported visibility or controlling RVR is at or above the aerodrome operating minima. (See OPS 1.192)
- (b) Where RVR is not available, RVR values may be derived by converting the reported visibility in accordance with Appendix 1 to OPS 1.430(l).
- (c) If, after entering the final approach segment or after descending below 300 m (1000 ft) above the aerodrome elevation in accordance with (a) above, the reported visibility or controlling RVR falls below the specified minimum, the approach may be continued to DA/H or MDA/H.
- (d) Where no outer marker or equivalent position exists, the commander or the pilot to whom conduct of the flight has been delegated shall make the decision to continue or abandon the approach before descending below 1000 ft above the aerodrome on the final approach segment. If the MDA/H is at or above 1000 ft above the aerodrome, the operator shall establish a height, for each approach procedure, below which the approach shall not be continued if the RVR/visibility is less than the applicable minima.
- (e) The approach may be continued below DA/H or MDA/H and the landing may be completed provided that the required visual reference is established at the DA/H or MDA/H and is maintained.
- (f) In all cases above, an aeroplane shall not continue its approach to land at any aerodrome beyond a point at which the limits of the operating minima specified for that aerodrome would be infringed.
- (g) The touch-down zone RVR is always controlling. If reported and relevant, the midpoint and stop end RVR are also controlling. The minimum RVR value for the mid-point is 125 m or the RVR required for the touch-down zone if less, and 75 m for the stop-end. For aeroplanes equipped with a roll-out guidance or control system, the minimum RVR value for the mid-point is 75 m.

Note. "Relevant", in this context, means that part of the runway used during the high speed phase of the landing down to a speed of approximately 60 knots.

- (h) An approach to land shall not be continued below 300 m (1000 ft) above aerodrome elevation unless the commander is satisfied that, with the runway surface condition information available, the aeroplane performance information indicates that a safe landing can be made.

OPS 1.410 Operating Procedures – Threshold Crossing Height

The operator must establish operational procedures designed to ensure that an aeroplane being used to conduct precision approaches crosses the threshold by a safe margin, with the aeroplane in the landing configuration and attitude.

OPS 1.415 Journey Log

A commander shall ensure that the Journey log is completed.



OPS 1.420 Occurrence Reporting

(a) Terminology

- (1) *Incident.* An occurrence, other than an accident, associated with the operation of an aircraft which affects or could affect the safety of operation.
- (2) *Serious Incident.* An incident involving circumstances indicating that there was a high probability of an accident and associated with the operation of an aircraft which takes place between the time any person boards the aircraft with the intention of flight until such time as all such persons have disembarked.
- (3) *Accident.* An occurrence associated with the operation of an aircraft which, in the case of a manned aircraft, takes place between the time any person boards the aircraft with the intention of flight until such time as all persons have disembarked, or in the case of an unmanned aircraft takes place between the time the aircraft is ready to move with the purpose of flight until such time as it comes to rest at the end of the flight and the primary propulsion system is shut down, in which:
 - (i) a person is fatally or seriously injured as a result of:
 - (A) being in the aircraft;
 - (B) direct contact with any part of the aircraft, including parts which have become detached from the aircraft; or,
 - (C) direct exposure to jet blast;except when the injuries are from natural causes, self-inflicted or inflicted by other persons, or when the injuries are to stowaways hiding outside the areas normally available to the passengers and crew: or
 - (ii) the aircraft sustains damage or structural failure which adversely affects the structural strength, performance or flight characteristics of the aircraft; and would normally require major repair or replacement of the affected component; except for engine failure or damage, when the damage is limited to a single-engine, (including its cowlings or accessories) to propellers, wing tips, antennas, probes, vanes, tires, brakes, wheels, fairings, panels, landing gear doors, windcreens, the aircraft skin (such as small dents or puncture holes), or for minor damages to main rotor blades, tail rotor blades, landing gear and those resulting from hail or bird strike (including holes in the radome); or
 - (iii) the aircraft is missing or is completely inaccessible.

(b) Incident Reporting.

The operator shall establish procedures for reporting incidents taking into account responsibilities described below and circumstances described in sub-paragraph (d) below.

- (1) OPS 1.085(b) specifies the responsibilities of crew members for reporting incidents that endanger, or could endanger, the safety of operation.
- (2) The commander or the operator of an aeroplane shall submit a report to the Authority of any incident that endangers or could endanger the safety of operation.



- (3) Reports must be dispatched within 72 hours of the time when the incident was identified unless exceptional circumstances prevent this.
- (4) A commander shall ensure that all known or suspected technical defects and all exceedances of technical limitations occurring while he was responsible for the flight are recorded in the aircraft technical log. If the deficiency or exceedance of technical limitations endangers or could endanger the safety of operation, the commander must in addition initiate the submission of a report to the Authority in accordance with paragraph (b)(2) above.
- (5) In the case of incidents reported in accordance with sub- paragraphs (b)(1), (b)(2) and (b)(3) above, arising from, or relating to, any failure, malfunction or defect in the aeroplane, its equipment or any item of ground support equipment, or which cause or might cause adverse effects on the continuing airworthiness of the aeroplane, the operator must also inform the organisation responsible for the design or the supplier or, if applicable, the organisation responsible for continued airworthiness, at the same time as a report is submitted to the Authority.

(c) *Accident and Serious Incident Reporting.*

The operator shall establish procedures for reporting accidents and serious incidents taking into account responsibilities described below and circumstances described in sub-paragraph (d) below.

- (1) A commander shall notify the operator of any accident or serious incident occurring while he was responsible for the flight. In the event that the commander is incapable of providing such notification, this task shall be undertaken by any other member of the crew if they are able to do so, note being taken of the succession of command specified by the operator.
- (2) The operator shall ensure that the Authority in the State of the Operator, the nearest appropriate Authority (if not the Authority in the State of the Operator), and any other organisation required by the State of the Operator to be informed, are notified by the quickest means available of any accident or serious incident and, in the case of accidents only, at least before the aeroplane is moved unless exceptional circumstances prevent this.
- (3) The commander or the operator of an aeroplane shall submit a report to the Authority in the State of the Operator within 72 hours of the time when the accident or serious incident occurred.

(d) *Specific Reports.*

Occurrences for which specific notification and reporting methods must be used are described below;

- (1) *Air Traffic Incidents* A commander shall without delay notify the air traffic service unit concerned of the incident and shall inform them of his intention to submit an air traffic incident report after the flight has ended whenever an aircraft in flight has been endangered by:
 - (i) a near collision with any other flying device;
 - (ii) faulty air traffic procedures or lack of compliance with applicable procedures by air traffic services or by the flight crew;



- (iii) failure of air traffic services facilities.

In addition, the commander shall notify the Authority of the incident.

- (2) *Airborne Collision Avoidance System Resolution Advisory* A commander shall notify the air traffic service unit concerned and submit an ACAS report to the Authority whenever an aircraft in flight has manoeuvred in response to an ACAS Resolution Advisory.
- (3) *Bird Hazards and Strikes*
 - (i) A commander shall immediately inform the local air traffic service unit whenever a potential bird hazard is observed.
 - (ii) If he is aware that a bird strike has occurred, a commander shall submit a written bird strike report after landing to the Authority whenever an aircraft for which he is responsible suffers a bird strike that results in significant damage to the aircraft or the loss or malfunction of any essential service. If the bird strike is discovered when the commander is not available, the operator is responsible for submitting the report.
- (4) *Dangerous Goods Incidents and Accidents.* the operator shall report dangerous goods incidents and accidents to the Authority and the appropriate Authority in the State where the accident or incident occurred, as provided for in Appendix 1 to OPS 1.1225. The first report shall be dispatched within 72 hours of the event unless exceptional circumstances prevent this and include the details that are known at that time. If necessary, a subsequent report must be made as soon as possible giving whatever additional information has been established. (See also OPS 1.1225)
- (5) *Unlawful Interference.* Following an act of unlawful interference on board an aircraft, the commander or, in his absence, the operator shall submit a report as soon as practicable to the local Authority and to the Authority in the State of the Operator. (See also OPS 1.1245)
- (6) *Encountering Potential Hazardous Conditions.* A commander shall notify the appropriate air traffic services unit as soon as possible whenever a potentially hazardous condition such as an irregularity in a ground or navigational facility, a meteorological phenomenon or a volcanic ash cloud is encountered during flight.
- (7) *Runway Braking Action.* The commander shall report the runway braking action special air-report (AIREP) when the runway braking action encountered is not as good as reported.



Appendix 1 to OPS 1.241(b)(1)
Height-keeping Performance Requirements
(See OPS 1.241(b)(1))

1. In respect of groups of aeroplanes that are nominally of identical design and build with respect to all details that could influence the accuracy of height-keeping performance, the height-keeping performance capability shall be such that the total vertical error (TVE) for the group of aeroplanes shall have a mean no greater than 25 m (80 ft) in magnitude and shall have a standard deviation no greater than $28 - 0.013z^2$ for $0 \leq z \leq 25$ when z is the magnitude of the mean TVE in metres, or $92 - 0.004z^2$ for $0 \leq z \leq 80$ where z is in feet.
2. In addition, the components of TVE shall have the following characteristics:
 - (a) the mean altimetry system error (ASE) of the group shall not exceed 25 m (80 ft) in magnitude;
 - (b) the sum of the absolute value of the mean ASE and of three standard deviations of ASE shall not exceed 75 m (245 ft); and
 - (c) the differences between cleared flight level and the indicated pressure altitude actually flown shall be symmetric about a mean of 0 m, with a standard deviation no greater than 13.3 m (43.7 ft), and in addition, the decrease in the frequency of differences with increasing difference magnitude shall be at least exponential.
3. In respect of aeroplanes for which the characteristics of the airframe and altimetry system fit are unique and so cannot be classified as belonging to a group of aeroplanes encompassed by paragraph 1, the height-keeping performance capability shall be such that the components of the TVE of the aeroplane have the following characteristics:
 - (a) the ASE of the aeroplane shall not exceed 60 m (200 ft) in magnitude under all flight conditions; and
 - (b) the differences between the cleared flight level and the indicated pressure altitude actually flown shall be symmetric about a mean of 0 m, with a standard deviation no greater than 13.3 m (43.7 ft), and in addition, the decrease in the frequency of differences with increasing difference magnitude shall be at least exponential.



Appendix 1 to OPS 1.255

Fuel Policy

(See OPS 1.255)

The operator must base the company fuel policy, including calculation of the amount of fuel to be on board for departure, on the following planning criteria:

(a) Basic Procedure

The usable fuel to be on board for departure must be the amount of:

- (1) Taxi fuel, which shall be the amount of fuel expected to be consumed before take-off taking into account local conditions at the departure aerodrome and APU fuel consumption.
- (2) Trip fuel, which shall include:
 - (i) fuel for take-off and climb from aerodrome elevation to initial cruising level/altitude, taking into account the expected departure routing; and
 - (ii) fuel from top of climb to top of descent, including any step climb/descent; and
 - (iii) fuel from top of descent to the point where the approach is initiated, taking into account the expected arrival procedure; and
 - (iv) fuel for approach and landing at the destination aerodrome.
- (3) Contingency fuel, except as provided for in Paragraph (b) 'Reduced Contingency Fuel', which shall be the higher of (a)(3)(i) or (a)(3)(ii) below:
 - (i) Either:
 - (A) 5% of the planned trip fuel or, in the event of in-flight re-planning, 5% of the trip fuel for the remainder of the flight; or
 - (B) Not less than 3% of the planned trip fuel or, in the event of in-flight re-planning, 3% of the trip fuel for the remainder of the flight, provided that an en-route alternate aerodrome is available in accordance with Appendix 2 to OPS 1.255; or
 - (C) An amount of fuel sufficient for 20 minutes flying time based upon the planned trip fuel consumption, provided that the operator has established a fuel consumption monitoring programme for individual aeroplanes and uses valid data determined by means of such a programme for fuel calculation; or
 - (D) An amount of fuel based on a statistical method approved by the Authority which ensures an appropriate statistical coverage of the deviation from the planned to the actual trip fuel. This method is used to monitor the fuel consumption on each city pair/aeroplane combination and the operator uses this data for a statistical analysis to calculate contingency fuel for that city pair/aeroplane combination. (See AC OPS 1.255).



- (ii) An amount to fly for 5 minutes at holding speed at 1500 ft (450 m), above the destination aerodrome in Standard Conditions.
- (4) Alternate fuel which shall:
- (i) include;
 - (A) fuel for a missed approach from the applicable MDA/DH at the destination aerodrome to missed approach altitude, taking into account the complete missed approach procedure; and
 - (B) fuel for climb from missed approach altitude to cruising level/altitude, taking into account the expected departure routing; and
 - (C) fuel for cruise from top of climb to top of descent, taking into account the expected routing; and
 - (D) fuel for descent from top of descent to the point where the approach is initiated, taking into account the expected arrival procedure; and
 - (E) fuel for executing an approach and landing at the destination alternate aerodrome selected in accordance with OPS 1.295.
 - (ii) where two destination alternate aerodromes are required in accordance with OPS 1.295(d), be sufficient to proceed to the alternate aerodrome which requires the greater amount of alternate fuel.
- (5) Final reserve fuel, which shall be:
- (i) For aeroplanes with reciprocating engines, fuel to fly for 45 minutes at 1500 ft (450 m) above aerodrome elevation in standard conditions; or
 - (ii) For aeroplanes with turbine engines, fuel to fly for 30 minutes at holding speed at 1500 ft (450 m) above aerodrome elevation in standard conditions, calculated with the estimated mass on arrival at the destination alternate aerodrome or the destination aerodrome, when no destination alternate aerodrome is required.
- (6) The minimum additional fuel, which shall permit:
- (i) The aeroplane to descend as necessary and proceed to an adequate alternate aerodrome in the event of engine failure or loss of pressurisation, whichever requires the greater amount of fuel based on the assumption that such a failure occurs at the most critical point along the route, and
 - (A) hold there for 15 minutes at 1500 ft (450 m) above aerodrome elevation in standard conditions; and
 - (B) make an approach and landing,except that additional fuel is only required if the minimum amount of fuel calculated in accordance with sub-paragraphs (a)(2) to (a)(5) above is not sufficient for such an event, and



- (ii) Holding for 15 minutes at 1500 ft (450 m) above destination aerodrome elevation in standard conditions, when a flight is operated without a destination alternate aerodrome;
- (iii) an aeroplane engaged in EDTO to comply with the EDTO critical fuel scenario as established by the Authority; and (See OPS 1.255)
- (iv) meet additional requirements not covered above.

(7) Extra fuel, which shall be at the discretion of the commander.

(b) Reduced Contingency Fuel (RCF) Procedure

If the operator's fuel policy includes pre-flight planning to a Destination 1 aerodrome (commercial destination) with a reduced contingency fuel procedure using a decision point along the route and a Destination 2 aerodrome (optional refuel destination), the amount of usable fuel, on board for departure, shall be the greater of (b)(1) or (b)(2) below:

(1) The sum of:

- (i) taxi fuel; and
- (ii) trip fuel to the Destination 1 aerodrome, via the decision point; and
- (iii) contingency fuel equal to not less than 5% of the estimated fuel consumption from the decision point to the Destination 1 aerodrome; and
- (iv) alternate fuel or no alternate fuel if the decision point is at less than six hours from the Destination 1 aerodrome and the requirements of OPS 1.295(c)(1)(ii) are fulfilled; and
- (v) final reserve fuel; and
- (vi) additional fuel; and
- (vii) extra fuel if required by the commander.

(2) The sum of:

- (i) taxi fuel; and
- (ii) trip fuel to the Destination 2 aerodrome, via the decision point; and
- (iii) contingency fuel equal to not less than the amount calculated in accordance with subparagraph (a)(3) above from departure aerodrome to the Destination 2 aerodrome; and
- (iv) alternate fuel, if a Destination 2 alternate aerodrome is required; and
- (v) final reserve fuel; and
- (vi) additional fuel; and



(vii) extra fuel if required by the commander.

(c) Pre-Determined Point (PDP) Procedure

If the operator's fuel policy includes planning to a destination alternate aerodrome where the distance between the destination aerodrome and the destination alternate aerodrome is such that a flight can only be routed via a predetermined point to one of these aerodromes, the amount of usable fuel, on board for departure, shall be the greater of (c)(1) or (c)(2) below:

(1) The sum of:

- (i) taxi fuel; and
- (ii) trip fuel from the departure aerodrome to the destination aerodrome, via the predetermined point; and
- (iii) contingency fuel calculated in accordance with sub-paragraph (a)(3) above; and
- (iv) additional fuel if required, but not less than:
 - (A) for aeroplanes with reciprocating engines, fuel to fly for 45 minutes plus 15% of the flight time planned to be spent at cruising level or two hours, whichever is less; or
 - (B) for aeroplanes with turbine engines, fuel to fly for two hours at normal cruise consumption above the destination aerodrome,

This shall not be less than final reserve fuel; and

(v) Extra fuel if required by the commander; or

(2) the sum of:

- (i) taxi fuel; and
- (ii) trip fuel from the departure aerodrome to the destination alternate aerodrome, via the predetermined point; and
- (iii) contingency fuel calculated in accordance with sub-paragraph (a)(3) above; and
- (iv) additional fuel if required, but not less than:
 - (A) for aeroplanes with reciprocating engines, fuel to fly for 45 minutes; or
 - (B) for aeroplanes with turbine engines, fuel to fly for 30 minutes at holding speed at 1500 ft (450 m) above the destination alternate aerodrome elevation in standard conditions;

This shall not be less than final reserve fuel; and

(v) extra fuel if required by the commander.



(d) Isolated Aerodrome Procedure

If the operator's fuel policy includes planning to an isolated aerodrome, the last possible point of diversion to any available en-route alternate aerodrome shall be used as the pre-determined point. See paragraph (c)(1) above.

(e) Notwithstanding the provisions above the Authority may, based on the results of a specific safety risk assessment conducted by the operator which demonstrates how an equivalent level of safety will be maintained, approve variations to the pre-flight fuel calculation of taxi fuel, trip fuel, contingency fuel, destination alternate fuel, and additional fuel. The specific safety risk assessment shall include at least the:

- (1) flight fuel calculations;
- (2) capabilities of the operator to include:
 - (i) a data-driven method that includes a fuel consumption monitoring programme; and/or
 - (ii) the advanced use of alternate aerodromes; and
- (3) specific mitigation measures.



**Appendix 2 to OPS 1.255
Fuel Policy**

(See Appendix 1 to OPS 1.255 (a)(3)(i)(B))
(See OPS 1.192)

Location of the 3% En-Route Alternate (3% ERA) aerodrome for the purpose of reducing contingency fuel to 3%

The 3% ERA aerodrome shall be located within a circle having a radius equal to 20% of the total flight plan distance, the centre of which lies on the planned route at a distance from the destination aerodrome of 25% of the total flight plan distance, or at least 20% of the total flight plan distance plus 50 NM, whichever is greater, all distances are to be calculated in still air conditions (see figure 1).

Figure 1
Location of the 3% En-Route Alternate (3% ERA) aerodrome for the purposes of reducing contingency fuel to 3%

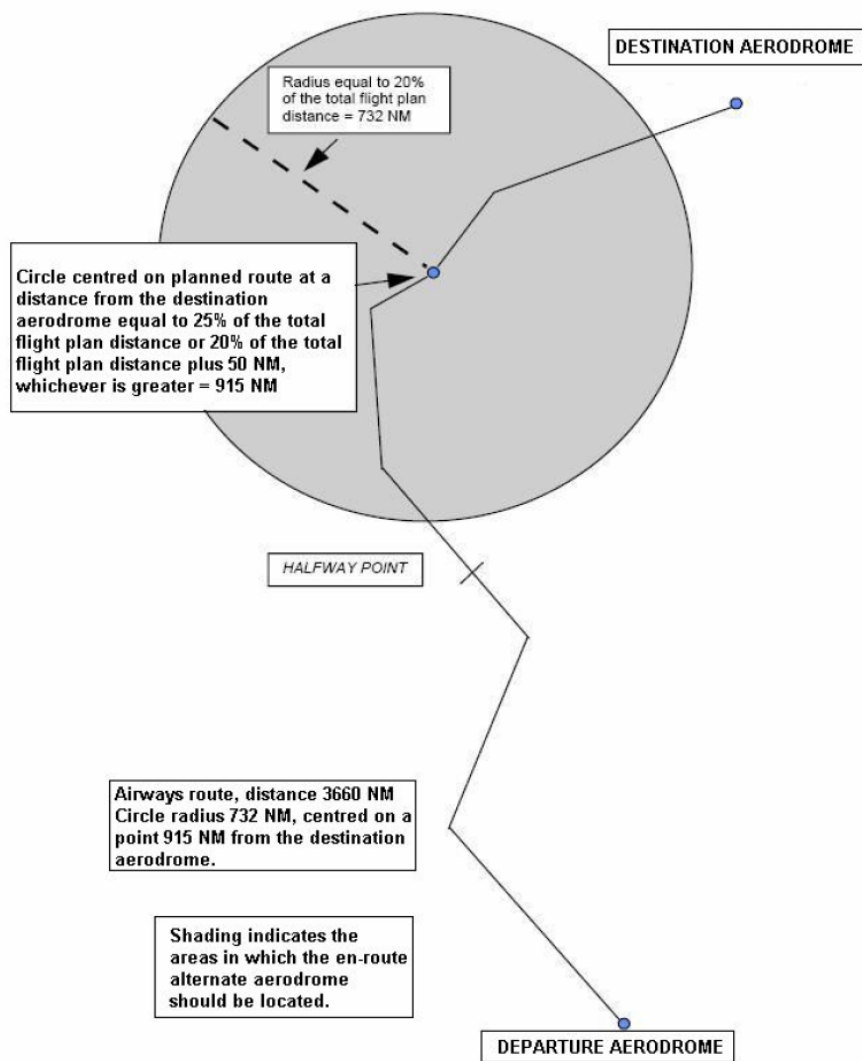



Appendix 1 to OPS 1.270

Stowage of Baggage and Cargo

- (a) Procedures established by the operator to ensure that hand baggage and cargo is adequately and securely stowed must take account of the following:
- (1) Each item carried in a cabin must be stowed only in a location that is capable of restraining it;
 - (2) Mass limitations placarded on or adjacent to stowages must not be exceeded;
 - (3) Under seat stowages must not be used unless the seat is equipped with a restraint bar and the baggage is of such size that it may adequately be restrained by this equipment;
 - (4) Items must not be stowed in toilets or against bulkheads that are incapable of restraining articles against movement forwards, sideways or upwards and unless the bulkheads carry a placard specifying the greatest mass that may be placed there;
 - (5) Baggage and cargo placed in lockers must not be of such size that they prevent latched doors from being closed securely;
 - (6) Baggage and cargo must not be placed where it can impede access to emergency equipment; and
 - (7) Checks must be made before take-off, before landing, and whenever the fasten seat belts signs are illuminated or it is otherwise so ordered to ensure that baggage is stowed where it cannot impede evacuation from the aircraft or cause injury by falling (or other movement) as may be appropriate to the phase of flight.

**Appendix 1 to OPS 1.305****Refuelling/Defueling with Passengers Embarking, on Board or Disembarking**

- (a) The operator must establish operational procedures for re/defueling with passengers embarking, on board or disembarking to ensure the following precautions are taken:
- (1) Qualified personnel must remain at a specified location(s) during re/defuelling operations with passengers on board. These qualified personnel must be capable of initiating and directing an evacuation by the most practical and expeditious means available;
 - (2) Two-way communication shall be established and shall remain available by the aeroplane's inter-communication system or other suitable means between the ground crew supervising the refuelling and the qualified personnel on board the aeroplane;
 - (3) Crew, staff and passengers must be warned that re/defueling will take place;
 - (4) 'Fasten Seat Belts' signs must be off;
 - (5) 'NO SMOKING' signs must be on, together with interior lighting to enable emergency exits to be identified;
 - (6) Passengers must be instructed to unfasten their seat belts and refrain from smoking;
 - (7) Sufficient qualified personnel must be on board and be prepared for an immediate emergency evacuation;
 - (8) If the presence of fuel vapour is detected inside the aeroplane, or any other hazard arises during re/defueling, fuelling must be stopped immediately;
 - (9) The ground area beneath the exits intended for emergency evacuation and slide deployment areas must be kept clear; and
 - (10) Provision is made for a safe and rapid evacuation.

**Appendix 1 to OPS 1.311****Minimum Number of Cabin Crew Required to be on Board an Aeroplane During Ground Operations with Passengers**

When operating under OPS 1.311 the operator shall establish operational procedures to ensure that:

- (a) electrical power is available on the aeroplane;
- (b) means of initiating an evacuation is available to the senior cabin crew member, or at least one member of the flight crew is on the flight deck;
- (c) cabin crew stations and associated duties are specified in the Operations Manual; and
- (d) cabin crew remain aware of the position of servicing and loading vehicles at and near the exits.



SUBPART E

ALL WEATHER OPERATIONS

OPS 1.430 Aerodrome Operating Minima – General

(See Appendix 1 to OPS 1.430)

(See AC OPS 1.430)

- (a) (1) The operator shall establish, for each aerodrome planned to be used, aerodrome operating minima that are not lower than the values given in Appendix 1. The method of determination of such minima must be approved by the Authority and not be lower than any that may be established for such aerodromes by the State of the Aerodrome, except when specifically approved by that State.
- (2) The Authority, as the State of the Operator, shall authorise operational credit(s) for operations with advanced aircraft. Where the operational credit relates to low visibility operations the Authority shall issue a specific approval. Such authorisations shall not affect the classification of the instrument approach procedure.

Note: Operational credit includes:

- (a) *for the purposes of an approach ban under OPS 1.405, or dispatch considerations, a minimum below the aerodrome operating minimum;*
- (b) *reducing or satisfying the visibility requirements; or*
- (c) *requiring fewer ground facilities as compensated for by airborne capabilities.*
- (3) When issuing a specific approval for the operational credit, the Authority, as the State of the Operator shall ensure that;
- (i) the aeroplane meets the appropriate airworthiness certification requirements;
- (ii) the information necessary to support effective crew tasks for the operation is appropriately available to both pilots where the number of flight crew members specified in the operations manual is more than one;
- (iii) the operator has carried out a safety risk assessment of the operations supported by the equipment;
- (iv) the operator has established and documented normal and abnormal procedures and MEL;
- (v) the operator has established a training programme for the flight crew members and relevant personnel involved in the flight preparation;
- (vi) the operator has established a system for data collection, evaluation and trend monitoring for low visibility operations for which there is an operational credit; and
- (vii) the operator has instituted appropriate procedures in respect of continuing airworthiness (maintenance and repair) practices and programmes.



- (4) For operations with operational credit with minima above those related to low visibility operations, the Authority, as the State of the Operator shall establish criteria for the safe operation of the aeroplane.
- (b) The aeroplane categories referred to in this Subpart must be derived in accordance with the method given in Appendix 2 to OPS 1.430(b).
- (c) (1) All approaches shall be flown as stabilised approaches (SAp) unless otherwise approved by the Authority for a particular approach to a particular runway.
- (2) All non-precision approaches shall be flown using the continuous descent final approaches (CDFA) technique unless otherwise approved by the Authority for a particular approach to a particular runway. When calculating the minima in accordance with Appendix 1, the operator shall ensure that the applicable minimum RVR is increased by 200 metres (m) for Cat A/B aeroplanes and by 400 m for Cat C/D aeroplanes for approaches not flown using the CDFA technique, providing that the resulting RVR/CMV value does not exceed 5000 m. (See AC OPS 1.430)
- (3) Notwithstanding the requirements in (c)(2) above, the Authority may exempt the operator from the requirement to increase the RVR when not applying the CDFA technique.
- (4) Exemptions as described in paragraph (c)(3) must be limited to locations where there is a clear public interest to maintain current operations. The exemptions must be based on the operator's experience, training programme and flight crew qualification. The exemptions must be reviewed at regular intervals and must be terminated as soon as facilities are improved to allow application of the CDFA technique.
- (d) (1) The operator must ensure that Appendix 1 to OPS 1.430 is applied.
- (2) Notwithstanding the requirements in (d)(1) above, the Authority may exempt the operator from the requirement to increase the RVR above 1500 m (Cat A/B aeroplanes) or above 2400 m (Cat C/D aeroplanes), when approving an operation to a particular runway where it is not practicable to fly an approach using the CDFA technique or where the criteria in paragraph (c) of Appendix 1 to OPS 1.430 cannot be met.
- (3) Exemptions as described in paragraph (d)(2) must be limited to locations where there is a clear public interest to maintain current operations. The exemptions must be based on the operator's experience, training programme and flight crew qualification. The exemptions must be reviewed at regular intervals and must be terminated as soon as facilities are improved to allow application of the CDFA technique.
- (e) Instrument approach operations shall be classified based on the designed lowest operating minima below which an approach operation shall only be continued with the required visual reference as defined in CAR DEF under "instrument approach procedure".
- (f) The operating minima for 2D instrument approach operations using instrument approach procedures shall be determined by establishing a minimum descent altitude (MDA) or minimum descent height (MDH), minimum visibility and, if necessary, cloud conditions.

Note: For guidance on applying a continuous descent final approach (CDFA) flight technique on non-precision approach procedures, refer to PANS-OPS (Doc 8168), Volume I, Part II, Section 5.



- (g) The operating minima for 3D instrument approach operations using instrument approach procedures shall be determined by establishing a decision altitude (DA) or decision height (DH) and the minimum visibility or RVR.

OPS 1.435 Terminology

- (a) Terms used in this Subpart have the following meaning:
- (1) **Circling.** The visual phase of an instrument approach to bring an aircraft into position for landing on a runway which is not suitably located for a straight-in approach.
 - (2) **Low Visibility Procedures (LVP).** Procedures applied at an aerodrome for the purpose of ensuring safe operations during Other than Standard Category II, Category II and III approaches and low visibility take-offs.
 - (3) **Low Visibility Take-Off (LVTO).** A take-off where the Runway Visual Range (RVR) is less than 400 m.
 - (4) **Flight control system.** A system which includes an automatic landing system and/or a hybrid landing system.
 - (5) **Fail-Passive flight control system.** A flight control system is fail-passive if, in the event of a failure, there is no significant out-of-trim condition or deviation of flight path or attitude but the landing is not completed automatically. For a fail-passive automatic flight control system the pilot assumes control of the aeroplane after a failure.
 - (6) **Fail-Operational flight control system.** A flight control system is fail-operational if, in the event of a failure below alert height, the approach, flare and landing, can be completed automatically. In the event of a failure, the automatic landing system will operate as a fail-passive system.
 - (7) **Fail-operational hybrid landing system.** A system which consists of a primary fail-passive automatic landing system and a secondary independent guidance system enabling the pilot to complete a landing manually after failure of the primary system.
 - (8) **Visual approach.** An approach when either part or all of an instrument approach procedure is not completed and the approach is executed with visual reference to the terrain.
 - (9) **Continuous descent final approach (CDFA).** A specific technique for flying the final-approach segment of a non-precision instrument approach procedure as a continuous descent, without level-off, from an altitude/height at or above the Final Approach Fix altitude/height to a point approximately 15 m (50 feet) above the landing runway threshold or the point where the flare manoeuvre should begin for the type of aeroplane flown.
 - (10) **Stabilised approach (SAp).** An approach which is flown in a controlled and appropriate manner in terms of configuration, energy and control of the flight path from a pre-determined point or altitude/height down to a point 50 feet above the threshold or the point where the flare manoeuvre is initiated if higher.
 - (11) **Head-up display (HUD).** A display system which presents flight information into the pilot's forward external field of view and which does not significantly restrict the external view.



- (12) Head-up guidance landing system (HUDLS). The total airborne system, which provides head-up guidance to the pilot during the approach and landing and/or go-around. It includes all sensors, computers, power supplies, indications and controls. A HUDLS is typically used for primary approach guidance to decision heights of 50 ft.
- (13) Hybrid head-up display landing system (hybrid HUDLS). A system, which consists of a primary fail-passive automatic landing system and a secondary independent HUD/HUDLS, enabling the pilot to complete a landing manually after failure of the primary system.

Note: Typically, the secondary independent HUD/HUDLS provides guidance which normally takes the form of command information, but it may alternatively be situation (or deviation) information.
- (14) Enhanced vision system (EVS). An electronic means of displaying a real-time image of the external scene through the use of imaging sensors.
- (15) Converted meteorological visibility (CMV). A value (equivalent to an RVR) which is derived from the reported meteorological visibility, as converted in accordance with the requirements in this subpart.
- (16) Other than Standard Category II Operation. A Category II Instrument Approach and Landing Operation to a runway where some or all of the elements of the ICAO Annex 14 Precision Approach Category II lighting system are not available.
- (17) GNSS landing system (GLS). An approach operation using augmented GNSS information to provide guidance to the aircraft based on its lateral and vertical GNSS position. (It uses geometric altitude reference for its final approach slope).

OPS 1.440 Low Visibility Operations – General Operating Rules

(See Appendix 1 to OPS 1.440)

- (a) The Authority, as State of the Operator, shall issue a specific approval for instrument approach operations in low visibility, which shall only be conducted when RVR information is provided.
- (b) The operator shall not conduct Category II or Category III operations in low visibility unless:
 - (1) Each aeroplane concerned is certificated for operations with Decision Heights below 200 ft, or no decision height;
 - (2) A suitable system for recording approach and/or automatic landing success and failure is established and maintained to monitor the overall safety of the operation;
 - (3) The operator holds a specific approval from the Authority;
 - (4) The flight crew consists of at least two pilots;
 - (5) Decision Height is determined by means of a radio altimeter; and
 - (6) RVR information is provided.
- (c) For take-off in low visibility, the Authority, as State of the Operator, shall issue a specific approval for the minimum take-off RVR.



- (d) The operator shall not conduct low visibility take-offs in less than 150 m RVR (Category A, B and C aeroplanes) or 200 m RVR (Category D aeroplanes) unless the operator holds a specific approval from the Authority.

OPS 1.445 Low Visibility Operations – Aerodrome Considerations

- (a) The operator shall not use an aerodrome for Category II or III operations unless the aerodrome is approved for such operations by the State in which the aerodrome is located.
- (b) The operator shall verify that Low Visibility Procedures (LVP) have been established, and will be enforced, at those aerodromes where low visibility operations are to be conducted.

OPS 1.450 Low Visibility Operations – Training and Qualifications

(See Appendix 1 to OPS 1.450)

- (a) The operator shall ensure that, prior to conducting low visibility take-off, Other than Standard Category II, Category II and III operations or approaches utilising EVS:
- (1) Each flight crew member:
 - (i) Completes the training and checking requirements prescribed in Appendix 1 including Flight Simulator training in operating to the limiting values of RVR/CMV and Decision Height appropriate to the operator's approval; and
 - (ii) Is qualified in accordance with Appendix 1;
 - (2) The training and checking is conducted in accordance with a detailed syllabus approved by the Authority and included in the Operations Manual. This training is in addition to that prescribed in Subpart N; and
 - (3) The flight crew qualification is specific to the operation and the aeroplane type.

OPS 1.455 Low Visibility Operations – Operating Procedures

(See Appendix 1 to OPS 1.455)

- (a) The operator must establish procedures and instructions to be used for low visibility take-off, approaches utilising EVS, Other than Standard Category II, Category II and III operations. These procedures must be included in the Operations Manual and contain the duties of flight crew members during taxiing, take-off, approach, flare, landing, roll-out and missed approach as appropriate.
- (b) The commander shall satisfy himself/herself that:
- (1) The status of the visual and non-visual facilities is sufficient prior to commencing a low visibility take-off, an approach utilising EVS, Other than Standard Category II, or a Category II or III approach;
 - (2) Appropriate LVPs are in force according to information received from Air Traffic Services, before commencing a low visibility take-off, an Other than Standard Category II, or a Category II or III approach; and



- (3) The flight crew members are properly qualified prior to commencing a low visibility take-off in an RVR of less than 150 m (Category A, B and C aeroplanes) or 200 m (Cat D aeroplanes), an approach utilising EVS, an Other than Standard Category II or a Category II or III approach.

OPS 1.460 Low Visibility Operations – Minimum Equipment

- (a) The operator must include in the Operations Manual the minimum equipment that has to be serviceable at the commencement of a low visibility take-off, an Other than Standard Category II approach, an approach utilising EVS, or a Category II or III approach in accordance with the AFM or other approved document.
- (b) The commander shall satisfy himself/herself that the status of the aeroplane and of the relevant airborne systems is appropriate for the specific operation to be conducted.

OPS 1.465 VFR Operating Minima

- (a) The operator shall ensure that:
 - (1) VFR flights are conducted in accordance with the Visual Flight Rules and in accordance CAR OPS 0.110
 - (2) Special VFR flights are not commenced when the visibility is less than 3 km and not otherwise conducted when the visibility is less than 1.5 km.



Appendix 1 to OPS 1.430
Aerodrome Operating Minima

(See AMC to Appendix 1 to OPS 1.430(e) and (f)
 (See AMC to Appendix 1 to OPS 1.430(f)(4)
 (See AC OPS to Appendix 1 to OPS 1.430(d)
 (See AC OPS to Appendix 1 to OPS 1.430(g)
 (See AC OPS to Appendix 1 to OPS 1.430(i)

(a) *Take-off Minima*

(1) *General*

- (i) Take-off minima established by the operator must be expressed as visibility or RVR limits, taking into account all relevant factors for each aerodrome planned to be used and the aeroplane characteristics. Where there is a specific need to see and avoid obstacles on departure and/or for a forced landing, additional conditions (e.g. ceiling) must be specified.
- (ii) The commander shall not commence take-off unless the weather conditions at the aerodrome of departure are equal to or better than applicable minima for landing at that aerodrome unless a suitable take-off alternate aerodrome is available.
- (iii) When the reported meteorological visibility is below that required for take-off and RVR is not reported, a take-off may only be commenced if the commander can determine that the RVR/visibility along the take-off runway is equal to or better than the required minimum.
- (iv) When no reported meteorological visibility or RVR is available, a take-off may only be commenced if the commander can determine that the RVR/visibility along the take-off runway is equal to or better than the required minimum.

(2) *Visual reference.* The take-off minima must be selected to ensure sufficient guidance to control the aeroplane in the event of both a discontinued take-off in adverse circumstances and a continued take-off after failure of the critical power unit.

(3) *Required RVR/Visibility*

- (i) For multi-engine aeroplanes, whose performance is such that, in the event of a critical power unit failure at any point during take-off, the aeroplane can either stop or continue the take-off to a height of 1500 ft above the aerodrome while clearing obstacles by the required margins, the take-off minima established by the operator must be expressed as RVR/Visibility values not lower than those given in Table 1 below except as provided in paragraph (4).

Table 1 - RVR/Visibility for Take-off

Take-off RVR/Visibility	
Facilities	RVR/Visibility (Note 3)
Nil (Day only)	500 m
Runway edge lighting and/or centreline marking	250/300 m (Notes 1 & 2)



Runway edge and centreline lighting	200/250 m (Note 1)
Runway edge and centreline lighting and multiple RVR information	150/200 m (Notes 1 & 4)

Note 1: The higher values apply to Category D aeroplanes.

Note 2: For night operations at least runway edge and runway end lights are required.

Note 3: The reported RVR/Visibility value representative of the initial part of the take-off run can be replaced by pilot assessment.

Note 4: The required RVR value must be achieved for all of the relevant RVR reporting points with the exception given in Note 3 above.

- (ii) For multi-engine aeroplanes whose performance is such that they cannot comply with the performance conditions in sub-paragraph (a)(3)(i) above in the event of a critical power unit failure, there may be a need to re-land immediately and to see and avoid obstacles in the take-off area. Such aeroplanes may be operated to the following take-off minima provided they are able to comply with the applicable obstacle clearance criteria, assuming engine failure at the height specified. The take-off minima established by the operator must be based upon the height from which the one-engine-inoperative net take-off flight path can be constructed. The RVR minima used may not be lower than either of the values given in Table 1 above or Table 2 below.

Table 2

Assumed engine failure height above the runway versus RVR/Visibility

Take-off RVR/Visibility – flight path	
Assumed engine failure height above the take-off runway	RVR/Visibility (Note 2)
< 50 ft	200 m
51 – 100 ft	300 m
101 – 150 ft	400 m
151 – 200 ft	500 m
201 – 300 ft	1000 m
> 300 ft	1500 m (Note 1)

Note 1: 1500 m is also applicable if no positive take-off flight path can be constructed.

Note 2: The reported RVR/Visibility value representative of the initial part of the take-off run can be replaced by pilot assessment.

- (iii) When reported RVR, or meteorological visibility is not available, the commander shall not commence take-off unless he can determine that the actual conditions satisfy the applicable take-off minima.

(4) *Exceptions to sub-paragraph (a)(3)(i) above:*



- (i) Subject to the approval of the Authority, and provided the requirements in paragraphs (A) to (E) below have been satisfied, the operator may reduce the take-off minima to 125 m RVR (Category A, B and C aeroplanes) or 150 m RVR (Category D aeroplanes) when:
 - (A) Low Visibility Procedures are in force;
 - (B) High intensity runway centreline lights spaced 15 m or less and high intensity edge lights spaced 60 m or less are in operation;
 - (C) Flight crew members have satisfactorily completed training in a Flight Simulator;
 - (D) A 90 m visual segment is available from the cockpit at the start of the take-off run; and
 - (E) The required RVR value has been achieved for all of the relevant RVR reporting points.
 - (ii) Subject to the approval of the Authority, the operator of an aeroplane using either:
 - (A) an approved lateral guidance system; or
 - (B) an approved HUD/HUDLS for take-off may reduce the take-off minima to an RVR less than 125 m (Category A, B and C aeroplanes) or 150 m (Category D aeroplanes) but not lower than 75 m provided runway protection and facilities equivalent to Category III landing operations are available.
- (b) *Category I, APV and Non-Precision approach*
- (1) A Category I approach operation is a precision instrument approach and landing using ILS, MLS, GLS (GNSS/GBAS) or PAR with a decision height not lower than 200 ft and with an RVR not less than 550 m, unless accepted by the Authority.
 - (2) A non-precision approach (NPA) operation is an instrument approach using any of the facilities described in Table 3 (System minima), with a MDH or DH not lower than 250 ft and an RVR/CMV of not less than 750 m, unless accepted by the Authority.
 - (3) An APV operation is an instrument approach which utilises lateral and vertical guidance, but does not meet the requirements established for precision approach and landing operations, with a DH not lower than 250 ft and a runway visual range of not less than 600m unless approved by the Authority.
 - (4) Decision height (DH). the operator must ensure that the decision height to be used for an approach is not lower than:
 - (i) the minimum height to which the approach aid can be used without the required visual reference; or
 - (ii) the OCH for the category of aeroplane; or



- (iii) the published approach procedure decision height where applicable; or
- (iv) 200 ft for Category I approach operations; or
- (v) the system minimum in Table 3; or
- (vi) the lowest decision height specified in the Aeroplane Flight Manual (AFM) or equivalent document, if stated;

whichever is higher.

- (5) Minimum descent height (MDH). the operator must ensure that the minimum descent height for an approach is not lower than:

- (i) the OCH for the category of aeroplane; or
- (ii) the system minimum in Table 3; or
- (iii) the minimum descent height specified in the Aeroplane Flight Manual if stated;

whichever is higher.

- (6) Visual reference. A pilot may not continue an approach below MDA/MDH unless at least one of the following visual references for the intended runway is distinctly visible and identifiable to the pilot:

- (i) elements of the approach light system;
- (ii) the threshold;
- (iii) the threshold markings;
- (iv) the threshold lights;
- (v) the threshold identification lights;
- (vi) the visual glide slope indicator;
- (vii) the touchdown zone or touchdown zone markings;
- (viii) the touchdown zone lights;
- (ix) runway edge lights; or
- (x) other visual references accepted by the Authority.



Table 3

System Minima v. Facilities

System minima	
Facility	Lowest DH (MDH)
ILS/MLS/GLS	200 ft
GNSS/SBAS (LPV)	200 ft
GNSS (LNAV)	250 ft
GNSS/Baro-VNAV (LNAV/VNAV)	250 ft
Localizer with or without DME	250 ft
SRA (terminating at ½ NM)	250 ft
SRA (terminating at 1 NM)	300 ft
SRA (terminating at 2 NM or more)	350 ft
VOR	300 ft
VOR/DME	250 ft
NDB	350 ft
NDB/DME	300 ft
VDF	350 ft

Note: The following abbreviations apply to Table 3.

<i>DME:</i>	<i>distance measuring equipment;</i>
<i>GNSS:</i>	<i>global navigation satellite system;</i>
<i>ILS:</i>	<i>instrument landing system;</i>
<i>LNAV:</i>	<i>lateral navigation;</i>
<i>LOC:</i>	<i>localiser;</i>
<i>LPV:</i>	<i>localiser performance with vertical guidance</i>
<i>SBAS:</i>	<i>satellite-based augmentation system;</i>
<i>SRA:</i>	<i>surveillance radar approach;</i>
<i>VDF:</i>	<i>VHF direction finder;</i>
<i>VNAV:</i>	<i>vertical navigation;</i>
<i>VOR:</i>	<i>VHF omnidirectional radio range.</i>

- (c) Criteria for establishing RVR/Converted Met Visibility (Refer to Table 6)
- (1) In order to qualify for the lowest allowable values of RVR/CMV detailed in Table 6 (applicable to each approach grouping) the instrument approach shall meet at least the following facility requirements and associated conditions:
- (i) Instrument approaches with designated vertical profile up to and including 4,5° for Category A and B aeroplanes, or 3.77° for Category C and D aeroplanes, unless other approach angles are approved by the Authority, where the facilities are:
- (A) ILS/MLS/GLS/PAR; or
- (B) APV; and



where the final approach track is offset by not more than 15° for Category A and B aeroplanes or by not more than 5° for Category C and D aeroplanes.

- (ii) Instrument approaches flown using the CDFA technique with a nominal vertical profile, up to and including 4.5° for Category A and B aeroplanes, or 3.77° for Category C and D aeroplanes, unless other approach angles are approved by the Authority where the facilities are NDB, NDB/DME, VOR, VOR/DME, LLZ, LLZ/DME, VDF, SRA or RNAV/LNAV, with a final-approach segment of at least 3 NM, which also fulfil the following criteria:
 - (A) The final approach track is offset by not more than 15° for Category A and B aeroplanes or by not more than 5° for Category C and D aeroplanes; and
 - (B) The FAF or another appropriate fix where descent is initiated is available, or distance to THR is available by FMS/RNAV or DME; and
 - (C) If the MAPt is determined by timing, the distance from FAF to THR is ≤ 8 NM.
 - (iii) Instrument approaches where the facilities are NDB, NDB/DME, VOR, VOR/DME, LLZ, LLZ/DME, VDF, SRA or RNAV/LNAV, not fulfilling the criteria in paragraph (c)1.(ii) above, or with an MDH $\geq 1\ 200$ ft.
- (2) The missed approach, after an approach has been flown using the CDFA technique, shall be executed when reaching the decision altitude (height) or the MAPt, whichever occurs first. The lateral part of the missed approach procedure must be flown via the MAPt unless otherwise stated on the approach chart.
- (d) Determination of RVR/CMV/Visibility minima for Category I, APV and non-precision approach operations
- (1) The minimum RVR/CMV/Visibility shall be the highest of the values derived from Table 5 or Table 6 but not greater than the maximum values shown in Table 6 where applicable
 - (2) The values in Table 5 are derived from the formula below.

$$\text{Required RVR/visibility (m)} = (\text{DH/MDH (ft)} \times 0.3048) / \tan \alpha - \text{length of approach lights (m)}$$

Note: α is the calculation angle, being a default value of 3.00 degrees increasing in steps
 - (3) With the approval of the Authority, the formula may be used with the actual approach slope and/or the actual length of the approach lights for a particular runway.
 - (4) If the approach is flown with a level flight segment at or above MDA/H, 200 metres shall be added for Cat A and B aeroplane and 400 metres for Cat C and D aeroplane to the minimum RVR/CMV value resulting from the application of Tables 5 and 6.

Note: The added value corresponds to the time/distance required to establish the aeroplane on the final descent.
 - (5) An RVR of less than 750 m as indicated in Table 5 may be used:



- (i) for Category I approach operations to runways with FALS (see below), Runway Touchdown Zone Lights (RTZL) and Runway Centreline Lights (RCLL) provided that the DH is not more than 200 ft; or
 - (ii) for Category I approach operations to runways without RTZL and RCLL when using an approved HUDLS, or equivalent approved system, or when conducting a coupled approach or flight-director-flown approach to a DH equal to or greater than 200 ft. The ILS must not be promulgated as a restricted facility; or
 - (iii) for APV approach operations to runways with FALS, RTZL and RCLL when using an approved HUD.
- (6) The Authority may approve RVR values lower than those given in Table 5, for HUDLS and auto-land operations in accordance with paragraph (e) of this Appendix.
- (7) The visual aids comprise standard runway day markings and approach and runway lighting (runway edge lights, threshold lights, runway end lights and in some cases also touch-down zone and/or runway centre line lights). The approach light configurations acceptable are classified and listed in Table 4 below.
- (8) Notwithstanding the requirements in paragraph (d)(7) above, the authority may approve that RVR values relevant to a Basic Approach Lighting System (BALS) are used on runways where the approach lights are restricted in length below 210m due to terrain or water, but where at least one cross-bar is available.
- (9) For night operations or for any operation where credit for runway and approach lights is required, the lights must be on and serviceable except as provided for in Table 6a.

Table 4

Approach light systems

OPS Class of Facility	Length, configuration and intensity of approach lights
FALS (full approach light system)	ICAO: Precision approach CAT I Lighting System (HIALS 720 m ≥) distance coded centreline, Barrette centreline
IALS (intermediate approach light system)	ICAO: Simple approach lighting system (HIALS 420-719 m) single source, Barrette
BALS (basic approach light system)	Any other approach lighting System (HIALS, MIALS or ALS 210-419 m)
NALS (no approach light system)	Any other approach lighting system (HIALS, MIALS or ALS < 210 m) or no approach lights



Table 5

RVR/CMV (See Table 11) v. DH/MDH

DH or MDH			Class of Lighting Facility			
			FALS	IALS	BALS	NALS
			See paragraphs (d)5, (d)6 and (d)10 about RVR < 750 m			
Feet			Metres			
200	—	210	550	750	1 000	1 200
211	—	220	550	800	1 000	1 200
221	—	230	550	800	1 000	1 200
231	—	240	550	800	1 000	1 200
241	—	250	550	800	1 000	1 300
251	—	260	600	800	1 100	1 300
261	—	280	600	900	1 100	1 300
281	—	300	650	900	1 200	1 400
301	—	320	700	1 000	1 200	1 400
321	—	340	800	1 100	1 300	1 500
341	—	360	900	1 200	1 400	1 600
361	—	380	1 000	1 300	1 500	1 700
381	—	400	1 100	1 400	1 600	1 800
401	—	420	1 200	1 500	1 700	1 900
421	—	440	1 300	1 600	1 800	2 000
441	—	460	1 400	1 700	1 900	2 100
461	—	480	1 500	1 800	2 000	2 200
481	—	500	1 500	1 800	2 100	2 300
501	—	520	1 600	1 900	2 100	2 400
521	—	540	1 700	2 000	2 200	2 400
541	—	560	1 800	2 100	2 300	2 500
561	—	580	1 900	2 200	2 400	2 600
581	—	600	2 000	2 300	2 500	2 700
601	—	620	2 100	2 400	2 600	2 800
621	—	640	2 200	2 500	2 700	2 900
641	—	660	2 300	2 600	2 800	3 000
661	—	680	2 400	2 700	2 900	3 100
681	—	700	2 500	2 800	3 000	3 200
701	—	720	2 600	2 900	3 100	3 300
721	—	740	2 700	3 000	3 200	3 400
741	—	760	2 700	3 000	3 300	3 500
761	—	800	2 900	3 200	3 400	3 600
801	—	850	3 100	3 400	3 600	3 800
851	—	900	3 300	3 600	3 800	4 000
901	—	950	3 600	3 900	4 100	4 300
951	—	1 000	3 800	4 100	4 300	4 500
1 001	—	1 100	4 100	4 400	4 600	4 900
1 101	—	1 200	4 600	4 900	5 000	5 000
1 201 and above			5 000	5 000	5 000	5 000



Table 6

Minimum and maximum applicable RVR/converted met visibility (see Table 11) for all instrument approaches down to CAT I minima (lower and upper cut-off limits):

Facility/conditions	RVR/CMV (m)	Aeroplane category			
		A	B	C	D
I.S, MLS, GLS, PAR and APV	Min	According to Table 5			
	Max	1 500	1 500	2 400	2 400
NDB, NDB/DME, VOR, VOR/DME, LLZ, LLZ/DME, VDF, SRA, RNAV/LNAV with a procedure which fulfils the criteria in paragraph (c)1.(ii):	Min	750	750	750	750
	Max	1 500	1 500	2 400	2 400
For NDB, NDB/DME, VOR, VOR/DME, LLZ, LLZ/DME, VDF, SRA, RNAV/LNAV: — not fulfilling the criteria in paragraph (c)1.(ii) above, or — with a DH or MDH ≥ 1 200 ft	Min	1 000	1 000	1 200	1 200
	Max	According to Table 5 if flown using the CDEFA technique, otherwise an add-on of 200/400 m applies to the values in Table 5 but not to result in a value exceeding 5 000 m.			

Table 6a

Failed or downgraded equipment — effect on landing minima
(See AMC to Appendix 1 to OPS 1.430 Table 6a)

Failed or downgraded equipment (Note 1)	Effect on landing minima				
	CAT IIIB (Note 2)	CAT IIIA	CAT II	CAT I	Non precision
I.S stand-by transmitter	Not allowed		No effect		
Outer Marker	No effect if replaced by published equivalent position				Not applicable
Middle marker	No effect				No effect unless used as MAPT
Touchdown zone RVR assessment system	May be temporarily replaced with midpoint RVR if approved by the State of the aerodrome. RVR may be reported by human observation			No effect	
Midpoint or stop-end RVR	No effect				
Anemometer for runway in use	No effect if other ground source available				
Celiometer	No effect				
Approach lights	Not allowed for operations with DH > 50 ft		Not allowed	minima as for nil facilities	
Approach lights except the last 210 m	No effect		Not allowed	minima as for nil facilities	
Approach lights except the last 420 m	No effect			minima as for intermediate facilities	



Failed or downgraded equipment (Note 1)	Effect on landing minima				
	CAT IIIB (Note 2)	CAT IIIA	CAT II	CAT I	Non precision
Standby power for approach lights	No effect				
Whole runway light system	Not allowed			Day — minima as for nil facilities Night — Not allowed	
Edge lights	Day only; Night — not allowed				
Centreline lights	Day — RVR 300m Night — not allowed		Day — RVR 300 m Night — 550 m	No effect	
Centreline lights spacing increased to 30 m	RVR 150m	No effect			
Touchdown zone lights	Day — RVR 200 m Night — 300 m	Day — RVR 300 m Night — 550 m		No effect	
Standby power for runway lights	Not allowed			No effect	
Taxiway light system	No effect — except delays due to reduced movement rate				

Note 1: Conditions applicable to Table 6a:

- (a) multiple failures of runway lights other than indicated in Table 6a are not acceptable.
- (b) deficiencies of approach and runway lights are treated separately.
- (c) Category II or III operations. A combination of deficiencies in runway lights and RVR assessment equipment is not allowed.
- (d) failures other than ILS affect RVR only and not DH.

Note 2: For CAT IIIB operations with no DH, an operator shall ensure that, for aeroplanes authorised to conduct no DH operations with the lowest RVR limitations, the following applies in addition to the content of Table 6a:

- (a) RVR. At least one RVR value must be available at the aerodrome;
- (b) runway lights
 - (i) no runway edge lights, or no centre lights — Day — RVR 200 m; night — not allowed;
 - (ii) no TDZ lights — no restrictions;
 - (iii) no standby power to runway lights — Day — RVR 200 m; night — not allowed.

(10) Single-pilot operations. For single-pilot operations, the operator must calculate the minimum RVR/visibility for all approaches in accordance with OPS 1.430 and this Appendix.

- (i) An RVR of less than 800 metres as indicated in Table 5 may be used for Category I approaches provided any of the following is used at least down to the applicable DH:
 - (A) a suitable autopilot, coupled to an ILS or MLS which is not promulgated as restricted; or
 - (B) an approved HUDLS (including, where appropriate, EVS), or equivalent approved system.
- (ii) Where RTZL and/or RCLL are not available, the minimum RVR/CMV shall not be less than 600 m.
- (iii) An RVR of less than 800 metres as indicated in Table 5 may be used for APV operations to runways with FALS, RTZL and RCLL when using an approved HUDLS, or equivalent approved system, or when conducting a coupled approach to a DH equal to or greater than 250 ft.



- (e) Precision approach — Category II and Other than Standard Category II operations
- (1) General.
- (i) A Category II operation is a precision instrument approach and landing using ILS or MLS with:
- (A) a decision height below 200 ft but not lower than 100 ft; and
- (B) a runway visual range of not less than 300 m.
- (ii) An Other than Standard Category II operation is a precision instrument approach and landing using ILS or MLS which meets facility requirements as established in paragraph (iii) below with:
- (A) a decision height below 200 ft but not lower than 100 ft; (See Table 7b below) and
- (B) a runway visual range of not less than 350/400 m. (See Table 7b below)
- (iii) The ILS/MLS that supports other than a Standard Category II operation shall be an unrestricted facility with a straight in course ($\leq 3^\circ$ offset) and the ILS shall be certificated to:
- (A) Class I/T/1 for operations down to 450m RVR and to a DH of 200 ft or more; or,
- (B) Class II/D/2 for operations in RVRs of less than 450m or to a DH of less than 200 ft.
- Single ILS facilities are only acceptable if Level 2 performance is provided.
- (2) Decision Height. the operator must ensure that the decision height for:
- (i) Other than Standard Category II and Category II operations is not lower than:
- (A) the minimum decision height specified in the AFM, if stated; or
- (B) the minimum height to which the precision approach aid can be used without the required visual reference; or
- (C) the OCH for the category of aeroplane; or
- (D) the decision height to which the flight crew is authorised to operate; or
- (E) 100 ft;
- whichever is higher.
- (3) Visual reference. A pilot may not continue an approach below either the Category II or the Other than Standard Category II decision height determined in accordance with subparagraph (f)(2) above unless visual reference containing a segment of at least 3 consecutive lights being the centre line of the approach lights, or touchdown zone lights,



or runway centre line lights, or runway edge lights, or a combination of these is attained and can be maintained.

This visual reference must include a lateral element of the ground pattern, i.e. an approach lighting crossbar or the landing threshold or a barrette of the touchdown zone lighting unless the operation is conducted utilising an approved HUDLS to touchdown.

- (4) (i) Required RVR. The lowest minima to be used by the operator for Category II operations are (see table 7a):

Table 7a

RVR for Cat II operations v. DH

Category II minima		
DH(ft)	Auto-coupled/Approved HUDLS to below DH (Note 1a)	
	RVR Aeroplane Category A, B and C	RVR Aeroplane Category D
100-120	300 m	300/350m (Note 2a)
121-140	400 m	400 m
141 and above	450 m	450m

Note 1a: The reference to "auto-coupled to below DH/Approved HUDLS" in this table means continued use of the automatic flight control system or the HUDLS down to a height of 80 % of the DH. Thus airworthiness requirements may, through minimum engagement height for the automatic flight control system, affect the DH to be applied.

Note 2a: 300 m may be used for a Category D aeroplane conducting an auto-land.

- (ii) Required RVR. The lowest minima to be used by the operator for Other than Standard Category II operations are:

Table 7b

Other than Standard Category II Minimum RVR v. approach light system

Other than Standard Category II minima					
DH (ft)	Auto-land or approved HUDLS utilised to touchdown				
	Class of lighting facility				
	FALS	IALS	BALS	NALS	
	See para (d)5., (d)6. and (d)10. about RVR < 750m				
	CAT A-C	CAT D	CAT A-D	CAT A-D	CAT A-D
RVR metres					
100-120	350	400	450	600	700
121-140	400	450	500	600	700
141-160	450	500	500	600	750
161-199	450	500	550	650	750

Note: The visual aids required to conduct other than Standard Category II Operations comprise standard runway day markings and approach and runway lighting (runway edge lights, threshold lights, runway end lights). For operations in RVR of 400 m or less, centre line lights must be available. The approach light configurations are classified and listed in Table 4 above.

- (iii) To conduct Other than Standard Category II operations the operator must ensure that appropriate low visibility procedures are established and in operation at the intended aerodrome of landing.



(f) Precision approach — Category III operations

(1) General. Category III operations are as follows:

(i) Category III A operations. A precision instrument approach and landing using ILS or MLS with:

(A) a decision height lower than 100 ft; and

(B) a runway visual range not less than 200 m.

(ii) Category III B operations. A precision instrument approach and landing using ILS or MLS with:

(A) a decision height lower than 100 ft, or no decision height; and

(B) a runway visual range lower than 200 m but not less than 75 m.

Note: Where the decision height (DH) and runway visual range (RVR) do not fall within the same Category, the RVR will determine in which Category the operation is to be considered.

(iii) Category III C operations. A precision instrument approach and landing using ILS or MLS with:

(A) no decision height; and

(B) no runway visual range limitation.

(2) Decision Height. For operations in which a decision height is used, the operator must ensure that the decision height is not lower than:

(i) the minimum decision height specified in the AFM, if stated; or

(ii) the minimum height to which the precision approach aid can be used without the required visual reference; or

(iii) the decision height to which the flight crew is authorised to operate.

(3) No decision height operations. Operations with no decision height may only be conducted if:

(i) the operation with no decision height is authorised in the AFM; and

(ii) the approach aid and the aerodrome facilities can support operations with no decision height; and

(iii) the operator has an approval for CAT III operations with no decision height.

Note: In the case of a CAT III runway it may be assumed that operations with no decision height can be supported unless specifically restricted as published in the AIP or NOTAM.



- (4) Visual reference.
- (i) For Category III A operations, and conducted either with fail-passive flight control systems, or with the use of an approved HUDLS, a pilot may not continue an approach below the decision height determined in accordance with subparagraph (f)(1)(i) above unless a visual reference containing a segment of at least three consecutive lights being the centreline of the approach lights, or touchdown zone lights, or runway centreline lights, or runway edge lights, or a combination of these is attained and can be maintained.
 - (ii) For Category IIIB operations conducted either with fail-operational flight control systems or with a fail-operational hybrid landing system (comprising e.g. a HUDLS) using a decision height a pilot may not continue an approach below the decision height, determined in accordance with subparagraph (f)(1)(ii) above, unless a visual reference containing at least one centreline light is attained and can be maintained.
 - (iii) Category III C operations. A precision instrument approach and landing using ILS or MLS with:
 - (A) no decision height; and
 - (B) no runway visual range limitation.
- (g) Enhanced vision systems
- (1) A pilot using an enhanced vision system certificated for the purpose of this paragraph and used in accordance with the procedures and limitations of the approved flight manual, may;
 - (i) continue an approach below DH or MDH to 100 feet above the threshold elevation of the runway provided that at least one of the following visual references is displayed and identifiable on the enhanced vision system:
 - (A) elements of the approach lighting; or
 - (B) the runway threshold, identified by at least one of the following: the beginning of the runway landing surface, the threshold lights, the threshold identification lights; and the touchdown zone, identified by at least one of the following: the runway touchdown zone landing surface, the touchdown zone lights, the touchdown zone markings or the runway lights;
 - (iii) reduce the calculated RVR/CMV for the approach from the value in column 1 of Table 9 below to the value in column 2:

Table 9



Approach utilising EVS RVR/CMV reduction v. normal RVR/CMV

RVR/CMV normally required	RVR/CMV for approach utilising EVS
550	350
600	400
650	450
700	450
750	500
800	550
900	600
1 000	650
1 100	750
1 200	800
1 300	900
1 400	900
1 500	1 000
1 600	1 100
1 700	1 100
1 800	1 200
1 900	1 300
2 000	1 300
2 100	1 400
2 200	1 500
2 300	1 500
2 400	1 600
2 500	1 700
2 600	1 700
2 700	1 800
2 800	1 900
2 900	1 900
3 000	2 000
3 100	2 000
3 200	2 100
3 300	2 200
3 400	2 200
3 500	2 300
3 600	2 400
3 700	2 400
3 800	2 500
3 900	2 600
4 000	2 600
4 100	2 700
4 200	2 800
4 300	2 800
4 400	2 900
4 500	3 000
4 600	3 000
4 700	3 100
4 800	3 200
4 900	3 200
5 000	3 300

- (2) Paragraph (h)(1) above may only be used for ILS, MLS, PAR, GLS and APV Operations with a DH no lower than 200 feet or an approach flown using approved vertical flight path guidance to a MDH or DH no lower than 250 feet.
- (3) A pilot may not continue an approach below 100 feet above runway threshold elevation for the intended runway, unless at least one of the visual references specified below is distinctly visible and identifiable to the pilot without reliance on the enhanced vision system:
 - (i) The lights or markings of the threshold; or



- (ii) The lights or markings of the touchdown zone.
- (h) *Intentionally left blank*
- (i) Circling
 - (1) Minimum descent height (MDH). The MDH for circling shall be the higher of;
 - (i) the published circling OCH for the aeroplane category; or
 - (ii) the minimum circling height derived from Table 10 below; or
 - (iii) the DH/MDH of the preceding instrument approach procedure.
 - (2) Minimum descent altitude (MDA). The MDA for circling shall be calculated by adding the published aerodrome elevation to the MDH, as determined by (1) above.
 - (3) Visibility. The minimum visibility for circling shall be the higher of;
 - (i) the circling visibility for the aeroplane category, if published; or
 - (ii) the minimum visibility derived from Table 10 below; or
 - (iii) the RVR/CMV derived from Tables 5 and 6 for the preceding instrument approach procedure.
 - (4) Notwithstanding the requirements in subparagraph (3) above, the Authority may exempt the operator from the requirement to increase the visibility above that derived from Table 10.
 - (5) Exemptions as described in subparagraph (4) must be limited to locations where there is a clear public interest to maintain current operations. The exemptions must be based on the operator’s experience, training programme and flight crew qualification. The exemptions must be reviewed at regular intervals.

Table 10

Minimum visibility and MDH for circling v. aeroplane category

	Aeroplane Category			
	A	B	C	D
MDH (ft)	400	500	600	700
Minimum meteorological visibility (m)	1 500	1 600	2 400	3 600

- (6) Circling with prescribed tracks is an accepted procedure within the meaning of this paragraph.
- (j) Visual approach. the operator shall not use an RVR of less than 800 m for a visual approach.
- (k) Conversion of reported meteorological visibility to RVR/CMV.



- (1) The operator must ensure that a meteorological visibility to RVR/CMV conversion is not used for take-off, for calculating any other required RVR minimum less than 800 m, or when reported RVR is available.

Note: If the RVR is reported as being above the maximum value assessed by the aerodrome operator, e.g. “RVR more than 1500 metres”, it is not considered to be a reported value for the purpose of this paragraph.

- (2) When converting meteorological visibility to RVR in all other circumstances than those in subparagraph (1)(1) above, the operator must ensure that the following Table is used:

Table 11

Conversion of met visibility to RVR/CMV

Lighting elements in operation	RVR/CMV = Reported met. Visibility ×	
	Day	Night
HI approach and runway lighting	1,5	2,0
Any type of lighting installation other than above	1,0	1,5
No lighting	1,0	Not applicable



Appendix 2 to OPS 1.430(b)
Aeroplane Categories – All Weather Operations

(a) *Classification of aeroplanes*

The criteria taken into consideration for the classification of aeroplanes by categories is the indicated airspeed at threshold (V_{AT}) which is equal to the stalling speed (V_{SO}) multiplied by 1.3 or V_{S1G} multiplied by 1.23 in the landing configuration at the maximum certificated landing mass. If both V_{SO} and V_{S1G} are available, the higher resulting V_{AT} shall be used. The aeroplane categories corresponding to V_{AT} values are in the Table below:

Aeroplane Category	V_{AT}
A	Less than 91 kt
B	From 91 to 120 kt
C	From 121 to 140 kt
D	From 141 to 165 kt
E	From 166 to 210 kt

The landing configuration which is to be taken into consideration shall be defined by the operator or by the aeroplane manufacturer.

(b) *Permanent change of category (maximum landing mass)*

- (1) The operator may impose a permanent, lower, landing mass, and use this mass for determining the V_{AT} if approved by the Authority.
- (2) The category defined for a given aeroplane shall be a permanent value and thus independent of the changing conditions of day-to-day operations.

**Appendix 1 to OPS 1.440****Low Visibility Operations – General Operating Rules**

(See AMC to Appendix 1 to OPS 1.440(b))

- (a) *General.* The following procedures apply to the introduction and approval of low visibility operations.
- (b) *Operational Demonstration.* The purpose of the operational demonstration is to determine or validate the use and effectiveness of the applicable aircraft flight guidance systems, including HUDLS if appropriate, training, flight crew procedures, maintenance programme, and manuals applicable to the Category II/III programme being approved.
- (1) At least 30 approaches and landings must be accomplished in operations using the Category II/III systems installed in each aircraft type if the requested DH is 50 ft or higher. If the DH is less than 50 ft, at least 100 approaches and landings will need to be accomplished unless otherwise approved by the Authority.
 - (2) If the operator has different variants of the same type of aircraft utilising the same basic flight control and display systems, or different basic flight control and display systems on the same type of aircraft, the operator must show that the various variants have satisfactory performance, but the operator need not conduct a full operational demonstration for each variant. The Authority may also accept a reduction of the number of approach and landings based on credit given for the experience gained by another operator with an AOC issued in accordance with OPS 1 using the same aeroplane type or variant and procedures.
 - (3) If the number of unsuccessful approaches exceeds 5% of the total (e.g. unsatisfactory landings, system disconnects) the evaluation programme must be extended in steps of at least 10 approaches and landings until the overall failure rate does not exceed 5 %.
- (c) *Data Collection For Operational Demonstrations.* Each applicant must develop a data collection method (e.g. a form to be used by the flight crew) to record approach and landing performance. The resulting data and a summary of the demonstration data shall be made available to the Authority for evaluation.
- (d) *Data Analysis.* Unsatisfactory approaches and/or automatic landings shall be documented and analysed.
- (e) *Continuous Monitoring*
- (1) After obtaining the initial authorisation, the operations must be continuously monitored by the operator to detect any undesirable trends before they become hazardous. Flight crew reports may be used to achieve this.
 - (2) The following information must be retained for a period of 12 months:
 - (i) The total number of approaches, by aeroplane type, where the airborne Category II or III equipment was utilised to make satisfactory, actual or practice, approaches to the applicable Category II or III minima; and
 - (ii) Reports of unsatisfactory approaches and/or automatic landings, by aerodrome and aeroplane registration, in the following categories:



- (A) Airborne equipment faults;
 - (B) Ground facility difficulties;
 - (C) Missed approaches because of ATC instructions; or
 - (D) Other reasons.
- (3) The operator must establish a procedure to monitor the performance of the automatic landing system or HUDLS to touchdown performance, as appropriate, of each aeroplane.
- (f) *Transitional periods*
- (1) *Operators with no previous Category II or III experience*
 - (i) The operator without previous CAT II or III operational experience, applying for a CAT II or CAT III operational approval, should demonstrate to the Authority that it has gained a minimum experience of 6 months of CAT I operations on the aircraft type.
 - (ii) The operator applying for a CAT III operational approval should demonstrate to the Authority that it has already completed 6 months of CAT II or III operations on the aircraft type.
 - (2) *Operators with previous Category II or III experience.*
 - (i) The operator with previous CAT II or CAT III experience, applying for a CAT II or CAT III operational approval with reduced transition periods as set out in (1), should demonstrate to the Authority that it has maintained the experience previously gained on the aircraft type.
 - (ii) The operator approved for CAT II or III operations using auto-coupled approach procedures, with or without auto-land, and subsequently introducing manually flown CAT II or III operations using a HUDLS should provide the operational demonstrations set out in (b) as if it would be a new applicant for a CAT II or CAT III approval.
- (g) *Maintenance of Category II, Category III and LVTO equipment.* Maintenance instructions for the on-board guidance systems must be established by the operator, in liaison with the manufacturer, and included in the operator's aeroplane maintenance programme, which must be approved by the Authority.
- (h) *Eligible Aerodromes and Runways*
- (1) Each aeroplane type/runway combination must be verified by the successful completion of at least one approach and landing in Category II or better conditions, prior to commencing Category III operations.
 - (2) For runways with irregular pre-threshold terrain or other foreseeable or known deficiencies, each aeroplane type/runway combination must be verified by operations in Category I or better conditions, prior to commencing Category II, or Other than Standard Category II or III operations.



- (3) If the operator has different variants of the same type of aeroplane in accordance with sub-paragraph (4) below, utilising the same basic flight control and display systems, or different basic flight control and display systems on the same type of aeroplane in accordance with sub-paragraph (4) below, the operator must show that the variants have satisfactory performance, but the operator need not conduct a full operational demonstration for each variant/runway combination.
- (4) For the purpose of paragraph (h), an aeroplane type or variant of an aeroplane type is deemed to be the same type/variant of aeroplane if that type/variant has the same or similar:
- (i) level of technology, including the:
 - (A) FGS and associated displays and controls;
 - (B) the FMS and level of integration with the FGS;
 - (C) use of HUDLS.
 - (ii) Operational procedures, including:
 - (A) alert height;
 - (B) manual landing/automatic landing;
 - (C) no decision height operations;
 - (D) use of HUD/HUDLS in hybrid operations.
 - (iii) Handling characteristics, including:
 - (A) manual landing from automatic or HUDLS guided approach;
 - (B) manual go-around from automatic approach;
 - (C) automatic/manual roll out.
- (5) Operators using the same aeroplane type/class or variant of a type in accordance with subparagraph (4) above may take credit from each other's experience and records in complying with this paragraph.
- (6) Operators conducting Other than Standard Category II operations shall comply with Appendix 1 to OPS 1.440 — Low Visibility Operations — General Operating Rules applicable to Category II operations.



Appendix 1 to OPS 1.450

Low Visibility Operations – Training & Qualifications

(See AMC to Appendix 1 to OPS 1.450(g)(1))

- (a) *General.* the operator must ensure that flight crew member training programmes for Low Visibility Operations include structured courses of ground, Flight Simulator and/or flight training. the operator may abbreviate the course content as prescribed by sub-paragraphs (2) and (3) below provided the content of the abbreviated course is acceptable to the Authority.
- (1) Flight crew members with no Category II or Category III experience must complete the full training programme prescribed in sub-paragraphs (b), (c) and (d) below.
 - (2) Flight crew members with Category II or Category III experience with a similar type of operation (auto coupled/auto-land, HUDLS/Hybrid HUDLS or EVS) or Category II with manual land if appropriate with another operator may undertake an:
 - (i) abbreviated ground training course if operating a different type/class from that on which the previous Category II or Category III experience was gained;
 - (ii) abbreviated ground, flight simulator and/or flight training course if operating the same type/class and variant of the same type or class on which the previous Category II or Category III experience was gained. The abbreviated course is to include at least the requirements of subparagraphs (d)(1), (d)(2)(i) or (d)(2)(ii) as appropriate and (d)(3)(i). With the approval of the Authority, the operator may reduce the number of approaches/landings required by subparagraph (d)(2)(i) if the type/class or the variant of the type or class has the same or similar:
 - (A) level of technology — flight control/guidance system (FGS); and
 - (B) operational procedures;
 - (C) handling characteristics (See paragraph (4) below) as the previously operated type or class, otherwise the requirement of (d)(2)(i) has to be met in full;
 - (D) use of HUDLS/hybrid HUDLS;
 - (E) use of EVS.
 - (3) Flight crew members with Category II or Category III experience with the operator may undertake an abbreviated ground, flight simulator and/or flight training course. The abbreviated course when changing:
 - (i) aeroplane type/class is to include at least the requirements of subparagraphs (d)(1), (d)(2)(i) or (d)(2)(ii) as appropriate and (d)(3)(i);
 - (ii) to a different variant of aeroplane within the same type or class rating that has the same or similar:
 - (A) level of technology — flight control/guidance system (FGS); and
 - (B) operational procedures — integrity;



- (C) handling characteristics (See paragraph (4) below);
- (D) use of HUDLS/Hybrid HUDLS;
- (E) use of EVS

as the previously operated type or class, then a difference course or familiarisation appropriate to the change of variant fulfils the abbreviated course requirements;

- (iii) to a different variant of aeroplane within the same type or class rating that has a significantly different;
 - (A) level of technology — flight control/guidance system (FGS); and
 - (B) operational procedures — integrity;
 - (C) handling characteristics (See paragraph (4) below);
 - (D) use of HUDLS/Hybrid HUDLS;
 - (E) use of EVS

then the requirements of subparagraphs (d)(1), (d)(2)(i) or (d)(2)(ii) as appropriate and (d)(3)(i) shall be fulfilled. With the approval of the Authority the operator may reduce the number of approaches/landings required by subparagraph (d)(2)(i).

- (4) The operator must ensure when undertaking Category II or Category III operations with different variant(s) of aeroplane within the same type or class rating that the differences and/or similarities of the aeroplanes concerned justify such operations, taking account at least the following:
 - (i) the level of technology, including the;
 - (A) FGS and associated displays and controls;
 - (B) Flight Management System and its integration or not with the FGS;
 - (C) use of HUD/HUDLS with hybrid systems and/or EVS;
 - (ii) operational procedures, including;
 - (A) fail-passive/fail-operational, alert height;
 - (B) manual landing/automatic landing;
 - (C) no decision height operations;
 - (D) use of HUD/HUDLS with hybrid systems;
 - (iii) handling characteristics, including;
 - (A) manual landing from automatic HUDLS and/or EVS guided approach;



- (B) manual go-around from automatic approach;
 - (C) automatic/manual roll out.
- (b) *Ground Training. the operator* must ensure that the initial ground training course for Low Visibility Operations covers at least:
- (1) The characteristics and limitations of the ILS and/or MLS;
 - (2) The characteristics of the visual aids;
 - (3) The characteristics of fog;
 - (4) The operational capabilities and limitations of the particular airborne system to include symbology and EVS characteristics if appropriate;
 - (5) The effects of precipitation, ice accretion, low level wind shear and turbulence;
 - (6) The effect of specific aeroplane malfunctions;
 - (7) The use and limitations of RVR assessment systems;
 - (8) The principles of obstacle clearance requirements;
 - (9) Recognition of and action to be taken in the event of failure of ground equipment;
 - (10) The procedures and precautions to be followed with regard to surface movement during operations when the RVR is 400 m or less and any additional procedures required for take-off in conditions below 150 m (200 m for Category D aeroplanes);
 - (11) The significance of decision heights based upon radio altimeters and the effect of terrain profile in the approach area on radio altimeter readings and on the automatic approach/landing systems;
 - (12) The importance and significance of Alert Height if applicable and the action in the event of any failure above and below the Alert Height;
 - (13) The qualification requirements for pilots to obtain and retain approval to conduct Low Visibility Take-offs and Category II or III operations; and
 - (14) The importance of correct seating and eye position.
- (c) *Flight Simulator training and/or flight training*
- (1) The operator must ensure that Flight Simulator and/or flight training for Low Visibility Operations includes:
 - (i) Checks of satisfactory functioning of equipment, both on the ground and in flight;
 - (ii) Effect on minima caused by changes in the status of ground installations;
 - (iii) Monitoring of;



- (A) automatic flight control systems and autoland status annunciators with emphasis on the action to be taken in the event of failures of such systems; and
 - (B) HUD/HUDLS/EVS guidance status and annunciators as appropriate, to include head down displays.
- (iv) Actions to be taken in the event of failures such as engines, electrical systems, hydraulics or flight control systems;
 - (v) The effect of known unserviceabilities and use of minimum equipment lists;
 - (vi) Operating limitations resulting from airworthiness certification;
 - (vii) Guidance on the visual cues required at decision height together with information on maximum deviation allowed from glidepath or Localizer; and
 - (viii) The importance and significance of Alert Height if applicable and the action in the event of any failure above and below the Alert Height.
- (2) The operator must ensure that each flight crew member is trained to carry out his/her duties and instructed on the coordination required with other crew members. Maximum use should be made of Flight Simulators.
 - (3) Training must be divided into phases covering normal operation with no aeroplane or equipment failures but including all weather conditions which may be encountered and detailed scenarios of aeroplane and equipment failure which could affect Category II or III operations. If the aeroplane system involves the use of hybrid or other special systems (such as HUD/HUDLS or enhanced vision equipment) then flight crew members must practise the use of these systems in normal and abnormal modes during the Flight Simulator phase of training.
 - (4) Incapacitation procedures appropriate to Low Visibility Take-offs and Category II and III operations shall be practised.
 - (5) For aeroplanes with no Flight Simulator available to represent that specific aeroplane operators must ensure that the flight training phase specific to the visual scenarios of Category II operations is conducted in a specifically approved Flight Simulator. Such training must include a minimum of four approaches. The training and procedures that are type-specific shall be practised in the aeroplane.
 - (6) Initial Category II and III training shall include at least the following exercises:
 - (i) Approach using the appropriate flight guidance, autopilots and control systems installed in the aeroplane, to the appropriate decision height and to include transition to visual flight and landing;
 - (ii) Approach with all engines operating using the appropriate flight guidance systems, autopilots, HUDLS and/or EVS and control systems installed in the aeroplane down to the appropriate decision height followed by missed approach; all without external visual reference;



- (iii) Where appropriate, approaches utilising automatic flight systems to provide automatic flare, landing and roll-out; and
 - (iv) Normal operation of the applicable system both with and without acquisition of visual cues at decision height.
- (7) Subsequent phases of training must include at least:
- (i) approaches with engine failure at various stages on the approach;
 - (ii) approaches with critical equipment failures (e.g. electrical systems, autoflight systems, ground and/or airborne ILS/MLS systems and status monitors);
 - (iii) approaches where failures of autoflight equipment and/or HUD/HUDLS/EVS at low level require either;
 - (A) reversion to manual flight to control flare, landing and roll out or missed approach; or
 - (B) reversion to manual flight or a downgraded automatic mode to control missed approaches from, at or below decision height including those which may result in a touchdown on the runway;
 - (iv) Failures of the systems which will result in excessive Localizer and/or glideslope deviation, both above and below decision height, in the minimum visual conditions authorised for the operation. In addition, a continuation to a manual landing must be practised if a head-up display forms a downgraded mode of the automatic system or the head-up display forms the only flare mode; and
 - (v) Failures and procedures specific to aeroplane type or variant.
- (8) The training programme must provide practice in handling faults which require a reversion to higher minima.
- (9) The training programme must include the handling of the aeroplane when, during a fail-passive Category III approach, the fault causes the autopilot to disconnect at or below decision height when the last reported RVR is 300 m or less.
- (10) Where take-offs are conducted in RVRs of 400 m and below, training must be established to cover systems failures and engine failure resulting in continued as well as rejected take-offs.
- (11) The training programme must include, where appropriate, approaches where failures of the HUDLS and/or EVS equipment at low level require either:
- (i) reversion to head down displays to control missed approach; or
 - (ii) reversion to flight with no, or downgraded, HUDLS Guidance to control missed approaches from decision height or below, including those which may result in a touchdown on the runway.



- (12) The operator shall ensure that when undertaking low visibility take-off, Other than Standard Category II, and Category II and III Operations utilising a HUD/HUDLS or hybrid HUD/HUDLS or an EVS, that the training and checking programme includes, where appropriate, the use of the HUD/HUDLS in normal operations during all phases of flight.
- (d) *Conversion Training Requirements to conduct Low Visibility Take-off, Other than Standard Category II, approach utilising EVS and Category II and III Operations.* the operator shall ensure that each flight crew member completes the following Low Visibility Procedures training if converting to a new type/class or variant of aeroplane in which Low Visibility Take-off, Other than Standard category II, Approach utilising EVS with an RVR of 800 m or less and Category II and III Operations will be conducted. The flight crew member experience requirements to undertake an abbreviated course are prescribed in sub-paragraphs (a)(2), (a)(3) and (a)(4), above:
- (1) *Ground Training.* The appropriate requirements prescribed in sub-paragraph (b) above, taking into account the flight crew member's Category II and Category III training and experience.
- (2) *Flight Simulator Training and/or Flight training.*
- (i) A minimum of six (eight for HUDLS with or without EVS) approaches and/or landings in a Flight Simulator. The requirement for eight HUDLS approaches may be reduced to six when conducting Hybrid HUDLS operations. (See sub-paragraph 4.(i) below)
- (ii) Where no Flight Simulator is available to represent that specific aeroplane, a minimum of three (five for HUDLS and/or EVS) approaches including at least one go-around is required on the aeroplane. For Hybrid HUDLS operations a minimum of three approaches is required, including at least one go-around.
- (iii) Appropriate additional training if any special equipment is required such as head-up displays or enhanced vision equipment. When approach operations utilising EVS are conducted with an RVR of less than 800 m, a minimum of five approaches, including at least one go-around is required on the aeroplane.
- (3) *Flight Crew Qualification.* The flight crew qualification requirements are specific to the operator and the type of aeroplane operated.
- (i) The operator must ensure that each flight crew member completes a check before conducting Category II or III operations.
- (ii) The check prescribed in sub-paragraph (i) above may be replaced by successful completion of the Flight Simulator and/or flight training prescribed in sub-paragraph (d)2 above.
- (4) *Line Flying under Supervision (LIFUS).* the operator must ensure that each flight crew member undergoes the following line flying under supervision:
- (i) For Category II when a manual landing or a HUDLS approach to touchdown is required, a minimum of
- (A) three landings from autopilot disconnect;



- (B) four landings with HUDLS used to touchdown;

except that only one manual landing (two using HUDLS to touchdown) is required when the training required in subparagraph (d)(2) above has been carried out in a flight simulator qualified for zero flight time conversion.

- (ii) For Category III, a minimum of two autolands except that
 - (A) only one autoland is required when the training required in subparagraph (d)(2) above has been carried out in a Flight Simulator qualified for zero flight time conversion.
 - (B) no autoland is required during LIFUS when the training required in subparagraph (d)(2) above has been carried out in a flight simulator qualified for zero flight time (ZFT) conversion and the flight crew member successfully completed the ZFT type rating conversion course;
 - (C) the flight crew member, trained and qualified in accordance with paragraph (B) above, is qualified to operate during the conduct of LIFUS to the lowest approved DA(H) and RVR as stipulated in the Operations Manual.
- (iii) For Category III approaches using HUDLS to touchdown a minimum of four approaches.

- (e) Type and command experience.

- (1) Before commencing Category II operations, the following additional requirements are applicable to commanders, or pilots to whom conduct of the flight may be delegated, who are new to the aeroplane type/class:
 - (i) 50 hours or 20 sectors on the type, including line flying under supervision; and
 - (ii) 100 m must be added to the applicable Category II RVR minima when the operation requires a Category II manual landing or use of HUDLS to touchdown until:
 - (A) a total of 100 hours or 40 sectors, including LIFUS has been achieved on the type; or
 - (B) a total of 50 hours or 20 sectors, including LIFUS has been achieved on the type where the flight crew member has been previously qualified for Category II manual landing operations with The operator;
 - (C) for HUDLS operations the sector requirements in paragraphs (e) (1) and (e) (2) (i) shall always be applicable, the hours on type/class does not fulfil the requirement.
- (2) Before commencing Category III operations, the following additional requirements are applicable to commanders, or pilots to whom conduct of the flight may be delegated, who are new to the aeroplane type:
 - (i) 50 hours or 20 sectors on the type, including line flying under supervision; and



- (ii) 100 m must be added to the applicable Category II or Category III RVR minima unless he has previously qualified for Category II or III operations with The operator, until a total of 100 hours or 40 sectors, including line flying under supervision, has been achieved on the type.
 - (3) The Authority may authorise a reduction in the above command experience requirements for flight crew members who have Category II or Category III command experience.
- (f) *Low Visibility Take-Off with RVR less than 150/200 m*
- (1) The operator must ensure that prior to authorisation to conduct take-offs in RVRs below 150 m (below 200 m for Category D aeroplanes) the following training is carried out:
 - (i) Normal take-off in minimum authorised RVR conditions;
 - (ii) Take-off in minimum authorised RVR conditions with an engine failure between V₁ and V₂, or as soon as safety considerations permit; and
 - (iii) Take-off in minimum authorised RVR conditions with an engine failure before V₁ resulting in a rejected take-off.
 - (2) The operator must ensure that the training required by sub-paragraph (1) above is carried out in a Flight Simulator. This training must include the use of any special procedures and equipment. Where no Flight Simulator is available to represent that specific aeroplane, the Authority may approve such training in an aeroplane without the requirement for minimum RVR conditions. (See Appendix 1 to OPS 1.965)
 - (3) The operator must ensure that a flight crew member has completed a check before conducting low visibility take-offs in RVRs of less than 150 m (less than 200 m for Category D aeroplanes) if applicable. The check may only be replaced by successful completion of the Flight Simulator and/or flight training prescribed in sub-paragraph (f)(1) on conversion to an aeroplane type.
- (g) *Recurrent Training and Checking – Low Visibility Operations*
- (1) The operator must ensure that, in conjunction with the normal recurrent training and operator proficiency checks, a pilot's knowledge and ability to perform the tasks associated with the particular category of operation for which he/she is authorised is checked. The required number of approaches within the validity period of the operator proficiency check (as prescribed in OPS 1.965(b)) is to be a minimum of two, (four when HUDLS and/or EVS is utilised to touchdown) one of which must be a landing at the lowest approved RVR; in addition one (two for HUDLS and/or operations utilising EVS) of these approaches may be substituted by an approach and landing in the aeroplane using approved Category II or III procedures. One missed approach shall be flown during the conduct of the operator's proficiency check. If the operator is authorised to conduct take-off with RVR less than 150/200 m, at least one LVTO to the lowest applicable minima shall be flown during the conduct of the operators proficiency check. (See AMC OPS 1.450(g)(1)).
 - (2) For Category III operations the operator must use a Flight Simulator.



- (3) The operator must ensure that, for Category III operations on aeroplanes with a fail-passive flight control system, including HUDLS, a missed approach is completed at least once over the period of three consecutive operator proficiency checks as the result of an autopilot failure at or below decision height when the last reported RVR was 300 m or less.
- (4) The Authority may authorise recurrent training and checking for Category II and LVTO operations in an aeroplane type where no Flight Simulator to represent that specific aeroplane or an acceptable alternate is available.

Note: Recency for LVTO and Category II/III based upon automatic approaches and/or autolands is maintained by the recurrent training and checking as prescribed in this paragraph.

- (h) Additional training requirements for operators conducting Other than Standard Category II Operations.
 - (1) Operators conducting Other than Standard Category II operations shall comply with the requirements of Appendix 1 to OPS 1.450 - low visibility operations - training and qualifications applicable to Category II operations to include the requirements applicable to HUDLS (if appropriate). the operator may combine these additional requirements where appropriate provided that the operational procedures are compatible. During conversion training the total number of approaches required shall not be less than that required to complete Category II training utilising a HUD/HUDLS. During recurrent training and checking the operator may also combine the separate requirements provided the above operational procedure requirement is met, provided that at least one approach using Other than Standard Category II minima is conducted at least once every 18 months.
 - (2) Operators conducting approach operations utilising EVS with RVR of 800 m or less shall comply with the requirements of Appendix 1 to OPS 1.450 - Low Visibility Operations - Training and Qualifications applicable to Category II operations to include the requirements applicable to HUD (if appropriate). the operator may combine these additional requirements where appropriate provided that the operational procedures are compatible. During conversion training the total number of approaches required shall not be less than that required to complete Category II training utilising a HUD. During recurrent training and checking the operator may also combine the separate requirements provided the above operational procedure requirement is met, provided that at least one approach utilising EVS is conducted at least once every 12 months.



Appendix 1 to OPS 1.455 Low Visibility Operations – Operating procedures

(a) *General.* Low Visibility Operations include:

- (1) Manual take-off (with or without electronic guidance systems or HUDLS/Hybrid HUD/HUDLS);
- (2) Auto-coupled approach to below DH, with manual flare, landing and roll-out;
- (3) Approach flown with the use of HUDLS/Hybrid HUD/HUDLS and/or EVS;
- (4) Auto-coupled approach followed by auto-flare, autoland and manual roll-out;
- (5) Auto-coupled approach followed by auto-flare, auto landing and auto roll-out, when the applicable RVR is less than 400m.

Note 1: A hybrid system may be used with any of these modes of operations.

Note 2: Other forms of guidance systems or displays may be certificated and approved.

(b) *Procedures and Operating Instructions*

- (1) The precise nature and scope of procedures and instructions given depend upon the airborne equipment used and the flight deck procedures followed. The operator must clearly define flight crew member duties during take-off, approach, flare, roll-out and missed approach in the Operations Manual. Particular emphasis must be placed on flight crew responsibilities during transition from non-visual conditions to visual conditions, and on the procedures to be used in deteriorating visibility or when failures occur. Special attention must be paid to the distribution of flight deck duties so as to ensure that the workload of the pilot making the decision to land or execute a missed approach enables him/her to devote himself/herself to supervision and the decision making process.
- (2) The operator must specify the detailed operating procedures and instructions in the Operations Manual. The instructions must be compatible with the limitations and mandatory procedures contained in the Aeroplane Flight Manual and cover the following items in particular:
 - (i) Checks for the satisfactory functioning of the aeroplane equipment, both before departure and in flight;
 - (ii) Effect on minima caused by changes in the status of the ground installations and airborne equipment;
 - (iii) Procedures for the take-off, approach, flare, landing, roll-out and missed approach;
 - (iv) Procedures to be followed in the event of failures, warnings to include HUD/HUDLS/EVS and other non-normal situations;
 - (v) The minimum visual reference required;



- (vi) The importance of correct seating and eye position;
- (vii) Action which may be necessary arising from a deterioration of the visual reference;
- (viii) Allocation of crew duties in the carrying out of the procedures according to subparagraphs (i) to (iv) and (vi) above, to allow the commander to devote himself/herself mainly to supervision and decision making;
- (ix) The requirement for all height calls below 200 ft to be based on the radio altimeter and for one pilot to continue to monitor the aeroplane instruments until the landing is completed;
- (x) The requirement for the Localizer Sensitive Area to be protected;
- (xi) The use of information relating to wind velocity, windshear, turbulence, runway contamination and use of multiple RVR assessments;
- (xii) procedures to be used for:
 - (A) Other than Standard Category II;
 - (B) approaches utilising EVS; and
 - (C) practice approaches and landing on runways at which the full Category II or Category III aerodrome procedures are not in force;
- (xiii) Operating limitations resulting from airworthiness certification; and
- (xiv) Information on the maximum deviation allowed from the ILS glide path and/or Localizer.

**SUBPART F****PERFORMANCE GENERAL****OPS 1.470 Applicability**

Aeroplanes shall be operated in accordance with the following comprehensive and detailed code of performance, which is substantially equivalent to the overall level embodied in the ICAO Annex 8 Standards. In addition;

- (a) The operator shall ensure that multi-engine aeroplanes powered by turbo-propeller engines with a maximum approved passenger seating configuration of more than 9 or a maximum take-off mass exceeding 5700 kg, and all multi-engine turbojet powered aeroplanes are operated in accordance with Subpart G (Performance Class A).
- (b) The operator shall ensure that propeller driven aeroplanes with a maximum approved passenger seating configuration of 9 or less, and a maximum take-off mass of 5700 kg or less are operated in accordance with Subpart H (Performance Class B).
- (c) The operator shall ensure that aeroplanes powered by reciprocating engines with a maximum approved passenger seating configuration of more than 9 or a maximum take-off mass exceeding 5700 kg are operated in accordance with Subpart I (Performance Class C).
- (d) Where full compliance with the requirements of the appropriate Subpart cannot be shown due to specific design characteristics (e.g. supersonic aeroplanes, seaplanes or aeroplanes of over 5700 kg maximum certificated take-off that are of types of which the prototype was submitted to the appropriate national authorities for certification before 13 June 1960), the operator shall apply approved performance standards that ensure a level of safety equivalent to that of the appropriate Subpart.

OPS 1.475 General

- (a) The operator shall ensure that the mass of the aeroplane:
 - (1) at the start of the take-off; or
 - (2) in the event of in-flight replanning, at the point from which the revised operational flight plan applies,

is not greater than the mass at which the requirements of the appropriate Subpart can be complied with for the flight to be undertaken, allowing for expected reductions in mass as the flight proceeds, and for such fuel jettisoning as is provided for in the particular requirement.

- (b) The operator shall ensure that the approved performance data contained in the Aeroplane Flight Manual is used to determine compliance with the requirements of the appropriate Subpart, supplemented as necessary with other data acceptable to the Authority as prescribed in the relevant Subpart. When applying the factors prescribed in the appropriate Subpart, account may be taken of any operational factors already incorporated in the Aeroplane Flight Manual performance data to avoid double application of factors. (See AMC OPS 1.475(b) & AC OPS 1.475(b)).



- (c) (1) In applying the requirements of the appropriate Subpart, account shall be taken of all factors that significantly affect the performance of the aeroplane, including but not limited to;
- (i) the mass of the aeroplane,
 - (ii) the operating procedures,
 - (iii) the pressure-altitude appropriate to the elevation of the aerodrome,
 - (iv) the runway slope;
 - (v) the ambient temperature,
 - (vi) the wind, and
 - (vii) surface conditions of the runway at the expected time of use i.e., presence of snow, slush, water, and/or ice for landplanes, water surface condition for seaplanes.
- (c) (2) Such factors shall be taken into account directly as operational parameters or indirectly by means of allowances or margins, which may be provided in the scheduling of performance data or in the comprehensive and detailed code of performance in accordance with which the aeroplane is being operated.
- (d) For performance purposes, a damp runway, other than a grass runway, may be considered to be dry.
- (e) The operator shall take account of charting accuracy when assessing compliance with the take-off requirements of the applicable Subpart.
- (f) The Authority, as the State of Registry, shall take such precautions as are reasonably possible to ensure that the general level of safety contemplated by these provisions is maintained under all expected operating conditions, including those not covered specifically by the provisions of Subparts G, H and I, as applicable.
- (g) For aerodromes located in San Marino, obstacle data shall be provided to enable the operator of large aircraft to develop procedures to comply with take-off obstacle clearance requirements.
- (h) Placards, listings, instrument markings, or combinations thereof, containing those operating limitations prescribed for visual presentation, shall be displayed in the aeroplane.
- (i) An aeroplane shall be operated in compliance with the terms of its certificate of airworthiness and within the approved operating limitations contained in its flight manual.
- (j) A flight shall not be commenced unless the performance information provided in the flight manual, supplemented as necessary with other data acceptable to the Authority, as the State of the Operator, indicates that the provisions of the appropriate Subpart can be complied with for the flight to be undertaken.

OPS 1.480 Terminology

- (a) The following terms used in Subparts F, G, H, I and J have the following meaning:



- (1) *Accelerate-stop distance available (ASDA)*. The length of the take-off run available plus the length of stopway, if such stopway is declared available by the appropriate Authority and is capable of bearing the mass of the aeroplane under the prevailing operating conditions.
 - (2) *Contaminated runway*. A runway is considered to be contaminated when more than 25% of the runway surface area (whether in isolated areas or not) within the required length and width being used is covered by the following:
 - (i) Surface water more than 3 mm (0.125 in) deep, or by slush, or loose snow, equivalent to more than 3 mm (0.125 in) of water;
 - (ii) Snow which has been compressed into a solid mass which resists further compression and will hold together or break into lumps if picked up (compacted snow); or
 - (iii) Ice, including wet ice.
 - (3) *Damp runway*. A runway is considered damp when the surface is not dry, but when the moisture on it does not give it a shiny appearance.
 - (4) *Dry runway*. A dry runway is one which is neither wet nor contaminated, and includes those paved runways which have been specially prepared with grooves or porous pavement and maintained to retain 'effectively dry' braking action even when moisture is present.
 - (5) *Landing distance available (LDA)*. The length of the runway which is declared available by the appropriate Authority and suitable for the ground run of an aeroplane landing.
 - (6) *Maximum approved passenger seating configuration*. The maximum passenger seating capacity of an individual aeroplane, excluding pilot seats or flight deck seats and cabin crew seats as applicable, used by the operator, approved by the Authority and specified in the Operations Manual.
 - (7) *Take-off distance available (TODA)*. The length of the take-off run available plus the length of the clearway available.
 - (8) *Take-off mass*. The take-off mass of the aeroplane shall be taken to be its mass, including everything and everyone carried at the commencement of the take-off run.
 - (9) *Take-off run available (TORA)*. The length of runway which is declared available by the appropriate Authority and suitable for the ground run of an aeroplane taking off.
 - (10) *Wet runway*. A runway is considered wet when the runway surface is covered with water, or equivalent, less than specified in sub-paragraph (a)(2) above or when there is sufficient moisture on the runway surface to cause it to appear reflective, but without significant areas of standing water.
- (b) The terms 'accelerate-stop distance', 'take-off distance', 'take-off run', 'net take-off flight path', 'one-engine-inoperative en-route net flight path' and 'two engines inoperative en-route net flight path' as relating to the aeroplane have their meanings defined in the airworthiness requirements under which the aeroplane was certificated, or as specified by the Authority if it



finds that definition inadequate for showing compliance with the performance operating limitations.

Note: For seaplanes only, reference in the appropriate Subpart to a full stop landing means to a satisfactorily low speed (of approximately 9 km/h (5 kt))

**SUBPART G****PERFORMANCE CLASS A****OPS 1.485 General**

- (a) The operator shall ensure that, for determining compliance with the requirements of this Subpart, the approved performance data in the Aeroplane Flight Manual is supplemented as necessary with other data acceptable to the Authority if the approved performance data in the Aeroplane Flight Manual is insufficient in respect of items such as:
- (1) accounting for reasonably expected adverse operating conditions such as take-off and landing on contaminated runways; and
 - (2) consideration of engine failure in all flight phases.
- (b) The operator shall ensure that, for the wet and contaminated runway case, performance data determined in accordance with the aircraft type certificate is used. (See AMC OPS 1.485(b)).

OPS 1.490 Take-off

- (a) The operator shall ensure that the take-off mass does not exceed the maximum take-off mass specified in the Aeroplane Flight Manual for the pressure altitude and the ambient temperature at the aerodrome at which the take-off is to be made.
- (b) The operator must meet the following requirements when determining the maximum permitted take-off mass:
- (1) The accelerate-stop distance must not exceed the accelerate-stop distance available;
 - (2) The take-off distance must not exceed the take-off distance available, with a clearway distance not exceeding half of the take-off run available;
 - (3) The take-off run must not exceed the take-off run available;
 - (4) Compliance with this paragraph must be shown using a single value of V_1 for the rejected and continued take-off; and
 - (5) On a wet or contaminated runway, the take-off mass must not exceed that permitted for a take-off on a dry runway under the same conditions.
- (c) When showing compliance with sub-paragraph (b) above, the operator must take account of the following:
- (1) The pressure altitude at the aerodrome;
 - (2) The ambient temperature at the aerodrome; and
 - (3) The runway surface condition and the type of runway surface (See AMC OPS 1.490(c)(3));
 - (4) The runway slope in the direction of take-off;



- (5) Not more than 50% of the reported head-wind component or not less than 150% of the reported tailwind component; and
- (6) The loss, if any, of runway length due to alignment of the aeroplane prior to take-off. (See AMC OPS 1.490(c)(6)).

OPS 1.495 Take-off Obstacle Clearance

- (a) The operator shall ensure that the net take-off flight path clears all obstacles by a vertical distance of at least 35 ft or by a horizontal distance of at least 90 m plus $0.125 \times D$, where D is the horizontal distance the aeroplane has travelled from the end of the take-off distance available or the end of the take-off distance if a turn is scheduled before the end of the take-off distance available. For aeroplanes with a wingspan of less than 60 m a horizontal obstacle clearance of half the aeroplane wingspan plus 60 m, plus $0.125 \times D$ may be used. (See AMC OPS 1.495(a)).
- (b) When showing compliance with sub-paragraph (a) above, the operator must take account of the following:
 - (1) The mass of the aeroplane at the commencement of the take-off run;
 - (2) The pressure altitude at the aerodrome;
 - (3) The ambient temperature at the aerodrome; and
 - (4) Not more than 50% of the reported head-wind component or not less than 150% of the reported tailwind component.
- (c) When showing compliance with sub-paragraph (a) above:
 - (1) Track changes shall not be allowed up to the point at which the net take-off flight path has achieved a height equal to one half the wingspan but not less than 50 ft above the elevation of the end of the take-off run available. Thereafter, up to a height of 400 ft it is assumed that the aeroplane is banked by no more than 15° . Above 400 ft height bank angles greater than 15° , but not more than 25° may be scheduled;
 - (2) Any part of the net take-off flight path in which the aeroplane is banked by more than 15° must clear all obstacles within the horizontal distances specified in sub-paragraphs (a), (d) and (e) of this paragraph by a vertical distance of at least 50 ft; and
 - (3) The operator must use special procedures, subject to the approval of the Authority, to apply increased bank angles of not more than 20° between 200 ft and 400 ft, or not more than 30° above 400 ft (See Appendix 1 to OPS 1.495(c)(3)).
 - (4) Adequate allowance must be made for the effect of bank angle on operating speeds and flight path including the distance increments resulting from increased operating speeds. (See AMC OPS 1.495(c)(4)).
- (d) When showing compliance with sub-paragraph (a) above for those cases where the intended flight path does not require track changes of more than 15° , the operator need not consider those obstacles which have a lateral distance greater than:



- (1) 300 m, if the pilot is able to maintain the required navigational accuracy through the obstacle accountability area (See AMC OPS 1.495(d)(1) & (e)(1)); or
 - (2) 600 m, for flights under all other conditions.
- (e) When showing compliance with sub-paragraph (a) above for those cases where the intended flight path does require track changes of more than 15°, the operator need not consider those obstacles which have a lateral distance greater than:
- (1) 600 m, if the pilot is able to maintain the required navigational accuracy through the obstacle accountability area (See AMC OPS 1.495 (d)(1) & (e)(1)); or
 - (2) 900 m for flights under all other conditions.
- (f) The operator shall establish contingency procedures to satisfy the requirements of OPS 1.495 and to provide a safe route, avoiding obstacles, to enable the aeroplane to either comply with the en-route requirements of OPS 1.500, or land at either the aerodrome of departure or at a take-off alternate aerodrome (See AMC OPS 1.495(f)).

OPS 1.500 En-route – One-engine-inoperative

(See AMC OPS 1.500)

- (a) The operator shall ensure that the one-engine-inoperative en-route net flight path data shown in the Aeroplane Flight Manual, appropriate to the meteorological conditions expected for the flight, complies with either sub-paragraph (b) or (c) at all points along the route. The net flight path must have a positive gradient at 1500 ft above the aerodrome where the landing is assumed to be made after engine failure. In meteorological conditions requiring the operation of ice protection systems, the effect of their use on the net flight path must be taken into account.
- (b) The gradient of the net flight path must be positive at least 1000 ft above all terrain and obstructions along the route within 9.3 km (5 NM) on either side of the intended track.
- (c) The net flight path must permit the aeroplane to continue flight from the cruising altitude to an aerodrome where a landing can be made in accordance with OPS 1.515 or OPS 1.520 as appropriate, the net flight path clearing vertically, by at least 2000 ft, all terrain and obstructions along the route within 9.3 km (5 NM) on either side of the intended track in accordance with sub-paragraphs (1) to (4) below:
 - (1) The engine is assumed to fail at the most critical point along the route;
 - (2) Account is taken of the effects of winds on the flight path;
 - (3) Fuel jettisoning is permitted to an extent consistent with reaching the aerodrome with the required fuel reserves, if a safe procedure is used; and
 - (4) The aerodrome where the aeroplane is assumed to land after engine failure must meet the following criteria:
 - (i) The performance requirements at the expected landing mass are met; and
 - (ii) Weather reports or forecasts, or any combination thereof, and field condition reports indicate that a safe landing can be accomplished at the estimated time of landing.



- (d) When showing compliance with OPS 1.500, the operator must increase the width margins of subparagraphs (b) and (c) above to 18.5 km (10 NM) if the navigational accuracy does not meet the 95% containment level.

OPS 1.505 En-route – Aeroplanes with Three or More Engines, Two Engines Inoperative

- (a) The operator shall ensure that at no point along the intended track will an aeroplane having three or more engines be more than 90 minutes, at the all-engines long range cruising speed at standard temperature in still air, away from an aerodrome at which the performance requirements applicable at the expected landing mass are met unless it complies with subparagraphs (b) to (f) below.
- (b) The two engines inoperative en-route net flight path data must permit the aeroplane to continue the flight, in the expected meteorological conditions, from the point where two engines are assumed to fail simultaneously, to an aerodrome at which it is possible to land and come to a complete stop when using the prescribed procedure for a landing with two engines inoperative. The net flight path must clear vertically, by at least 2000 ft all terrain and obstructions along the route within 9.3 km (5 NM) on either side of the intended track. At altitudes and in meteorological conditions requiring ice protection systems to be operable, the effect of their use on the net flight path data must be taken into account. If the navigational accuracy does not meet the 95% containment level, the operator must increase the width margin given above to 18.5 km (10 NM).
- (c) The two engines are assumed to fail at the most critical point of that portion of the route where the aeroplane is more than 90 minutes, at the all engines long range cruising speed at standard temperature in still air, away from an aerodrome at which the performance requirements applicable at the expected landing mass are met.
- (d) The net flight path must have a positive gradient at 1500 ft above the aerodrome where the landing is assumed to be made after the failure of two engines.
- (e) Fuel jettisoning is permitted to an extent consistent with reaching the aerodrome with the required fuel reserves, if a safe procedure is used.
- (f) The expected mass of the aeroplane at the point where the two engines are assumed to fail must not be less than that which would include sufficient fuel to proceed to an aerodrome where the landing is assumed to be made, and to arrive there at least 1500 ft directly over the landing area and thereafter to fly level for 15 minutes.

OPS 1.510 Landing – Destination and Alternate Aerodromes

(See AMC OPS 1.510 and 1.515)

- (a) The operator shall ensure that the landing mass of the aeroplane determined in accordance with OPS 1.475(a) does not exceed the maximum landing mass specified for the altitude and the ambient temperature expected for the estimated time of landing at the destination and alternate aerodrome.
- (b) For instrument approaches with a missed approach gradient greater than 2.5% the operator shall verify that the expected landing mass of the aeroplane allows a missed approach with a climb gradient equal to or greater than the applicable missed approach gradient in the one-engine-inoperative missed approach configuration and speed. The use of an alternative method must be approved by the Authority (see AMC OPS 1.510(b) & (c)).



- (c) For instrument approaches with decision heights below 200 ft, the operator must verify that the expected landing mass of the aeroplane allows a missed approach gradient of climb, with the critical engine failed and with the speed and configuration used for go-around of at least 2·5%, or the published gradient, whichever is the greater. The use of an alternative method must be approved by the Authority (see AMC OPS 1.510(b) and (c)).

OPS 1.515 Landing – Dry Runways

(See AMC OPS 1.510 and 1.515)

- (a) The operator shall ensure that the landing mass of the aeroplane determined in accordance with OPS 1.475(a) for the estimated time of landing at the destination aerodrome and at any alternate aerodrome allows a full stop landing from 50 ft above the threshold:
- (1) For turbo-jet powered aeroplanes, within 60% of the landing distance available; or
 - (2) For turbo-propeller powered aeroplanes, within 70% of the landing distance available;
 - (3) For Steep Approach procedures the Authority may approve the use of landing distance data factored in accordance with sub-paragraphs (a)(1) and (a)(2) above as appropriate, based on a screen height of less than 50 ft, but not less than 35 ft. (See Appendix 1 to OPS 1.515(a)(3).)
 - (4) When showing compliance with sub-paragraphs (a)(1) and (a)(2) above, the Authority may exceptionally approve, when satisfied that there is a need (see Appendix 1), the use of Short Landing Operations in accordance with Appendices 1 and 2 together with any other supplementary conditions that the Authority considers necessary in order to ensure an acceptable level of safety in the particular case.
- (b) When showing compliance with sub-paragraph (a) above, the operator must take account of the following:
- (1) The altitude at the aerodrome;
 - (2) Not more than 50% of the head-wind component or not less than 150% of the tailwind component; and
 - (3) The runway slope in the direction of landing if greater than +/-2%.
- (c) When showing compliance with sub-paragraph (a) above, it must be assumed that:
- (1) The aeroplane will land on the most favourable runway, in still air; and
 - (2) The aeroplane will land on the runway most likely to be assigned considering the probable wind speed and direction and the ground handling characteristics of the aeroplane, and considering other conditions such as landing aids and terrain. (See AMC OPS 1.515(c).)
- (d) If the operator is unable to comply with sub-paragraph (c)(1) above for a destination aerodrome having a single runway where a landing depends upon a specified wind component, an aeroplane may be dispatched if 2 alternate aerodromes are designated which permit full compliance with sub-paragraphs (a), (b) and (c). Before commencing an approach to land at the destination aerodrome the commander must satisfy himself/herself that a landing can be made in full compliance with OPS 1.510 and sub-paragraphs (a) and (b) above.



- (e) If the operator is unable to comply with sub-paragraph (c)(2) above for the destination aerodrome, the aeroplane may be dispatched if an alternate aerodrome is designated which permits full compliance with sub-paragraphs (a), (b) and (c).

OPS 1.520 Landing – Wet and Contaminated Runways

- (a) The operator shall ensure that when the appropriate weather reports or forecasts, or a combination thereof, indicate that the runway at the estimated time of arrival may be wet, the landing distance available is at least 115% of the required landing distance, determined in accordance with OPS 1.515.
- (b) The operator shall ensure that when the appropriate weather reports or forecasts, or a combination thereof, indicate that the runway at the estimated time of arrival may be contaminated, the landing distance available must be at least the landing distance determined in accordance with sub-paragraph (a) above, or at least 115% of the landing distance determined in accordance with the aircraft type certificate contaminated landing distance data, whichever is greater.
- (c) A landing distance on a wet runway shorter than that required by sub-paragraph (a) above, but not less than that required by OPS 1.515(a), may be used if the Aeroplane Flight Manual includes specific additional information about landing distances on wet runways.
- (d) A landing distance on a specially prepared contaminated runway shorter than that required by sub-paragraph (b) above, but not less than that required by OPS 1.515(a), may be used if the Aeroplane Flight Manual includes specific additional information about landing distances on contaminated runways.
- (e) When showing compliance with sub-paragraphs (b), (c) and (d) above, the criteria of OPS 1.515 shall be applied accordingly except that OPS 1.515(a)(1) and (2) shall not be applied to sub-paragraph (b) above.



Appendix 1 to OPS 1.495(c)(3)
Approval of Increased Bank Angles

- (a) For the use of increased bank angles requiring special approval, the following criteria shall be met:
- (1) The Aeroplane Flight Manual must contain approved data for the required increase of operating speed and data to allow the construction of the flight path considering the increased bank angles and speeds.
 - (2) Visual guidance must be available for navigation accuracy.
 - (3) Weather minima and wind limitations must be specified for each runway and approved by the Authority.
 - (4) Training in accordance with OPS 1.975.



Appendix 1 to OPS 1.515(a)(3)
Steep Approach Procedures

- (a) The Authority may approve the application of Steep Approach procedures using glideslope angles of 4.5° or more and with screen heights of less than 50 ft but not less than 35 ft, provided that the following criteria are met:
- (1) The Aeroplane Flight Manual must state the maximum approved glideslope angle, any other limitations, normal, abnormal or emergency procedures for the steep approach as well as amendments to the field length data when using steep approach criteria;
 - (2) A suitable glidepath reference system comprising at least a visual glidepath indicating system must be available at each aerodrome at which steep approach procedures are to be conducted; and
 - (3) Weather minima must be specified and approved for each runway to be used with a steep approach. Consideration must be given to the following:
 - (i) The obstacle situation;
 - (ii) The type of glidepath reference and runway guidance such as visual aids, MLS, 3D-NAV, ILS, LLZ, VOR, NDB;
 - (iii) The minimum visual reference to be required at DH and MDA;
 - (iv) Available airborne equipment;
 - (v) Pilot qualification and special aerodrome familiarisation;
 - (vi) Aeroplane Flight Manual limitations and procedures; and
 - (vii) Missed approach criteria.



Appendix 1 to OPS 1.515(a)(4) Short Landing Operations

- (a) For the purpose of OPS 1.515(a)(4) the distance used for the calculation of the permitted landing mass may consist of the usable length of the declared safe area plus the declared landing distance available. The Authority may approve such operations in accordance with the following criteria:
- (1) *Demonstration of the need for Short Landing Operations.* There must be a clear public interest and operational necessity for the operation, either due to the remoteness of the airport or to physical limitations relating to extending the runway.
 - (2) *Aeroplane and Operational Criteria.*
 - (i) Short landing operation will only be approved for aeroplanes where the vertical distance between the path of the pilot's eye and the path of the lowest part of the wheels, with the aeroplane established on the normal glide path, does not exceed 3 metres;
 - (ii) When establishing aerodrome operating minima the visibility/RVR must not be less than 1.5 km. In addition, wind limitations must be specified in the Operations Manual; and
 - (iii) Minimum pilot experience, training requirements and special aerodrome familiarisation must be specified for such operations in the Operations Manual.
 - (3) It is assumed that the crossing height over the beginning of the usable length of the declared safe area is 50 ft.
 - (4) *Additional criteria.* The Authority may impose such additional conditions as are deemed necessary for a safe operation taking into account the aeroplane type characteristics, orographic characteristics in the approach area, available approach aids and missed approach/baulked landing considerations. Such additional conditions may be, for instance, the requirement for VASI/PAPI – type visual slope indicator system.



Appendix 2 to OPS 1.515(a)(4)
Airfield Criteria for Short Landing Operations

- (a) The use of the safe area must be approved by the airport authority.
- (b) The useable length of the declared safe area under the provisions of OPS 1.515(a)(4), and this Appendix, must not exceed 90 metres.
- (c) The width of the declared safe area shall not be less than twice the runway width or twice the wing span, whichever is the greater, centred on the extended runway centre line.
- (d) The declared safe area must be clear of obstructions or depressions which would endanger an aeroplane undershooting the runway and no mobile object shall be permitted on the declared safety area while the runway is being used for short landing operations.
- (e) The slope of the declared safe area must not exceed 5% upward nor 2% downward in the direction of landing.

**SUBPART H****PERFORMANCE CLASS B****OPS 1.525 General**

- (a) Except under OPS 1.526 or where otherwise approved by the Authority, the operator shall not operate a single-engine aeroplane:
- (1) at night; or
 - (2) in Instrument Meteorological Conditions except under Special Visual Flight Rules.

Note: Limitations on the operation of single-engine aeroplanes, not approved under OPS 1.526, are covered by OPS 1.240(d)(6).

- (b) The operator shall treat two-engine aeroplanes which do not meet the climb requirements of Appendix 1 to OPS 1.525(b) as single-engine aeroplanes.

OPS 1.526 Operations of Single-engine Turbine-powered Aeroplanes at Night and/or in Instrument Meteorological Conditions (IMC)

(See OPS 1.842)

(See AMC OPS 1.526)

(Appendix 2 to OPS 1.940)

- (a) The operator may be approved to conduct operations by single-engine turbine-powered aeroplanes at night and/or in IMC, provided that the airworthiness certification of the aeroplane is appropriate and that the overall level of safety is provided by:
- (b) the reliability of the turbine engine shall be shown to have a power loss rate of less than 1 per 100000 engine hours.

Note 1: Power loss in this context is defined as any loss of power, the cause of which may be traced to faulty engine or engine component design or installation, including design or installation of the fuel ancillary or engine control systems.

Note 2: The operator shall be responsible for engine trend monitoring.

- (c) the operator's maintenance procedures, operating practices, flight dispatch procedures and crew training programmes; and
- (d) equipment as specified in OPS 1.842
- (e) the minimum equipment list shall specify the operating equipment required for night and/or IMC operations, and for day/VMC operations.
- (f) The flight manual shall include limitations, procedures, approval status and other information relevant to operations by single-engine turbine-powered aeroplanes at night and/or in IMC.
- (g) The operator approved for operations by single-engine turbine-powered aeroplanes at night and/or in IMC shall report all significant failures, malfunctions or defects to the Authority for notification to the State of Design.



Note: As part of the trend monitoring system the Authority will review the safety data and monitor the reliability information so as to be able to take any actions necessary to ensure that the intended safety level is achieved. The Authority will notify major events or trends of particular concern to the appropriate Type Certificate Holder and the State of Design.

- (h) Operator route planning shall take account of all relevant information in the assessment of intended routes or areas of operations, including the following:
- (1) the nature of the terrain to be overflown, including the potential for carrying out a safe forced landing in the event of an engine failure or major malfunction;
 - (2) weather information, including seasonal and other adverse meteorological influences that may affect the flight; and
 - (3) other criteria and limitations as specified by the State of the Operator.
- (i) The operator shall identify aerodromes or safe forced landing areas available for use in the event of engine failure, and the position of these shall be programmed into the area navigation system. (See AMC OPS 1.526(i))

Note: A 'safe' forced landing in this context means a landing in an area at which it can reasonably be expected that it will not lead to serious injury or loss of life, even though the aeroplane may incur extensive damage.

OPS 1.530 Take-off

- (a) The operator shall ensure that the take-off mass does not exceed the maximum take-off mass specified in the Aeroplane Flight Manual for the pressure altitude and the ambient temperature at the aerodrome at which the take-off is to be made.
- (b) The operator shall ensure that the unfactored take-off distance, as specified in the Aeroplane Flight Manual does not exceed:
- (1) When multiplied by a factor of 1.25, the take-off run available; or
 - (2) When stopway and/or clearway is available, the following:
 - (i) The take-off run available;
 - (ii) When multiplied by a factor of 1.15, the take-off distance available; and
 - (iii) When multiplied by a factor of 1.3, the accelerate-stop distance available.
- (c) When showing compliance with sub-paragraph (b) above, the operator shall take account of the following:
- (1) The mass of the aeroplane at the commencement of the take-off run;
 - (2) The pressure altitude at the aerodrome;
 - (3) The ambient temperature at the aerodrome;



- (4) The runway surface condition and the type of runway surface (See AMC OPS 1.530(c)(4) & AMC OPS 1.530(c)(4));
- (5) The runway slope in the direction of take-off (See AMC OPS 1.530(c)(5)); and
- (6) Not more than 50% of the reported head-wind component or not less than 150% of the reported tail-wind component.

OPS 1.535 Take-off Obstacle Clearance – Multi-Engine Aeroplanes

(See AMC OPS 1.535)

- (a) The operator shall ensure that the take-off flight path of aeroplanes with two or more engines, determined in accordance with this sub-paragraph, clears all obstacles by a vertical margin of at least 50 ft, or by a horizontal distance of at least 90 m plus $0.125 \times D$, where D is the horizontal distance travelled by the aeroplane from the end of the take-off distance available or the end of the take-off distance if a turn is scheduled before the end of the take-off distance available except as provided in sub-paragraphs (b) and (c) below. For aeroplanes with a wingspan of less than 60 m a horizontal obstacle clearance of half the aeroplane wingspan plus 60 m, plus $0.125 \times D$ may be used. When showing compliance with this sub-paragraph (see AMC OPS 1.535(a) & AMC OPS 1.535(a)) it must be assumed that:
 - (1) The take-off flight path begins at a height of 50 ft above the surface at the end of the take-off distance required by OPS 1.530(b) and ends at a height of 1500 ft above the surface;
 - (2) The aeroplane is not banked before the aeroplane has reached a height of 50 ft above the surface, and that thereafter the angle of bank does not exceed 15° ;
 - (3) Failure of the critical engine occurs at the point on the all engine take-off flight path where visual reference for the purpose of avoiding obstacles is expected to be lost;
 - (4) The gradient of the take-off flight path from 50 ft to the assumed engine failure height is equal to the average all-engine gradient during climb and transition to the en-route configuration, multiplied by a factor of 0.77; and
 - (5) The gradient of the take-off flight path from the height reached in accordance with sub-paragraph (4) above to the end of the take-off flight path is equal to the one-engine-inoperative en-route climb gradient shown in the Aeroplane Flight Manual.
- (b) When showing compliance with sub-paragraph (a) above for those cases where the intended flight path does not require track changes of more than 15° , the operator need not consider those obstacles which have a lateral distance greater than:
 - (1) 300 m, if the flight is conducted under conditions allowing visual course guidance navigation, or if navigational aids are available enabling the pilot to maintain the intended flight path with the same accuracy (See Appendix 1 to OPS 1.535(b)(1) & (c)(1)); or
 - (2) 600 m, for flights under all other conditions.
- (c) When showing compliance with sub-paragraph (a) above for those cases where the intended flight path requires track changes of more than 15° , the operator need not consider those obstacles which have a lateral distance greater than:



- (1) 600 m for flights under conditions allowing visual course guidance navigation (See Appendix 1 to OPS 1.535(b)(1) & (c)(1));
 - (2) 900 m for flights under all other conditions.
- (d) When showing compliance with sub-paragraphs (a), (b) and (c) above, the operator must take account of the following:
- (1) The mass of the aeroplane at the commencement of the take-off run;
 - (2) The pressure altitude at the aerodrome;
 - (3) The ambient temperature at the aerodrome; and
 - (4) Not more than 50% of the reported head-wind component or not less than 150% of the reported tail-wind component.

OPS 1.540 En-Route – Multi-engine Aeroplanes

(See AMC OPS 1.540)

- (a) The operator shall ensure that the aeroplane, in the meteorological conditions expected for the flight, and in the event of the failure of one engine, with the remaining engines operating within the maximum continuous power conditions specified, is capable of continuing flight at or above the relevant minimum altitudes for safe flight stated in the Operations Manual to a point 1000 ft above an aerodrome at which the performance requirements can be met.
- (b) When showing compliance with sub-paragraph (a) above:
- (1) The aeroplane must not be assumed to be flying at an altitude exceeding that at which the rate of climb equals 300 ft per minute with all engines operating within the maximum continuous power conditions specified; and
 - (2) The assumed en-route gradient with one-engine-inoperative shall be the gross gradient of descent or climb, as appropriate, respectively increased by a gradient of 0.5%, or decreased by a gradient of 0.5%.

OPS 1.542 En-Route – Single-engine Aeroplanes

(See AMC OPS 1.542)

- (a) The operator shall ensure that the aeroplane, in the meteorological conditions expected for the flight, and in the event of engine failure, is capable of reaching a place at which a safe forced landing can be made. For landplanes, a place on land is required, unless otherwise approved by the Authority. (See AMC OPS 1.542(a).)
- (b) When showing compliance with sub-paragraph (a) above:
- (1) The aeroplane must not be assumed to be flying, with the engine operating within the maximum continuous power conditions specified, at an altitude exceeding that at which the rate of climb equals 300 ft per minute; and
 - (2) The assumed en-route gradient shall be the gross gradient of descent increased by a gradient of 0.5%.

**OPS 1.545 Landing – Destination and Alternate Aerodromes**

(See AMC OPS 1.545 & 1.550)

The operator shall ensure that the landing mass of the aeroplane determined in accordance with OPS 1.475(a) does not exceed the maximum landing mass specified for the altitude and the ambient temperature expected for the estimated time of landing at the destination and alternate aerodrome.

OPS 1.550 Landing – Dry Runway

(See AMC OPS 1.545 & 1.550)

- (a) The operator shall ensure that the landing mass of the aeroplane determined in accordance with OPS 1.475(a) for the estimated time of landing allows a full stop landing from 50 ft above the threshold within 70% of the landing distance available at the destination aerodrome and at any alternate aerodrome.
- (1) The Authority may approve the use of landing distance data factored in accordance with this paragraph based on a screen height of less than 50 ft, but not less than 35 ft. (See Appendix 1 to OPS 1.550(a).)
 - (2) The Authority may approve Short Landing Operations in accordance with the criteria in Appendix 2 to OPS 1.550(a).
- (b) When showing compliance with sub-paragraph (a) above, the operator shall take account of the following:
- (1) The altitude at the aerodrome;
 - (2) Not more than 50% of the head-wind component or not less than 150% of the tail-wind component.
 - (3) The runway surface condition and the type of runway surface (See AMC OPS 1.550(b)(3)); and
 - (4) The runway slope in the direction of landing (See AMC OPS 1.550(b)(4));
- (c) For dispatching an aeroplane in accordance with sub-paragraph (a) above, it must be assumed that:
- (1) The aeroplane will land on the most favourable runway, in still air; and
 - (2) The aeroplane will land on the runway most likely to be assigned considering the probable wind speed and direction and the ground handling characteristics of the aeroplane, and considering other conditions such as landing aids and terrain. (See AMC OPS 1.550(c).)
- (d) If the operator is unable to comply with sub-paragraph (c)(2) above for the destination aerodrome, the aeroplane may be dispatched if an alternate aerodrome is designated which permits full compliance with sub-paragraphs (a), (b) and (c) above.

**OPS 1.555 Landing – Wet and Contaminated Runways**

- (a) The operator shall ensure that when the appropriate weather reports or forecasts, or a combination thereof, indicate that the runway at the estimated time of arrival may be wet, the landing distance available is equal to or exceeds the required landing distance, determined in accordance with OPS 1.550, multiplied by a factor of 1.15. (See AMC OPS 1.555(a).)
- (b) The operator shall ensure that when the appropriate weather reports or forecasts, or a combination thereof, indicate that the runway at the estimated time of arrival may be contaminated, the landing distance, determined by the aircraft type certificate for these conditions, does not exceed the landing distance available.
- (c) A landing distance on a wet runway shorter than that required by sub-paragraph (a) above, but not less than that required by OPS 1.550(a), may be used if the Aeroplane Flight Manual includes specific additional information about landing distances on wet runways.



Appendix 1 to OPS 1.525(b)
General – Take-off and Landing Climb

(a) Take-off Climb

(1) *All Engines Operating*

- (i) The steady gradient of climb after take-off must be at least 4% with:
- (A) Take-off power on each engine;
 - (B) The landing gear extended except that if the landing gear can be retracted in not more than 7 seconds, it may be assumed to be retracted;
 - (C) The wing flaps in the take-off position(s); and
 - (D) A climb speed not less than the greater of $1.1 V_{MC}$ and $1.2 V_{S1}$.

(2) *One-engine-inoperative*

- (i) The steady gradient of climb at an altitude of 400 ft above the take-off surface must be measurably positive with:
- (A) The critical engine inoperative and its propeller in the minimum drag position;
 - (B) The remaining engine at take-off power;
 - (C) The landing gear retracted;
 - (D) The wing flaps in the take-off position(s); and
 - (E) A climb speed equal to that achieved at 50 ft.
- (ii) The steady gradient of climb must be not less than 0.75% at an altitude of 1500 ft above the take-off surface with:
- (A) The critical engine inoperative and its propeller in the minimum drag position;
 - (B) The remaining engine at not more than maximum continuous power;
 - (C) The landing gear retracted;
 - (D) The wing flaps retracted; and
 - (E) A climb speed not less than $1.2 V_{S1}$.

(b) Landing Climb

(1) *All Engines Operating*

- (i) The steady gradient of climb must be at least 2.5% with:



- (A) Not more than the power or thrust that is available 8 seconds after initiation of movement of the power controls from the minimum flight idle position;
 - (B) The landing gear extended;
 - (C) The wing flaps in the landing position; and
 - (D) A climb speed equal to V_{REF} .
- (2) *One-engine-inoperative*
- (i) The steady gradient of climb must be not less than 0.75% at an altitude of 1500 ft above the landing surface with:
 - (A) The critical engine inoperative and its propeller in the minimum drag position;
 - (B) The remaining engine at not more than maximum continuous power;
 - (C) The landing gear retracted;
 - (D) The wing flaps retracted; and
 - (E) A climb speed not less than $1.2 V_{S1}$.



Appendix 1 to OPS 1.535(b)(1) & (c)(1)
Take-off Flight Path – Visual Course Guidance Navigation

In order to allow visual course guidance navigation, the operator must ensure that the weather conditions prevailing at the time of operation including ceiling and visibility, are such that the obstacle and/or ground reference points can be seen and identified. The Operations Manual must specify, for the aerodrome(s) concerned, the minimum weather conditions which enable the flight crew to continuously determine and maintain the correct flight path with respect to ground reference points, so as to provide a safe clearance with respect to obstructions and terrain as follows:

- (a) The procedure must be well defined with respect to ground reference points so that the track to be flown can be analysed for obstacle clearance requirements;
- (b) The procedure must be within the capabilities of the aeroplane with respect to forward speed, bank angle and wind effects;
- (c) A written and/or pictorial description of the procedure must be provided for crew use; and
- (d) The limiting environmental conditions must be specified (e.g. wind, cloud, visibility, day/night, ambient lighting, obstruction lighting).



Appendix 1 to OPS 1.550(a) Steep Approach Procedures

- (a) The Authority may approve the application of Steep Approach procedures using glideslope angles of 4.5° or more, and with screen heights of less than 50 ft but not less than 35 ft, provided that the following criteria are met:
- (1) The Aeroplane Flight Manual must state the maximum approved glideslope angle, any other limitations, normal, abnormal or emergency procedures for the steep approach as well as amendments to the field length data when using steep approach criteria;
 - (2) A suitable glide path reference system, comprising at least a visual glidepath indicating system, must be available at each aerodrome at which steep approach procedures are to be conducted; and
 - (3) Weather minima must be specified and approved for each runway to be used with a steep approach. Consideration must be given to the following:
 - (i) The obstacle situation;
 - (ii) The type of glidepath reference and runway guidance such as visual aids, MLS, 3D-NAV, ILS, LLZ, VOR, NDB;
 - (iii) The minimum visual reference to be required at DH and MDA;
 - (iv) Available airborne equipment;
 - (v) Pilot qualification and special aerodrome familiarisation;
 - (vi) Aeroplane Flight Manual limitations and procedures; and
 - (vii) Missed approach criteria.



Appendix 2 to OPS 1.550(a)

Short Landing Operations

- (a) For the purpose of OPS 1.550(a)(2), the distance used for the calculation of the permitted landing mass may consist of the usable length of the declared safe area plus the declared landing distance available. The Authority may approve such operations in accordance with the following criteria:
- (1) The use of the declared safe area must be approved by the aerodrome authority;
 - (2) The declared safe area must be clear of obstructions or depressions which would endanger an aeroplane undershooting the runway, and no mobile object shall be permitted on the declared safe area while the runway is being used for short landing operations;
 - (3) The slope of the declared safe area must not exceed 5% upward slope nor 2% downward slope in the direction of landing;
 - (4) The useable length of the declared safe area under the provisions of this Appendix shall not exceed 90 metres;
 - (5) The width of the declared safe area shall not be less than twice the runway width, centred on the extended runway centreline;
 - (6) It is assumed that the crossing height over the beginning of the usable length of the declared safe area shall not be less than 50ft.
 - (7) Weather minima must be specified and approved for each runway to be used and shall not be less than the greater of VFR or non-precision approach minima;
 - (8) Pilot requirements must be specified (OPS 1.975(a)) refers);
 - (9) The Authority may impose such additional conditions as are necessary for safe operation taking into account the aeroplane type characteristics, approach aids and missed approach/balked landing considerations.



This Page Intentionally Left Blank

**SUBPART I****PERFORMANCE CLASS C****OPS 1.560 General**

The operator shall ensure that, for determining compliance with the requirements of this Subpart, the approved performance data in the Aeroplane Flight Manual is supplemented, as necessary, with other data acceptable to the Authority if the approved performance data in the Aeroplane Flight Manual is insufficient.

OPS 1.565 Take-off

- (a) The operator shall ensure that the take-off mass does not exceed the maximum take-off mass specified in the Aeroplane Flight Manual for the pressure altitude and the ambient temperature at the aerodrome at which the take-off is to be made.
- (b) The operator shall ensure that, for aeroplanes which have take-off field length data contained in their Aeroplane Flight Manuals that do not include engine failure accountability, the distance from the start of the take-off roll required by the aeroplane to reach a height of 50 ft above the surface with all engines operating within the maximum take-off power conditions specified, when multiplied by a factor of either:
- (1) 1.33 for aeroplanes having two engines; or
 - (2) 1.25 for aeroplanes having three engines; or
 - (3) 1.18 for aeroplanes having four engines,
- does not exceed the take-off run available at the aerodrome at which the take-off is to be made.
- (c) The operator shall ensure that, for aeroplanes which have take-off field length data contained in their Aeroplane Flight Manuals which accounts for engine failure, the following requirements are met in accordance with the specifications in the Aeroplane Flight Manual:
- (1) The accelerate-stop distance must not exceed the accelerate-stop distance available;
 - (2) The take-off distance must not exceed the take-off distance available, with a clearway distance not exceeding half of the take-off run available;
 - (3) The take-off run must not exceed the take-off run available;
 - (4) Compliance with this paragraph must be shown using a single value of V_1 for the rejected and continued take-off; and
 - (5) On a wet or contaminated runway the take-off mass must not exceed that permitted for a take-off on a dry runway under the same conditions.
- (d) When showing compliance with sub-paragraphs (b) and (c) above, the operator must take account of the following:
- (1) The pressure altitude at the aerodrome;



- (2) The ambient temperature at the aerodrome;
- (3) The runway surface condition and the type of runway surface (see AMC OPS 1.565(d)(3));
- (4) The runway slope in the direction of take-off (see AMC OPS 1.565(d)(4));
- (5) Not more than 50% of the reported head-wind component or not less than 150% of the reported tail-wind component; and
- (6) The loss, if any, of runway length due to alignment of the aeroplane prior to take-off. (See AMC OPS 1.565(d)(6).)

OPS 1.570 Take-off Obstacle Clearance

- (a) The operator shall ensure that the take-off flight path with one-engine-inoperative clears all obstacles by a vertical distance of at least 50 ft plus $0.01 \times D$, or by a horizontal distance of at least 90 m plus $0.125 \times D$, where D is the horizontal distance the aeroplane has travelled from the end of the take-off distance available. For aeroplanes with a wingspan of less than 60 m a horizontal obstacle clearance of half the aeroplane wingspan plus 60 m, plus $0.125 \times D$ may be used.
- (b) The take-off flight path must begin at a height of 50 ft above the surface at the end of the take-off distance required by OPS 1.565(b) or (c) as applicable, and end at a height of 1500 ft above the surface.
- (c) When showing compliance with sub-paragraph (a) above, the operator must take account of the following:
 - (1) The mass of the aeroplane at the commencement of the take-off run;
 - (2) The pressure altitude at the aerodrome;
 - (3) The ambient temperature at the aerodrome; and
 - (4) Not more than 50% of the reported head-wind component or not less than 150% of the reported tail-wind component.
- (d) When showing compliance with sub-paragraph (a) above, track changes shall not be allowed up to that point of the take-off flight path where a height of 50 ft above the surface has been achieved. Thereafter, up to a height of 400 ft it is assumed that the aeroplane is banked by no more than 15° . Above 400 ft height bank angles greater than 15° , but not more than 25° may be scheduled. Adequate allowance must be made for the effect of bank angle on operating speeds and flight path including the distance increments resulting from increased operating speeds. (See AMC OPS 1.570(d).)
- (e) When showing compliance with sub-paragraph (a) above for those cases which do not require track changes of more than 15° , the operator need not consider those obstacles which have a lateral distance greater than:
 - (1) 300 m, if the pilot is able to maintain the required navigational accuracy through the obstacle accountability area (See AMC OPS 1.570(e)(1) & (f)(1)); or
 - (2) 600 m, for flights under all other conditions.



- (f) When showing compliance with sub-paragraph (a) above for those cases which do require track changes of more than 15°, the operator need not consider those obstacles which have a lateral distance greater than:
- (1) 600 m, if the pilot is able to maintain the required navigational accuracy through the obstacle accountability area (See AMC OPS 1.570(e)(1) & (f)(1)); or
 - (2) 900 m for flights under all other conditions.
- (g) The operator shall establish contingency procedures to satisfy the requirements of OPS 1.570 and to provide a safe route, avoiding obstacles, to enable the aeroplane to either comply with the en-route requirements of OPS 1.580, or land at either the aerodrome of departure or at a take-off alternate aerodrome.

OPS 1.575 En-Route – All Engines Operating

- (a) The operator shall ensure that the aeroplane will, in the meteorological conditions expected for the flight, at any point on its route or on any planned diversion there from, be capable of a rate of climb of at least 300 ft per minute with all engines operating within the maximum continuous power conditions specified at:
- (1) The minimum altitudes for safe flight on each stage of the route to be flown or of any planned diversion there from specified in, or calculated from the information contained in, the Operations Manual relating to the aeroplane; and
 - (2) The minimum altitudes necessary for compliance with the conditions prescribed in OPS 1.580 and 1.585, as appropriate.

OPS 1.580 En-Route – One-engine-inoperative

(See AMC OPS 1.580)

- (a) The operator shall ensure that the aeroplane will, in the meteorological conditions expected for the flight, in the event of any one engine becoming inoperative at any point on its route or on any planned diversion there from and with the other engine or engines operating within the maximum continuous power conditions specified, be capable of continuing the flight from the cruising altitude to an aerodrome where a landing can be made in accordance with OPS 1.595 or OPS 1.600 as appropriate, clearing obstacles within 9.3 km (5 NM) either side of the intended track by a vertical interval of at least:
- (1) 1000 ft when the rate of climb is zero or greater; or
 - (2) 2000 ft when the rate of climb is less than zero.
- (b) The flight path shall have a positive slope at an altitude of 450 m (1500 ft) above the aerodrome where the landing is assumed to be made after the failure of one engine.
- (c) For the purpose of this sub-paragraph the available rate of climb of the aeroplane shall be taken to be 150 ft per minute less than the gross rate of climb specified.
- (d) When showing compliance with this paragraph, the operator must increase the width margins of sub-paragraph (a) above to 18.5 km (10 NM) if the navigational accuracy does not meet the 95% containment level.



- (e) Fuel jettisoning is permitted to an extent consistent with reaching the aerodrome with the required fuel reserves, if a safe procedure is used.

OPS 1.585 En-Route – Aeroplanes With Three Or More Engines, Two Engines Inoperative

- (a) The operator shall ensure that, at no point along the intended track, will an aeroplane having three or more engines be more than 90 minutes at the all-engine long range cruising speed at standard temperature in still air, away from an aerodrome at which the performance requirements applicable at the expected landing mass are met unless it complies with sub-paragraphs (b) to (e) below.
- (b) The two-engines inoperative flight path shown must permit the aeroplane to continue the flight, in the expected meteorological conditions, clearing all obstacles within 9·3 km (5 NM) either side of the intended track by a vertical interval of at least 2000 ft, to an aerodrome at which the performance requirements applicable at the expected landing mass are met.
- (c) The two engines are assumed to fail at the most critical point of that portion of the route where the aeroplane is more than 90 minutes, at the all engines long range cruising speed at standard temperature in still air, away from an aerodrome at which the performance requirements applicable at the expected landing mass are met.
- (d) The expected mass of the aeroplane at the point where the two engines are assumed to fail must not be less than that which would include sufficient fuel to proceed to an aerodrome where the landing is assumed to be made, and to arrive there at an altitude of at least 450 m (1500 ft) directly over the landing area and thereafter to fly level for 15 minutes.
- (e) For the purpose of this sub-paragraph the available rate of climb of the aeroplane shall be taken to be 150 ft per minute less than that specified.
- (f) When showing compliance with this paragraph, the operator must increase the width margins of sub-paragraph (a) above to 18·5 km (10 NM) if the navigational accuracy does not meet the 95% containment level.
- (g) Fuel jettisoning is permitted to an extent consistent with reaching the aerodrome with the required fuel reserves, if a safe procedure is used.

OPS 1.590 Landing – Destination and Alternate Aerodromes

(See AMC OPS 1.590 and 1.595)

The operator shall ensure that the landing mass of the aeroplane determined in accordance with OPS 1.475(a) does not exceed the maximum landing mass specified in the Aeroplane Flight Manual for the altitude and, if accounted for in the Aeroplane Flight Manual, the ambient temperature expected for the estimated time of landing at the destination and alternate aerodrome.

OPS 1.595 Landing – Dry Runways

(See AMC OPS 1.590 and 1.595)

- (a) The operator shall ensure that the landing mass of the aeroplane determined in accordance with OPS 1.475(a) for the estimated time of landing allows a full stop landing from 50 ft above the threshold within 70% of the landing distance available at the destination and any alternate aerodrome.



- (b) When showing compliance with sub-paragraph (a) above, the operator must take account of the following:
- (1) The altitude at the aerodrome;
 - (2) Not more than 50% of the head-wind component or not less than 150% of the tail-wind component;
 - (3) The type of runway surface (see AMC OPS 1.595(b)(3)); and
 - (4) The slope of the runway in the direction of landing (See AMC OPS 1.595(b)(4)).
- (c) For dispatching an aeroplane in accordance with sub-paragraph (a) above it must be assumed that:
- (1) The aeroplane will land on the most favourable runway in still air; and
 - (2) The aeroplane will land on the runway most likely to be assigned considering the probable wind speed and direction and the ground handling characteristics of the aeroplane, and considering other conditions such as landing aids and terrain. (See AMC OPS 1.595(c).)
- (d) If the operator is unable to comply with sub-paragraph (c)(2) above for the destination aerodrome, the aeroplane may be dispatched if an alternate aerodrome is designated which permits full compliance with sub-paragraphs (a), (b) and (c).

OPS 1.600 Landing – Wet and Contaminated Runways

- (a) The operator shall ensure that when the appropriate weather reports or forecasts, or a combination thereof, indicate that the runway at the estimated time of arrival may be wet, the landing distance available is equal to or exceeds the required landing distance, determined in accordance with OPS 1.595, multiplied by a factor of 1.15.
- (b) The operator shall ensure that when the appropriate weather reports or forecasts, or a combination thereof, indicate that the runway at the estimated time of arrival may be contaminated, the landing distance determined in accordance with the aircraft type certificate for these conditions, does not exceed the landing distance available.



This Page Intentionally Left Blank

**SUBPART J****MASS AND BALANCE****OPS 1.605 General**

(See Appendix 1 to OPS 1.605)

(See AC OPS 1.605)

- (a) The operator shall ensure that during any phase of operation, the loading, mass and centre of gravity of the aeroplane complies with the limitations specified in the approved Aeroplane Flight Manual, or the Operations Manual if more restrictive.
- (b) The operator must establish the mass and the centre of gravity of any aeroplane by actual weighing prior to initial entry into service and thereafter at intervals of 5 years if individual aeroplane masses are used and 9 years if fleet masses are used. The accumulated effects of modifications and repairs on the mass and balance must be accounted for and properly documented. Furthermore, aeroplanes must be reweighed if the effect of modifications on the mass and balance is not accurately known.
- (c) The operator must determine the mass of all operating items and crew members included in the aeroplane dry operating mass by weighing or by using standard masses. The influence of their position on the aeroplane centre of gravity must be determined.
- (d) The operator must establish the mass of the traffic load, including any ballast, by actual weighing or determine the mass of the traffic load in accordance with standard passenger and baggage masses as specified in OPS 1.620.
- (e) The operator must determine the mass of the fuel load by using the actual density or, if not known, the density calculated in accordance with a method specified in the Operations Manual. (See AMC OPS 1.605(e).)

OPS 1.607 Terminology

- (a) *Dry Operating Mass.* The total mass of the aeroplane ready for a specific type of operation excluding all usable fuel and traffic load. This mass includes items such as:
 - (1) Crew and crew baggage;
 - (2) Catering and removable passenger service equipment; and
 - (3) Potable water and lavatory chemicals.
- (b) *Maximum Zero Fuel Mass.* The maximum permissible mass of an aeroplane with no usable fuel. The mass of the fuel contained in particular tanks must be included in the zero fuel mass when it is explicitly mentioned in the Aeroplane Flight Manual limitations.
- (c) *Maximum Structural Landing Mass.* The maximum permissible total aeroplane mass upon landing under normal circumstances.
- (d) *Maximum Structural Take-off Mass.* The maximum permissible total aeroplane mass at the start of the take-off run.
- (e) *Passenger classification.*



- (1) Adults, male and female, are defined as persons of an age of 12 years and above.
 - (2) Children are defined as persons of an age of two years and above but who are less than 12 years of age.
 - (3) Infants are defined as persons who are less than 2 years of age.
- (f) *Traffic Load*. The total mass of passengers, baggage and cargo, including any non-revenue load.

OPS 1.610 Loading, Mass And Balance

The operator shall specify, in the Operations Manual, the principles and methods involved in the loading and in the mass and balance system that meet the requirements of OPS 1.605. This system must cover all types of intended operations.

OPS 1.615 Mass Values for Crew

- (a) The operator shall use the following mass values to determine the dry operating mass:
- (1) Actual masses including any crew baggage; or
 - (2) Standard masses, including hand baggage, of 85 kg for flight crew members and 75 kg for cabin crew members; or
 - (3) Other standard masses acceptable to the Authority.
- (b) The operator must correct the dry operating mass to account for any additional baggage. The position of this additional baggage must be accounted for when establishing the centre of gravity of the aeroplane.

OPS 1.620 Mass Values for Passengers and Baggage

- (a) The operator shall compute the mass of passengers and checked baggage using either the actual weighed mass of each person and the actual weighed mass of baggage or the standard mass values specified in Tables 1 to 3 below except where the number of passenger seats available is less than 10. In such cases passenger mass may be established by use of a verbal statement by or on behalf of each passenger and adding to it a pre-determined constant to account for hand baggage and clothing (See AMC OPS 1.620(a)). The procedure specifying when to select actual or standard masses and the procedure to be followed when using verbal statements must be included in the Operations Manual.
- (b) If determining the actual mass by weighing, the operator must ensure that passengers' personal belongings and hand baggage are included. Such weighing must be conducted immediately prior to boarding and at an adjacent location.
- (c) If determining the mass of passengers using standard mass values, the standard mass values in Tables 1 and 2 below must be used. The standard masses include hand baggage and the mass of any infant below 2 years of age carried by an adult on one passenger seat. Infants occupying separate passenger seats must be considered as children for the purpose of this sub-paragraph.
- (d) *Mass values for passengers – 20 passenger seats or more*



- (1) Where the total number of passenger seats available on an aeroplane is 20 or more, the standard masses of male and female in Table 1 are applicable. As an alternative, in cases where the total number of passenger seats available is 30 or more, the 'All Adult' mass values in Table 1 are applicable.
- (2) For the purpose of Table 1, holiday charter means a charter flight solely intended as an element of a holiday travel package. The holiday charter mass values apply provided that not more than 5% of passenger seats installed in the aeroplane are used for the non-revenue carriage of certain categories of passengers (See AMC OPS 1.620(d)(2)).

Table 1

Passenger seats:	20 and more		30 and more
	Male	Female	All adult
All flights except holiday charters	88 kg	70 kg	84 kg
Holiday charters	83 kg	69 kg	76 kg
Children	35 kg	35 kg	35 kg

(e) *Mass values for passengers – 19 passenger seats or less.*

- (1) Where the total number of passenger seats available on an aeroplane is 19 or less, the standard masses in Table 2 are applicable.

Table 2

Passenger seats	1 – 5	6 – 9	10 – 19
Male	104 kg	96 kg	92 kg
Female	86 kg	78 kg	74 kg
Children	35 kg	35 kg	35 kg

- (2) On flights where no hand baggage is carried in the cabin or where hand baggage is accounted for separately, 6 kg may be deducted from the above male and female masses. Articles such as an overcoat, an umbrella, a small handbag or purse, reading material or a small camera are not considered as hand baggage for the purpose of this sub-paragraph.

(f) *Mass values for baggage*

- (1) Where the total number of passenger seats available on the aeroplane is 20 or more the standard mass values given in Table 3 are applicable for each piece of checked baggage. For aeroplanes with 19 passenger seats or less, the actual mass of checked baggage, determined by weighing, must be used.
- (2) For the purpose of Table 3:
- (i) Flights within the region means flights whose origin and destination are within the area specified in Appendix 1 to OPS 1.620(f); and



- (ii) Intercontinental flight, other than flights within the European region, means a flight with origin and destination in different continents.

Table 3 – 20 or more passenger seats

Type of flight	Baggage standard mass
Within the EUR region	13 kg
Intercontinental	15 kg
All other	13 kg

- (g) If the operator wishes to use standard mass values other than those contained in Tables 1 to 3 above, he must advise the Authority of his reasons and gain its approval in advance. He must also submit for approval a detailed weighing survey plan and apply the statistical analysis method given in Appendix 1 to OPS 1.620(g). After verification and approval by the Authority of the results of the weighing survey, the revised standard mass values are only applicable to that operator. The revised standard mass values can only be used in circumstances consistent with those under which the survey was conducted. Where revised standard masses exceed those in Tables 1–3, then such higher values must be used. (See AMC OPS 1.620(g).)
- (h) On any flight identified as carrying a significant number of passengers whose masses, including hand baggage, are expected to exceed the standard passenger mass, the operator must determine the actual mass of such passengers by weighing or by adding an adequate mass increment. (See AMC OPS 1.620(h) & (i).)
- (i) If standard mass values for checked baggage are used and a significant number of passengers check in baggage that is expected to exceed the standard baggage mass, the operator must determine the actual mass of such baggage by weighing or by adding an adequate mass increment. (See AMC OPS 1.620(h) & (i).)
- (j) The operator shall ensure that a commander is advised when a non-standard method has been used for determining the mass of the load and that this method is stated in the mass and balance documentation.

OPS 1.625 Mass and Balance Documentation

(See Appendix 1 to OPS 1.625)

- (a) The operator shall establish mass and balance documentation prior to each flight specifying the load and its distribution. The mass and balance documentation must enable the commander to determine that the load and its distribution is such that the mass and balance limits of the aeroplane are not exceeded. The person preparing the mass and balance documentation must be named on the document. The person supervising the loading of the aeroplane must confirm by signature that the load and its distribution are in accordance with the mass and balance documentation. This document must be acceptable to the commander, his acceptance being indicated by countersignature or equivalent. (See also OPS 1.1055(a)(12).)
- (b) The operator must specify procedures for Last Minute Changes to the load.
- (c) Subject to the approval of the Authority, the operator may use an alternative to the procedures required by paragraphs (a) and (b) above.



Appendix 1 to OPS 1.605
Mass and Balance – General
(See OPS 1.605)

- (a) *Determination of the dry operating mass of an aeroplane*
- (1) *Weighing of an aeroplane*
- (i) New aeroplanes are normally weighed at the factory and are eligible to be placed into operation without reweighing if the mass and balance records have been adjusted for alterations or modifications to the aeroplane. Aeroplanes transferred from one operator with an approved mass control programme to a San Marino operator with an approved programme need not be weighed prior to use by the receiving operator unless more than 5 years have elapsed since the last weighing.
- (ii) The individual mass and centre of gravity (CG) position of each aeroplane shall be re-established periodically. The maximum interval between two weighings must be defined by the operator and must meet the requirements of OPS 1.605(b). In addition, the mass and the CG of each aeroplane shall be re-established either by;
- (A) weighing; or
- (B) calculation, if the operator is able to provide the necessary justification to prove the validity of the method of calculation chosen, whenever the cumulative changes to the dry operating mass exceed $\pm 0.5\%$ of the maximum landing mass or the cumulative change in CG position exceeds 0.5% of the mean aerodynamic chord.
- (2) *Fleet mass and CG position*
- (i) For a fleet or group of aeroplanes of the same model and configuration, an average dry operating mass and CG position may be used as the fleet mass and CG position, provided that the dry operating masses and CG positions of the individual aeroplanes meet the tolerances specified in sub-paragraph (ii) below. Furthermore, the criteria specified in sub-paragraphs (iii), (iv) and (a)(3) below are applicable.
- (ii) *Tolerances*
- (A) If the dry operating mass of any aeroplane weighed, or the calculated dry operating mass of any aeroplane of a fleet, varies by more than $\pm 0.5\%$ of the maximum structural landing mass from the established dry operating fleet mass or the CG position varies by more than $\pm 0.5\%$ of the mean aero-dynamic chord from the fleet CG, that aeroplane shall be omitted from that fleet. Separate fleets may be established, each with differing fleet mean masses.
- (B) In cases where the aeroplane mass is within the dry operating fleet mass tolerance but its CG position falls outside the permitted fleet tolerance, the aeroplane may still be operated under the applicable dry operating fleet mass but with an individual CG position.



- (C) If an individual aeroplane has, when compared with other aeroplanes of the fleet, a physical, accurately accountable difference (e.g. galley or seat con-figuration), that causes exceedance of the fleet tolerances, this aeroplane may be maintained in the fleet provided that appropriate corrections are applied to the mass and/or CG position for that aeroplane.
 - (D) Aeroplanes for which no mean aerodynamic chord has been published must be operated with their individual mass and CG position values or must be subjected to a special study and approval.
- (iii) *Use of fleet values*
- (A) After the weighing of an aeroplane, or if any change occurs in the aeroplane equipment or configuration, the operator must verify that this aeroplane falls within the tolerances specified in sub-paragraph (2)(ii) above.
 - (B) Aeroplanes which have not been weighed since the last fleet mass evaluation can still be kept in a fleet operated with fleet values, provided that the individual values are revised by computation and stay within the tolerances defined in sub-paragraph (2)(ii) above. If these individual values no longer fall within the permitted tolerances, the operator must either determine new fleet values fulfilling the conditions of sub-paragraphs (2)(i) and (2)(ii) above, or operate the aeroplanes not falling within the limits with their individual values.
 - (C) To add an aeroplane to a fleet operated with fleet values, the operator must verify by weighing or computation that its actual values fall within the tolerances specified in sub-paragraph (2)(ii) above.
- (iv) To comply with sub-paragraph (2)(i) above, the fleet values must be updated at least at the end of each fleet mass evaluation.

(3) *Number of aeroplanes to be weighed to obtain fleet values*

- (i) If ‘n’ is the number of aeroplanes in the fleet using fleet values, the operator must at least weigh, in the period between two fleet mass evaluations, a certain number of aeroplanes defined in the Table below:

Number of aeroplanes in the fleet	Minimum number of weighings
2 or 3	n
4 to 9	n + 3 2
10 or more	n + 51 10

- (ii) In choosing the aeroplanes to be weighed, aeroplanes in the fleet which have not been weighed for the longest time shall be selected.
- (iii) The interval between two fleet mass evaluations must not exceed 48 months.



- (4) *Weighing procedure*
- (i) The weighing must be accomplished either by the manufacturer or by an approved maintenance organisation.
 - (ii) Normal precautions must be taken consistent with good practices such as:
 - (A) Checking for completeness of the aeroplane and equipment;
 - (B) Determining that fluids are properly accounted for;
 - (C) Ensuring that the aeroplane is clean; and
 - (D) Ensuring that weighing is accomplished in an enclosed building.
 - (iii) Any equipment used for weighing must be properly calibrated, zeroed, and used in accordance with the manufacturer's instructions. Each scale must be calibrated either by the manufacturer, by a civil department of weights and measures or by an appropriately authorised organisation within 2 years or within a time period defined by the manufacturer of the weighing equipment, whichever is less. The equipment must enable the mass of the aeroplane to be established accurately. (See AMC to Appendix 1 to OPS 1.605(a)(4)(iii)).
- (b) *Special standard masses for the traffic load.* In addition to standard masses for passengers and checked baggage, the operator can submit for approval to the Authority standard masses for other load items.
- (c) *Aeroplane loading*
- (1) The operator must ensure that the loading of its aeroplanes is performed under the supervision of qualified personnel.
 - (2) The operator must ensure that the loading of the freight is consistent with the data used for the calculation of the aeroplane mass and balance.
 - (3) The operator must comply with additional structural limits such as the floor strength limitations, the maximum load per running metre, the maximum mass per cargo compartment, and/or the maximum seating limits.
- (d) *Centre of gravity limits*
- (1) *Operational CG envelope.* Unless seat allocation is applied and the effects of the number of passengers per seat row, of cargo in individual cargo compartments and of fuel in individual tanks is accounted for accurately in the balance calculation, operational margins must be applied to the certificated centre of gravity envelope. In determining the CG margins, possible deviations from the assumed load distribution must be considered. If free seating is applied, the operator must introduce procedures to ensure corrective action by flight or cabin crew if extreme longitudinal seat selection occurs. The CG margins and associated operational procedures, including assumptions with regard to passenger seating, must be acceptable to the Authority. (See AMC to Appendix 1 to OPS 1.605 subparagraph (d).)



- (2) *In-flight centre of gravity.* Further to sub-paragraph (d)(1) above, the operator must show that the procedures fully account for the extreme variation in CG travel during flight caused by passenger/crew movement and fuel consumption/transfer.



Appendix 1 to OPS 1.620(f) Definition of the Area for Flights within the Region

For the purposes of OPS 1.620(f), “flights within the European region” are flights conducted within the area bounded by rhumb lines between the following points;

— N7200	E04500
— N4000	E04500
— N3500	E03700
— N3000	E03700
— N3000	W00600
— N2700	W00900
— N2700	W03000
— N6700	W03000
— N7200	W01000
— N7200	E04500

as depicted in Figure 1 below:

Figure 1

European region

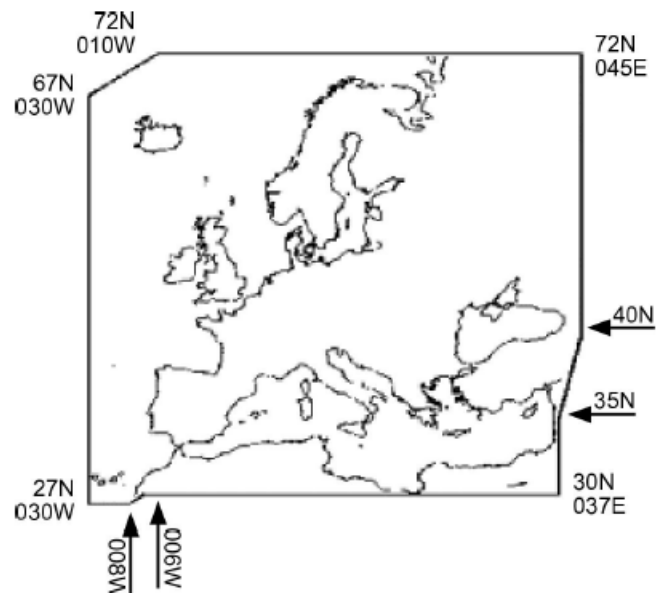

**Appendix 1 to OPS 1.620(g)****Procedure for Establishing Revised Standard Mass Values for Passengers and Baggage**

(See AMC to Appendix 1 to OPS 1.620 (g))

(a) *Passengers*

- (1) *Weight sampling method.* The average mass of passengers and their hand baggage must be determined by weighing, taking random samples. The selection of random samples must by nature and extent be representative of the passenger volume, considering the type of operation, the frequency of flights on various routes, in/outbound flights, applicable season and seat capacity of the aeroplane.
- (2) *Sample size.* The survey plan must cover the weighing of at least the greatest of:
 - (i) A number of passengers calculated from a pilot sample, using normal statistical procedures and based on a relative confidence range (accuracy) of 1% for all adult and 2% for separate male and female average masses; and
 - (ii) For aeroplanes:
 - (A) With a passenger seating capacity of 40 or more, a total of 2000 passengers; or
 - (B) With a passenger seating capacity of less than 40, a total number of 50 x (the passenger seating capacity).
- (3) *Passenger masses.* Passenger masses must include the mass of the passengers' belongings which are carried when entering the aeroplane. When taking random samples of passenger masses, infants shall be weighed together with the accompanying adult. (See also OPS 1.620(c)(d) and (e).)
- (4) *Weighing location.* The location for the weighing of passengers shall be selected as close as possible to the aeroplane, at a point where a change in the passenger mass by disposing of or by acquiring more personal belongings is unlikely to occur before the passengers board the aeroplane.
- (5) *Weighing machine.* The weighing machine to be used for passenger weighing shall have a capacity of at least 150 kg. The mass shall be displayed at minimum graduations of 500 g. The weighing machine must be accurate to within 0.5% or 200 g whichever is the greater.
- (6) *Recording of mass values.* For each flight included in the survey, the mass of the passengers, the corresponding passenger category (i.e. male/female/children) and the flight number must be recorded.

(b) *Checked baggage.* The statistical procedure for determining revised standard baggage mass values based on average baggage masses of the minimum required sample size is basically the same as for passengers and as specified in sub-paragraph (a)(1) (See also AMC OPS 1.620(g)). For baggage, the relative confidence range (accuracy) amounts to 1%. A minimum of 2000 pieces of checked baggage must be weighed.

(c) *Determination of revised standard mass values for passengers and checked baggage*



- (1) To ensure that, in preference to the use of actual masses determined by weighing, the use of revised standard mass values for passengers and checked baggage does not adversely affect operational safety, a statistical analysis must be carried out. Such an analysis will generate average mass values for passengers and baggage as well as other data. (See AMC OPS 1.620(g))
- (2) On aeroplanes with 20 or more passenger seats, these averages apply as revised standard male and female mass values.
- (3) On smaller aeroplanes, the following increments must be added to the average passenger mass to obtain the revised standard mass values:

Number of passenger seats	Required mass increment
1 – 5 incl.	16 kg
6 – 9 incl.	8 kg
10 – 19 incl.	4 kg

Alternatively, all adult revised standard (average) mass values may be applied on aeroplanes with 30 or more passenger seats. Revised standard (average) checked baggage mass values are applicable to aeroplanes with 20 or more passenger seats.

- (4) Operators have the option to submit a detailed survey plan to the Authority for approval and subsequently a deviation from the revised standard mass value provided this deviating value is determined by use of the procedure explained in this Appendix. Such deviations must be reviewed at intervals not exceeding 5 years. (See AMC to Appendix 1 to OPS 1.620(g), sub-paragraph (c)(4).)
- (5) All adult revised standard mass values must be based on a male/female ratio of 80/20 in respect of all flights except holiday charters which are 50/50. If the operator wishes to obtain approval for use of a different ratio on specific routes or flights then data must be submitted to the Authority showing that the alternative male/female ratio is conservative and covers at least 84% of the actual male/female ratios on a sample of at least 100 representative flights.
- (6) The average mass values found are rounded to the nearest whole number in kg. Checked baggage mass values are rounded to the nearest 0.5 kg figure, as appropriate.



Appendix 1 to OPS 1.625 Mass and Balance Documentation

(See AMC to Appendix 1 to OPS 1.625)

(a) *Mass and balance documentation*

(1) *Contents*

(i) The mass and balance documentation must contain the following information:

- (A) The aeroplane registration and type;
- (B) The flight identification number and date;
- (C) The identity of the commander;
- (D) The identity of the person who prepared the document;
- (E) The dry operating mass and the corresponding CG of the aeroplane;
- (F) The mass of the fuel at take-off and the mass of trip fuel;
- (G) The mass of consumables other than fuel;
- (H) The components of the load including passengers, baggage, freight and ballast;
- (I) The Take-off Mass, Landing Mass and Zero Fuel Mass;
- (J) The load distribution;
- (K) The applicable aeroplane CG positions; and
- (L) The limiting mass and CG values.

(ii) Subject to the approval of the Authority, the operator may omit some of this Data from the mass and balance documentation.

(2) *Last Minute Change.* If any last minute change occurs after the completion of the mass and balance documentation, this must be brought to the attention of the commander and the last minute change must be entered on the mass and balance documentation. The maximum allowed change in the number of passengers or hold load acceptable as a last minute change must be specified in the Operations Manual. If this number is exceeded, new mass and balance documentation must be prepared.

(b) *Computerised systems.* Where mass and balance documentation is generated by a computerised mass and balance system, the operator must verify the integrity of the output data. He must establish a system to check that amendments of his input data are incorporated properly in the system and that the system is operating correctly on a continuous basis by verifying the output data at intervals not exceeding 6 months.

(c) *Onboard mass and balance systems.* the operator must obtain the approval of the Authority if he wishes to use an onboard mass and balance computer system as a primary source for dispatch.



- (d) *Datalink.* When mass and balance documentation is sent to aeroplanes via datalink, a copy of the final mass and balance documentation as accepted by the commander must be available on the ground.



This Page Intentionally Left Blank

**SUBPART K****INSTRUMENTS AND EQUIPMENT****OPS 1.630 General Introduction**

(See AMC OPS 1.630)

- (a) The operator shall ensure that a flight does not commence unless the instruments and equipment required under this Subpart are:
- (1) approved, except as specified in sub-paragraph (c), and installed in accordance with the requirements applicable to them, including the minimum performance standard and the operational and airworthiness requirements; and
 - (2) in operable condition for the kind of operation being conducted except as provided in the MEL (OPS 1.030 refers).
- (b) Instruments and equipment minimum performance standards are those prescribed in the applicable Technical Standard Orders (TSO) unless different performance standards are prescribed in the operational or airworthiness codes. Instruments and equipment complying with design and performance specifications other than TSO may remain in service, or be installed, unless additional requirements are prescribed in this Subpart. Instruments and equipment that have already been approved do not need to comply with a revised TSO or a revised specification, other than TSO, unless a retroactive requirement is prescribed.
- (c) The following items shall not be required to have an equipment approval:
- (1) Fuses referred to in OPS 1.635;
 - (2) Electric torches referred to in OPS 1.640(a)(4);
 - (3) An accurate time piece referred to in OPS 1.650(b) & OPS 1.652(b);
 - (4) Chart holder referred to in OPS 1.652(n).
 - (5) First-aid kits referred to in OPS 1.745;
 - (6) Emergency medical kit referred to in OPS 1.755;
 - (7) Megaphones referred to in OPS 1.810;
 - (8) Survival and pyrotechnic signalling equipment referred to in OPS 1.835(a) and (c);
 - (9) Sea anchors and equipment for mooring, anchoring or manoeuvring seaplanes and amphibians on water referred to in OPS 1.840; and
 - (10) Child restraint devices referred to in OPS 1.730(a)(3).
- (d) If equipment is to be used by one flight crew member at his/her station during flight, it must be readily operable from his/her station. When a single item of equipment is required to be operated by more than one flight crew member it must be installed so that the equipment is readily operable from any station at which the equipment is required to be operated.



- (e) Those instruments that are used by any one flight crew member shall be so arranged as to permit the flight crew member to see the indications readily from his/her station, with the minimum practicable deviation from the position and line of vision which he/her normally assumes when looking forward along the flight path. Whenever a single instrument is required in an aeroplane operated by more than one flight crew member it must be installed so that the instrument is visible from each applicable flight crew station.
- (f) An aeroplane shall be equipped with instruments which will enable the flight crew to control the flight path of the aeroplane, carry out any required procedural manoeuvres and observe the operating limitations of the aeroplane in the expected operating conditions.

OPS 1.635 Circuit Protection Devices

The operator shall not operate an aeroplane in which fuses are used unless there are spare fuses available for use in flight equal to at least 10% of the number of fuses of each rating or three of each rating whichever is the greater.

OPS 1.640 Aeroplane Operating Lights

The operator shall not operate an aeroplane unless it is equipped with:

- (a) For flight by day:
 - (1) Anti-collision light system;
 - (2) Lighting supplied from the aeroplane's electrical system to provide adequate illumination for all instruments and equipment essential to the safe operation of the aeroplane;
 - (3) Lighting supplied from the aeroplane's electrical system to provide illumination in all passenger compartments; and
 - (4) An independent portable light for each required crew member readily accessible to crew members when seated at their designated station.
- (b) For flight by night, in addition to equipment specified in paragraph (a) above:
 - (1) Navigation/position lights; and
 - (2) Two landing lights or a single light having two separately energised filaments; and
 - (3) Lights to conform with the international regulations for preventing collisions at sea if the aeroplane is a Seaplane or an Amphibian.

OPS 1.645 Windshield Wipers

The operator shall not operate an aeroplane with a maximum certificated take-off mass of more than 5700 kg unless it is equipped at each pilot station with a windshield wiper or equivalent means to maintain a clear portion of the windshield during precipitation.



OPS 1.650 Day VFR Operations – Flight and Navigational Instruments and Associated Equipment

(See AMC OPS 1.650/1.652 & AMC OPS 1.650/1.652)

The operator shall not operate an aeroplane by day in accordance with Visual Flight Rules (VFR) unless it is equipped with the flight and navigational instruments and associated equipment and, where applicable, under the conditions stated in the following sub-paragraphs:

- (a) A magnetic compass;
- (b) An accurate timepiece showing the time in hours, minutes, and seconds;
- (c) A sensitive pressure altimeter calibrated in feet with a sub-scale setting, calibrated in hectopascals/millibars, adjustable for any barometric pressure likely to be set during flight;
- (d) An airspeed indicator calibrated in knots;
- (e) A vertical speed indicator;
- (f) A turn and slip indicator, or a turn co-ordinator incorporating a slip indicator;
- (g) An attitude indicator;
- (h) A stabilised direction indicator; and
- (i) A means of indicating in the flight crew compartment the outside air temperature calibrated in degrees Celsius (See AMC OPS 1.650(i) & 1.652(i)).
- (j) For flights which do not exceed 60 minutes duration, which take-off and land at the same aerodrome, and which remain within 50 NM of that aerodrome, the instruments prescribed in sub-paragraphs (f), (g) and (h) above, and sub-paragraphs (k)(4), (k)(5) and (k)(6) below, may all be replaced by either a turn and slip indicator, or a turn co-ordinator incorporating a slip indicator, or both an attitude indicator and a slip indicator.
- (k) Whenever two pilots are required the second pilot's station shall have separate instruments as follows:
 - (1) A sensitive pressure altimeter calibrated in feet with a sub-scale setting calibrated in hectopascals/millibars, adjustable for any barometric pressure likely to be set during flight;
 - (2) An airspeed indicator calibrated in knots;
 - (3) A vertical speed indicator;
 - (4) A turn and slip indicator, or a turn co-ordinator incorporating a slip indicator;
 - (5) An attitude indicator; and
 - (6) A stabilised direction indicator.
- (l) Each airspeed indicating system must be equipped with a heated pitot tube or equivalent means for preventing malfunction due to either condensation or icing for:



- (1) Aeroplanes with a maximum certificated take-off mass in excess of 5700 kg or having a maximum approved passenger seating configuration of more than 9;
 - (2) Aeroplanes first issued with an individual certificate of airworthiness on or after 1 April 1999.
- (m) Whenever duplicate instruments are required, the requirement embraces separate displays for each pilot and separate selectors or other associated equipment where appropriate.
 - (n) All aeroplanes must be equipped with means for indicating when power is not adequately supplied to the required flight instruments; and
 - (o) All aeroplanes with compressibility limitations not otherwise indicated by the required airspeed indicators shall be equipped with a Mach number indicator at each pilot's station.
 - (p) The operator shall not conduct day VFR operations unless the aeroplane is equipped with a headset with boom microphone or equivalent for each flight crew member on flight deck duty (See AMC OPS 1.650(p)/1.652(s)).
 - (q) VFR flights which are operated as controlled flights shall be equipped in accordance with OPS 1.652.

OPS 1.652 IFR or Night Operations – Flight and Navigational Instruments and Associated Equipment

(See AMC OPS 1.650/1.652 & AMC OPS 1.650/1.652)

The operator shall not operate an aeroplane in accordance with Instrument Flight Rules (IFR) or by night in accordance with Visual Flight Rules (VFR) unless it is equipped with the flight and navigational instruments and associated equipment and, where applicable, under the conditions stated in the following sub-paragraphs:

- (a) A magnetic compass;
- (b) An accurate time-piece showing the time in hours, minutes and seconds;
- (c) Two sensitive pressure altimeters calibrated in feet with sub-scale settings, calibrated in hectopascals/millibars, adjustable for any barometric pressure likely to be set during flight. These altimeters must have counter drum-pointer or equivalent presentation.
- (d) An airspeed indicating system with heated pitot tube or equivalent means for preventing malfunctioning due to either condensation or icing including a warning indication of pitot heater failure. The pitot heater failure warning indication requirement does not apply to those aeroplanes with a maximum approved passenger seating configuration of 9 or less or a maximum certificated take-off mass of 5700 kg or less and issued with an individual Certificate of Airworthiness prior to 01 April 1998 (See AMC OPS 1.652(d) & (k)(2));
- (e) A vertical speed indicator;
- (f) A turn and slip indicator;
- (g) An attitude indicator;
- (h) A stabilised direction indicator;



- (i) A means of indicating in the flight crew compartment the outside air temperature calibrated in degrees Celsius (See AMC OPS 1.650 (i) & 1.652(i)); and
- (j) Two independent static pressure systems, except that for propeller driven aeroplanes with maximum certificated take-off mass of 5700 kg or less, one static pressure system and one alternate source of static pressure is allowed.
- (k) Whenever two pilots are required the second pilot's station shall have separate instruments as follows:
 - (1) A sensitive pressure altimeter calibrated in feet with a sub-scale setting, calibrated in hectopascals/millibars, adjustable for any barometric pressure likely to be set during flight and which may be one of the 2 altimeters required by sub-paragraph (c) above. These altimeters must have counter drum-pointer or equivalent presentation.
 - (2) An airspeed indicating system with heated pitot tube or equivalent means for preventing malfunctioning due to either condensation or icing including a warning indication of pitot heater failure. The pitot heater failure warning indication requirement does not apply to those aeroplanes with a maximum approved passenger seating configuration of 9 or less or a maximum certificated take-off mass of 5700 kg or less and issued with an individual Certificate of Airworthiness prior to 1 April 1998 (See AMC OPS 1.652(d) & (k)(2));
 - (3) A vertical speed indicator;
 - (4) A turn and slip indicator;
 - (5) An attitude indicator; and
 - (6) A stabilised direction indicator.
- (l) Those aeroplanes with a maximum certificated take-off mass in excess of 5700 kg or having a maximum approved passenger seating configuration of more than 9 seats must be equipped with an additional, standby, attitude indicator (artificial horizon), capable of being used from either pilot's station, that:
 - (1) Is powered continuously during normal operation and, after a total failure of the normal electrical generating system is powered from a source independent of the normal electrical generating system;
 - (2) Provides reliable operation for a minimum of 30 minutes after total failure of the normal electrical generating system, taking into account other loads on the emergency power supply and operational procedures;
 - (3) Operates independently of any other attitude indicating system;
 - (4) Is operative automatically after total failure of the normal electrical generating system; and
 - (5) Is appropriately illuminated during all phases of operation, except for aeroplanes with a maximum certificated take-off mass of 5700 kg or less, equipped with a standby attitude indicator in the left-hand instrument panel.



- (m) In complying with sub-paragraph (l) above, it must be clearly evident to the flight crew when the standby attitude indicator, required by that sub-paragraph, is being operated by emergency power. Where the standby attitude indicator has its own dedicated power supply there shall be an associated indication, either on the instrument or on the instrument panel, when this supply is in use.
- (n) A chart holder in an easily readable position which can be illuminated for night operations.
- (o) If the standby attitude instrument system is certificated according to EASA CS 25 or equivalent, the turn and slip indicators may be replaced by slip indicators.
- (p) Whenever duplicate instruments are required, the requirement embraces separate displays for each pilot and separate selectors or other associated equipment where appropriate.
- (q) All aeroplanes must be equipped with means for indicating when power is not adequately supplied to the required flight instruments.
- (r) All aeroplanes with compressibility limitations not otherwise indicated by the required airspeed indicators shall be equipped with a Mach number indicator at each pilot's station.
- (s) The operator shall not conduct IFR or night operations unless the aeroplane is equipped with a headset with boom microphone or equivalent for each flight crew member on flight deck duty and a transmit button on the control wheel for each required pilot. (See AMC OPS 1.650(p)/1.652(s).)
- (t) Notwithstanding OPS 1.430(a)(2), (3) and (4), where aeroplanes are equipped with automatic landing systems, HUD or equivalent displays, EVS, SVS or CVS, or any combination of those systems into a hybrid system, criteria for the use of such systems for the safe operation of an aeroplane shall be established by the Authority.

OPS 1.655 Additional Equipment for Single-pilot Operation under IFR or at night

(See CAR OPS 1.940(b))

- (a) An aeroplane shall not be operated under the IFR or at night by a single pilot unless approved by the Authority.
- (b) An aeroplane shall not be operated under the IFR or at night by a single pilot unless:
 - (1) the flight manual does not require a flight crew of more than one;
 - (2) the aeroplane is propeller-driven;
 - (3) the maximum approved passenger seating configuration is not more than nine;
 - (4) the maximum certificated take-off mass does not exceed 5700 kg;
 - (5) the aeroplane is equipped as described in OPS 1.652; and
 - (6) the pilot-in-command has satisfied requirements of experience, training, checking and recency described in Appendix 2 to CAR OPS 1.940.
- (c) The operator shall not conduct single-pilot IFR operations unless the aeroplane is equipped with an autopilot with at least altitude hold and heading mode.

**OPS 1.660 Altitude Alerting System**

- (a) The operator shall not operate a turbine propeller powered aeroplane with a maximum certificated take-off mass in excess of 5700 kg or having a maximum approved passenger seating configuration of more than 9 seats or a turbojet powered aeroplane unless it is equipped with an altitude alerting system capable of:
- (1) alerting the flight crew upon approaching a preselected altitude; and
 - (2) alerting the flight crew by at least an aural signal, when deviating from a preselected altitude,
- except for aeroplanes with a maximum certificated take-off mass of 5700 kg or less having a maximum approved passenger seating configuration of more than 9 and first issued with an individual certificate of airworthiness before 01 April 1972.

OPS 1.665 Ground Proximity Warning System and Terrain Awareness Warning System

- (a) The operator shall not operate a turbine-engined aeroplane having a maximum certificated take-off mass in excess of 5700 kg or a maximum approved passenger seating configuration of more than 9 unless it is equipped with a ground proximity warning system that includes a forward-looking terrain hazard avoidance function (Terrain Awareness and Warning System – TAWS).
- (b) The operator shall implement database management procedures that ensure the timely distribution and update of current terrain and obstacle data to the ground proximity warning system.
- (c) The operator shall not operate a piston-engined aeroplane of a maximum certificated take-off mass in excess of 5700 kg or authorised to carry more than nine passengers shall be equipped with a ground proximity warning system which provides the warnings in sub-paragraph (e)(1) and (3) below, warning of unsafe terrain clearance and a forward looking terrain avoidance function.
- (d) A ground proximity warning system shall provide automatically a timely and distinctive warning to the flight when the aeroplane is in a potentially hazardous proximity to the earth's surface.
- (e) A ground proximity warning system shall provide, unless otherwise specified herein, warnings of the following circumstances:
- (1) excessive descent rate;
 - (2) excessive terrain closure rate;
 - (3) excessive altitude loss after take-off or go-around;
 - (4) unsafe terrain clearance while not in landing configuration:
 - (i) gear not locked down;
 - (ii) flaps not in a landing position; and
 - (5) excessive descent below the instrument glide path.
- (f) All turbine-engined aeroplanes of a maximum certificated take-off mass of 5 700 kg or less and authorized to carry more than five but not more than nine passengers for which the individual certificate of airworthiness is first issued on or after 01 January 2026, shall be equipped with a



ground proximity warning system which provides the warnings of paragraph (e)(1) and (3) above, warning of unsafe terrain clearance and a forward looking terrain avoidance function.

OPS 1.668 Airborne Collision Avoidance System

(See AMC OPS 1.668)

- (a) All turbine-engine aeroplanes of a maximum certificated take-off mass in excess of 5700 kg or authorised to carry more than 19 passengers shall be equipped with an airborne collision avoidance system with a minimum performance level of at least ACAS II, that meets traffic alert and collision avoidance system (TCAS) Version 7.1 as specified in RTCA/DO-185B or EUROCAE/ED-143.
- (b) An airborne collision avoidance system shall operate in accordance with the relevant provisions of Annex 10, Volume IV.

OPS 1.670 Airborne Weather Radar Equipment

- (a) The operator shall not operate:
 - (1) A pressurised aeroplane; or
 - (2) An unpressurised aeroplane which has a maximum certificated take-off mass of more than 5700 kg; or
 - (3) An unpressurised aeroplane having a maximum approved passenger seating configuration of more than 9 seats;

unless it is equipped with airborne weather radar equipment whenever such an aeroplane is being operated at night or in instrument meteorological conditions in areas where thunderstorms or other potentially hazardous weather conditions, regarded as detectable with airborne weather radar, may be expected to exist along the route.

- (b) For propeller driven pressurised aeroplanes having a maximum certificated take-off mass not exceeding 5700 kg with a maximum approved passenger seating configuration not exceeding 9 seats the airborne weather radar equipment may be replaced by other equipment capable of detecting thunderstorms and other potentially hazardous weather conditions, regarded as detectable with airborne weather radar equipment, subject to approval by the Authority.

OPS 1.672 Runway Overrun Awareness and Alerting System (ROAAS)

All turbine-engined aeroplanes of a maximum certificated take-off mass in excess of 5 700 kg, for which the individual certificate of airworthiness is first issued on or after 01 January 2026, shall be equipped with a runway overrun awareness and alerting system (ROAAS).

Note: Guidance material for ROAAS design is contained in EUROCAE ED-250, Minimum Operation Performance Specification (MOPS) for Runway Overrun Awareness and Alerting System (ROAAS), or equivalent documents.

OPS 1.675 Equipment for Operations in Icing Conditions

- (a) The operator shall not operate an aeroplane in expected or actual icing conditions unless it is certificated and equipped to operate in icing conditions.



- (b) The operator shall not operate an aeroplane in expected or actual icing conditions at night unless it is equipped with a means to illuminate or detect the formation of ice. Any illumination that is used must be of a type that will not cause glare or reflection that would handicap crew members in the performance of their duties.

OPS 1.680 Cosmic Radiation Detection Equipment

- (a) The operator shall not operate an aeroplane above 15000 m (49000 ft) unless:
- (1) it is equipped with an instrument to measure and indicate continuously the dose rate of total cosmic radiation being received (i.e. the total of ionizing and neutron radiation of galactic and solar origin) and the cumulative dose on each flight, or
 - (2) a system of on-board quarterly radiation sampling acceptable to the Authority is established (See AC OPS 1.680(a)(2)).

OPS 1.685 Flight Crew Interphone System

The operator shall not operate an aeroplane on which a flight crew of more than one is required unless it is equipped with a flight crew interphone system, including headsets and microphones, not of a handheld type, for use by all members of the flight crew.

OPS 1.690 Crew Member Interphone System

- (a) The operator shall not operate an aeroplane having a maximum approved passenger seating configuration of more than 19 unless it is equipped with a crew member interphone system.
- (b) The crew member interphone system required by this paragraph must:
- (1) operate independently of the public address system except for handsets, headsets, microphones, selector switches and signalling devices;
 - (2) provide a means of two-way communication between the flight crew compartment and:
 - (i) each passenger compartment;
 - (ii) each galley located other than on a passenger deck level; and
 - (iii) each remote crew compartment that is not on the passenger deck and is not easily accessible from a passenger compartment;
 - (3) be readily accessible for use from each of the required flight crew stations in the flight crew compartment;
 - (4) be readily accessible for use at required cabin crew member stations close to each separate or pair of floor level emergency exits;
 - (5) have an alerting system incorporating aural or visual signals for use by flight crew members to alert the cabin crew and for use by cabin crew members to alert the flight crew;
 - (6) have a means for the recipient of a call to determine whether it is a normal call or an emergency call (See AMC OPS 1.690(b)(6)); and



- (7) provide on the ground a means of two-way communication between ground personnel and at least two flight crew members. (See AMC OPS 1.690(b)(7)).

OPS 1.695 Public Address System

- (a) The operator shall not operate an aeroplane with a maximum approved passenger seating configuration of more than 19 unless a public address system is installed.
- (b) The public address system required by this paragraph must:
 - (1) operate independently of the interphone systems except for handsets, headsets, microphones, selector switches and signalling devices;
 - (2) be readily accessible for immediate use from each required flight crew member station;
 - (3) for each required floor level passenger emergency exit which has an adjacent cabin crew seat, have a microphone which is readily accessible to the seated cabin crew member, except that one microphone may serve more than one exit, provided the proximity of the exits allows unassisted verbal communication between seated cabin crew members;
 - (4) be capable of operation within 10 seconds by a cabin crew member at each of those stations in the compartment from which its use is accessible; and
 - (5) be audible and intelligible at all passenger seats, toilets and cabin crew seats and work stations.

OPS 1.700 Cockpit Voice Recorders

(See Appendix 1 to OPS 1.700)

(See Appendix 1 to OPS 1.700/OPS 1.710/OPS 1.715)

(See Appendix 2 to OPS 1.700/OPS 1.710/OPS 1.715)

(See AC OPS 1.700)

- (a) All turbine-engined aeroplanes of a maximum certificated take-off mass of over 2 250 kg, up to and including 5700 kg, for which the application for type certification is submitted to a Contracting State on or after 01 January 2016 and required to be operated by more than one pilot shall be equipped with either a CVR or a CARS.
- (b) All aeroplanes of a maximum certificated take-off mass of over 5700 kg for which the individual certificate of airworthiness is first issued on or after 01 January 1987 shall be equipped with a CVR.
- (c) All turbine-engined aeroplanes, for which the individual certificate of airworthiness was first issued before 01 January 1987, with a maximum certificated take-off mass of over 27000 kg that are of types of which the prototype was certificated by the appropriate national authority after 30 September 1969 shall be equipped with a CVR.
- (d) CVRs and CARS shall not use magnetic tape or wire.
- (e) All CVRs shall retain the information recorded during at least the last 2 hours of their operation.
- (f) All aeroplanes of a maximum certificated take-off mass of over 27000 kg for which the individual certificate of airworthiness is first issued on or after 01 January 2022 shall be equipped with a CVR which shall retain the information recorded during at least the last 25 hours of its operation.



- (g) All aeroplanes that are required to be equipped with CARS, and for which the individual certificate of airworthiness is first issued on or after 01 January 2025, shall be equipped with a CARS which shall retain the information recorded during at least the last two hours of their operation.
- [(h)(1) All aeroplanes of a maximum certificated take-off mass of over 27000 kg for which the application for type certification is submitted to a Contracting State on or after 01 January 2018, shall be provided with an alternate power source as defined in (h)(2), that powers the forward CVR in the case of combination recorders.
- (h)(2) An alternate power source shall automatically engage and provide 10 minutes, plus or minus one minute, of operation whenever aeroplane power to the recorder ceases, either by normal shutdown or by any other loss of power. The alternate power source shall power the CVR and its associated cockpit area microphone components. The CVR shall be located as close as practicable to the alternate power source.

Note 1: "Alternate" means separate from the power source that normally provides power to the CVR. The use of aeroplane batteries or other power sources is acceptable provided that the requirements above are met and electrical power to essential and critical loads is not compromised.

Note 2: When the CVR function is combined with other recording functions within the same unit, powering the other functions is allowed.]

OPS 1.710 Flight Data Recorders – Aeroplanes of 5700 kg or Less

(See Appendix 1 to OPS 1.700/OPS 1.710/OPS 1.715)

(See Appendix 2 to OPS 1.700/OPS 1.710/OPS 1.715)

(See Appendix 1 to OPS 1.710/OPS 1.715)

(See Appendix 2 to OPS 1.710/OPS 1.715)

(See Appendix 3 to OPS 1.710/OPS 1.715)

(See Appendix 1 to OPS 1.710)

(See Appendix 2 to OPS 1.710)

(See AC OPS 1.710/OPS 1.715)

- (a) All turbine-engined aeroplanes of a maximum certificated take-off mass of 5700 kg or less for which the application for type certification is submitted to a Contracting State on or after 01 January 2016 shall be equipped with:
- (1) an FDR which shall record at least parameters 1-16 listed in Appendix 3 to OPS 1.710/OPS 1.715; or
 - (2) a Class C AIR or AIRS which shall record at least flight path and speed parameters displayed to the pilot(s), as defined in Appendix 2 to OPS 1.710/OPS 1.715), paragraph (b)(3); or
 - (3) an ADRS which shall record at least parameters 1-7 listed in Appendix 2 to OPS 1.710.
- (b) FDRs or ADRS shall not use engraving metal foil, frequency modulation (FM), photographic film or magnetic tape.

Note: "The application for type certification is submitted to a Contracting State" refers to the date of application of the original "Type Certificate" for the aeroplane type, not the date of certification of particular aeroplane variants or derivative models.

**OPS 1.715 Flight Data Recorders – Aeroplanes Greater than 5700 kg**

(See Appendix 1 to OPS 1.700/OPS 1.710/OPS 1.715)

(See Appendix 2 to OPS 1.700/OPS 1.710/OPS 1.715)

(See Appendix 1 to OPS 1.710/OPS 1.715)

(See Appendix 2 to OPS 1.710/OPS 1.715)

(See Appendix 3 to OPS 1.710/OPS 1.715)

(See Appendix 1 to OPS 1.710)

- (a) All turbine-engined aeroplanes, for which the individual certificate of airworthiness was first issued before 01 January 1989, with a maximum certificated take-off mass of over 5700 kg, except those in sub-paragraph (e) shall be equipped with an FDR which shall record at least parameters 1-5 listed in Appendix 3 to OPS 1.710/OPS 1.715.
- (b) All aeroplanes of a maximum certificated take-off mass of over 5700 kg, up to and including 27000 kg, for which the individual certificate of airworthiness is first issued on or after 01 January 1989, shall be equipped with a FDR which shall record at least parameters 1-16 listed in Appendix 3 to OPS 1.710/1.715.
- (c) All aeroplanes of a maximum certificated take-off mass of over 5700 kg for which the individual certificate of airworthiness is first issued after 01 January 2005 shall be equipped with a FDR which shall record at least parameters 1-78 listed in Appendix 3 to OPS 1.710/OPS 1.715.
- (d) All aeroplanes of a maximum certificated take-off mass of over 5700 kg for which the application for type certification is submitted to a Contracting State on or after 01 January 2023 shall be equipped with an FDR capable of recording at least the 82 parameters listed in Appendix 3 to OPS 1.710/OPS 1.715.
- (e) All turbine-engined aeroplanes, for which the individual certificate of airworthiness was first issued on or after 01 January 1987, but before 01 January 1989, with a maximum certificated take-off mass of over 27000 kg that are of types of which the prototype was certificated by the appropriate national authority after 30 September 1969 shall be equipped with a FDR which shall record at least parameters 1-16 listed in Appendix 3 to OPS 1.710/OPS 1.715.
- (f) All aeroplanes of a maximum certificated take-off mass of over 27000 kg for which the individual certificate of airworthiness is first issued on or after 01 January 1989 shall be equipped with a FDR which shall record at least parameters 1-32 listed in Appendix 3 to OPS 1.710/OPS 1.715.
- (g) All aeroplanes of a maximum take-off mass of over 27000 kg for which the application for type certification is submitted to a Contracting State on or after 01 January 2023 shall be equipped with a crash-protected flight recorder which shall record the information displayed to the flight crew from electronic displays, as well as the operation of switches and selectors by the flight crew as defined in these regulations. (See Appendix 1 to OPS 1.710)
- (h) FDRs shall not use engraving metal foil, frequency modulation (FM), photographic film or magnetic tape.
- (i) All FDRs shall retain the information recorded during at least the last 25 hours of their operation, and in addition sufficient information from the preceding take-off for calibration purposes.
- (j) FDRs that meet the current parameter certification requirements of the FAA, Transport Canada or EASA in respect to commercial air transport operations shall be exempt from meeting the parameter requirements of CAR OPS 1.715.



Note: “The application for type certification is submitted to a Contracting State” refers to the date of application of the original “Type Certificate” for the aeroplane type, not the date of certification of particular aeroplane variants or derivative models.

OPS 1.720 Flight Data Recorders – Data Link

(See Appendix 2 to OPS 1.710/OPS 1.715)

- (a) All aeroplanes for which the individual certificate of airworthiness is first issued after 01 January 2016, which use any of the data link communications applications referred to in Appendix 2 to OPS 1.710/OPS 1.715 and are required to carry a CVR, shall record the data link communication messages on a crash protected flight recorder.
- (b) All aeroplanes for which the individual certificate of airworthiness was first issued before 01 January 2016, that are required to carry a CVR and are modified on or after 01 January 2016 to use any of the data link communications applications referred to in Appendix 2 to OPS 1.710/OPS 1.715 shall record the data link communication messages on a crash protected flight recorder unless the installed data link communications equipment is compliant with a type certificate issued or aircraft modification first approved prior to 01 January 2016.

Note: The “aircraft modifications” refer to modifications to install the data link communications equipment on the aircraft (e.g. structural, wiring).

- (c) The minimum recording duration shall be equal to the duration of the CVR.
- (d) Data link recording shall be able to be correlated to the recorded cockpit audio.

OPS 1.725 Combination Recorders

All aeroplanes of a maximum certificated take-off mass of over 15000 kg for which the application for certification is submitted to a Contracting State on or after 01 January 2016 and which are required to be equipped with both a CVR and an FDR, shall be equipped with two combination recorders (FDR/CVR). One recorder shall be located as close to the cockpit as practicable and the other recorder located as far aft as practicable.

OPS 1.730 Seats, Seat Safety Belts, Harnesses and Child Restraint Devices

- (a) The operator shall not operate an aeroplane unless it is equipped with:
 - (1) a seat or berth for each person who is aged two years or more;
 - (2) a safety belt, with or without a diagonal shoulder strap, or a safety harness for use in each passenger seat for each passenger aged two years or more;
 - (3) a child restraint device, acceptable to the Authority, for each infant (See AC OPS 1.730(a)(3));
 - (4) except as provided in sub-paragraph (c) below, a safety belt with shoulder harness for each flight crew seat and for any seat alongside a pilot’s seat incorporating a device which will automatically restrain the occupant’s torso in the event of rapid deceleration;

Note 1: The safety harness for each pilot seat should incorporate a device to prevent a suddenly incapacitated pilot from interfering with the flight controls.



Note 2: Safety harness includes shoulder straps and a seat belt which may be used independently.

- (5) except as provided in sub-paragraph (c) below, a safety belt with shoulder harness for each cabin crew seat and observer's seats. However, this requirement does not preclude use of passenger seats by cabin crew members carried in excess of the required cabin crew complement; and
 - (6) seats for cabin crew members located near required floor level emergency exits except that, if the emergency evacuation of passengers would be enhanced by seating cabin crew members elsewhere, other locations are acceptable. The seats shall be forward or rearward facing within 15° of the longitudinal axis of the aeroplane.
- (b) All safety belts with shoulder harness must have a single point release.
- (c) A safety belt with a diagonal shoulder strap for aeroplanes with a maximum certificated take-off mass not exceeding 5700 kg or a safety belt for aeroplanes with a maximum certificated take-off mass not exceeding 2 730 kg may be permitted in place of a safety belt with shoulder harness if it is not reasonably practicable to fit the latter.

OPS 1.731 Fasten Seat belt and No Smoking Signs

The operator shall not operate an aeroplane in which all passenger seats are not visible from the flight deck, unless it is equipped with a means of indicating to all passengers and cabin crew when seat belts shall be fastened and when smoking is not allowed.

OPS 1.735 Internal Doors and Curtains

The operator shall not operate an aeroplane unless the following equipment is installed:

- (a) In an aeroplane with a maximum approved passenger seating configuration of more than 19 passengers, a door between the passenger compartment and the flight deck compartment with a placard 'crew only' and a locking means to prevent passengers from opening it without the permission of a member of the flight crew;
- (b) A means for opening each door that separates a passenger compartment from another compartment that has emergency exit provisions. The means for opening must be readily accessible;
- (c) If it is necessary to pass through a doorway or curtain separating the passenger cabin from other areas to reach any required emergency exit from any passenger seat, the door or curtain must have a means to secure it in the open position;
- (d) A placard on each internal door or adjacent to a curtain that is the means of access to a passenger emergency exit, to indicate that it must be secured open during take-off and landing; and
- (e) A means for any member of the crew to unlock any door that is normally accessible to passengers and that can be locked by passengers.



OPS 1.745 First-Aid Kits

(See AMC OPS 1.745)

- (a) The operator shall not operate an aeroplane unless it is equipped with first-aid kits, readily accessible for use, to the following scale:

Number of passenger seats installed	Number of First-Aid Kits required
0 to 99	1
100 to 199	2
200 to 299	3
300 and more	4

- (b) The operator shall ensure that first-aid kits are:
 - (1) Inspected periodically to confirm, to the extent possible, that contents are maintained in the condition necessary for their intended use; and
 - (2) Replenished at regular intervals, in accordance with instructions contained on their labels, or as circumstances warrant.

OPS 1.755 Emergency Medical Kit

(See AMC OPS 1.755)

- (a) The operator shall not operate an aeroplane with a maximum approved passenger seating configuration of more than 30 seats unless it is equipped with an emergency medical kit if any point on the planned route is more than 60 minutes flying time (at normal cruising speed) from an aerodrome at which qualified medical assistance could be expected to be available.
- (b) The commander shall ensure that drugs are not administered except by qualified doctors, nurses or similarly qualified personnel.
- (c) Conditions for carriage
 - (1) The emergency medical kit must be dust and moisture proof and shall be carried under security conditions, where practicable, on the flight deck; and
 - (2) The operator shall ensure that emergency medical kits are:
 - (i) inspected periodically to confirm, to the extent possible, that the contents are maintained in the condition necessary for their intended use; and
 - (ii) replenished at regular intervals, in accordance with instructions contained on their labels, or as circumstances warrant.

OPS 1.760 First-aid Oxygen

(See AMC OPS 1.760)

- (a) The operator shall not operate a pressurised aeroplane, above 25000 ft, when a cabin crew member is required to be carried, unless it is equipped with a supply of undiluted oxygen for passengers who, for physiological reasons, might require oxygen following a cabin depressurisation.



- (b) The amount of oxygen shall be calculated using an average flow rate of at least 3 litres Standard Temperature Pressure Dry (STPD)/minute/person and shall be sufficient for the remainder of the flight after cabin depressurisation when the cabin altitude exceeds 8000 ft but does not exceed 15000 ft, for at least 2% of the passengers carried, but in no case for less than one person.
- (c) There shall be a sufficient number of dispensing units, but in no case less than two, with a means for cabin crew to use the supply. The dispensing units may be of a portable type.
- (d) The amount of first-aid oxygen required for a particular operation shall be determined on the basis of cabin pressure altitudes and flight duration, consistent with the operating procedures established for each operation and route.
- (e) The oxygen equipment provided shall be capable of generating a mass flow to each user of at least 4 litres per minute, STPD. Means may be provided to decrease the flow to not less than 2 litres per minute, STPD, at any altitude.

OPS 1.770 Supplemental Oxygen – Pressurised Aeroplanes

(See Appendix 1 to OPS 1.770)

(See AMC OPS 1.770)

- (a) General
 - (1) The operator shall not operate a pressurised aeroplane at pressure altitudes above 10000 ft unless supplemental oxygen equipment, capable of storing and dispensing the oxygen supplies required by this paragraph, is provided.
 - (2) The amount of supplemental oxygen required shall be determined on the basis of cabin pressure altitude, flight duration and the assumption that a cabin pressurisation failure will occur at the pressure altitude or point of flight that is most critical from the standpoint of oxygen need, and that, after the failure, the aeroplane will descend in accordance with emergency procedures specified in the Aeroplane Flight Manual to a safe altitude for the route to be flown that will allow continued safe flight and landing.
 - (3) Following a cabin pressurisation failure, the cabin pressure altitude shall be considered the same as the aeroplane pressure altitude, unless it is demonstrated to the Authority that no probable failure of the cabin or pressurisation system will result in a cabin pressure altitude equal to the aeroplane pressure altitude. Under these circumstances, the demonstrated maximum cabin pressure altitude may be used as a basis for determination of oxygen supply.
- (b) Oxygen equipment and supply requirements
 - (1) Flight crew members
 - (i) Each member of the flight crew on flight deck duty shall be supplied with supplemental oxygen in accordance with Appendix 1. If all occupants of flight deck seats are supplied from the flight crew source of oxygen supply then they shall be considered as flight crew members on flight deck duty for the purpose of oxygen supply. Flight deck seat occupants, not supplied by the flight crew source, are to be considered as passengers for the purpose of oxygen supply.
 - (ii) Flight crew members, not covered by sub-paragraph (b)(1)(i) above, are to be considered as passengers for the purpose of oxygen supply.



- (iii) Oxygen masks shall be located so as to be within the immediate reach of flight crew members whilst at their assigned duty station.
 - (iv) Oxygen masks for use by flight crew members in pressurised aeroplanes operating at pressure altitudes above 25000 ft, shall be a quick donning type of mask.
- (2) Cabin crew members, additional crew members and passengers
- (i) Cabin crew members and passengers shall be supplied with supplemental oxygen in accordance with Appendix 1, except when sub-paragraph (v) below applies. Cabin crew members carried in addition to the minimum number of cabin crew members required, and additional crew members, shall be considered as passengers for the purpose of oxygen supply.
 - (ii) Aeroplanes intended to be operated at pressure altitudes above 25000 ft shall be provided sufficient spare outlets and masks and/or sufficient portable oxygen units with masks for use by all required cabin crew members. The spare outlets and/or portable oxygen units are to be distributed evenly throughout the cabin to ensure immediate availability of oxygen to each required cabin crew member regardless of his/her location at the time of cabin pressurisation failure.
 - (iii) Aeroplanes intended to be operated at pressure altitudes above 25000 ft shall be provided an oxygen dispensing unit connected to oxygen supply terminals immediately available to each occupant, wherever seated. The total number of dispensing units and outlets shall exceed the number of seats by at least 10%. The extra units are to be evenly distributed throughout the cabin.
 - (iv) Aeroplanes intended to be operated at pressure altitudes above 25000 ft or which, if operated at or below 25000 ft, cannot descend safely within 4 minutes to 13000 ft, shall be provided with automatically deployable oxygen equipment immediately available to each occupant, wherever seated. The total number of dispensing units and outlets shall exceed the number of seats by at least 10%. The extra units are to be evenly distributed throughout the cabin.
 - (v) The oxygen supply requirements, as specified in Appendix 1, for aeroplanes not certificated to fly above 25000 ft, may be reduced to the entire flight time between 10000 ft and 13000 ft cabin pressure altitudes for all required cabin crew members and for at least 10% of the passengers if, at all points along the route to be flown, the aeroplane is able to descend safely within 4 minutes to a cabin pressure altitude of 13000 ft. (See AC OPS 1.770(b)(v)).

OPS 1.772 Safeguarding of Cabin Crew and Passengers in Pressurised Aeroplanes in the Event of Loss of Pressurisation

- (a) Cabin crew shall be safeguarded so as to ensure reasonable probability of their retaining consciousness during any emergency descent which may be necessary in the event of loss of pressurisation and, in addition, they should have such means of protection as will enable them to administer first aid to passengers during stabilized flight following the emergency.
- (b) Passengers shall be safeguarded by such devices or operational procedures as will ensure reasonable probability of their surviving the effects of hypoxia in the event of loss of pressurisation.



Note: It is not envisaged that cabin crew will always be able to provide assistance to passengers during emergency descent procedures which may be required in the event of loss of pressurisation.

OPS 1.775 Supplemental Oxygen – Non-pressurised Aeroplanes

(See Appendix 1 to OPS 1.775)

(a) General

- (1) The operator shall not operate a non-pressurised aeroplane at altitudes above 10000 ft unless supplemental oxygen equipment, capable of storing and dispensing the oxygen supplies required, is provided.
- (2) The amount of supplemental oxygen for sustenance required for a particular operation shall be determined on the basis of flight altitudes and flight duration, consistent with the operating procedures established for each operation in the Operations Manual and with the routes to be flown, and with the emergency procedures specified in the Operations Manual.
- (3) An aeroplane intended to be operated at pressure altitudes above 10000 ft shall be provided with equipment capable of storing and dispensing the oxygen supplies required.

(b) Oxygen supply requirements

- (1) *Flight crew members.* Each member of the flight crew on flight deck duty shall be supplied with supplemental oxygen in accordance with Appendix 1. If all occupants of flight deck seats are supplied from the flight crew source of oxygen supply then they shall be considered as flight crew members on flight deck duty for the purpose of oxygen supply.
- (2) *Cabin crew members, additional crew members and passengers.* Cabin crew members and passengers shall be supplied with oxygen in accordance with Appendix 1 to OPS 1.775. Cabin crew members carried in addition to the minimum number of cabin crew members required, and additional crew members, shall be considered as passengers for the purpose of oxygen supply.

OPS 1.780 Crew Protective Breathing Equipment

- (a) The operator shall not operate a pressurised aeroplane or, after 1 April 2000, an unpressurised aeroplane with a maximum certificated take-off mass exceeding 5700 kg or having a maximum approved seating configuration of more than 19 seats unless:
 - (1) It has equipment to protect the eyes, nose and mouth of each flight crew member while on flight deck duty and to provide oxygen for a period of not less than 15 minutes. The supply for Protective Breathing Equipment (PBE) may be provided by the supplemental oxygen required by OPS 1.770(b)(1) or OPS 1.775(b)(1). In addition, when the flight crew is more than one and a cabin crew member is not carried, portable PBE must be carried to protect the eyes, nose and mouth of one member of the flight crew and to provide breathing gas for a period of not less than 15 minutes; and
 - (2) It has sufficient portable PBE to protect the eyes, nose and mouth of all required cabin crew members and to provide breathing gas for a period of not less than 15 minutes.
- (b) PBE intended for flight crew use must be conveniently located on the flight deck and be easily accessible for immediate use by each required flight crew member at their assigned duty station.



- (c) PBE intended for cabin crew use must be installed adjacent to each required cabin crew member duty station.
- (d) An additional, easily accessible portable PBE must be provided and located at or adjacent to the hand fire extinguishers required by OPS 1.790(c) and (d) except that, where the fire extinguisher is located inside a cargo compartment, the PBE must be stowed outside but adjacent to the entrance to that compartment.
- (e) PBE while in use must not prevent communication where required by OPS 1.685, OPS 1.690, OPS 1.810 and OPS 1.850.

OPS 1.790 Hand Fire Extinguishers

(See AMC OPS 1.790)

The operator shall not operate an aeroplane unless hand fire extinguishers are provided for use in crew, passenger and, as applicable, cargo compartments and galleys in accordance with the following:

- (a) The type and quantity of extinguishing agent must be suitable for the kinds of fires likely to occur in the compartment where the extinguisher is intended to be used and, for personnel compartments, must minimise the hazard of toxic gas concentration;
- (b) At least one hand fire extinguisher, containing Halon 1211 (bromochlorodifluoro-methane, CBrClF₂), or equivalent as the extinguishing agent, must be conveniently located on the flight deck for use by the flight crew;
- (c) At least one hand fire extinguisher must be located in, or readily accessible for use in, each galley not located on the main passenger deck;
- (d) At least one readily accessible hand fire extinguisher must be available for use in each Class A or Class B cargo or baggage compartment and in each Class E cargo compartment that is accessible to crew members in flight; and
- (e) At least the following number of hand fire extinguishers must be conveniently located in the passenger compartment(s):

Maximum approved passenger seating configuration	Number of Extinguishers
7 to 30	1
31 to 60	2
61 to 200	3
201 to 300	4
301 to 400	5
401 to 500	6
501 to 600	7
601 or more	8

When two or more extinguishers are required, they must be evenly distributed in the passenger compartment.

- (f) At least one of the required fire extinguishers located in the passenger compartment of an aeroplane with a maximum approved passenger seating configuration of at least 31, and not more than 60, and at least two of the fire extinguishers located in the passenger compartment of an aeroplane with a maximum approved passenger seating configuration of 61 or more must contain Halon 1211 (bromochlorodi-fluoromethane, CBrClF₂), or equivalent as the



extinguishing agent.

- (g) Any agent used in a built-in fire extinguisher for each lavatory disposal receptacle for towels, paper or waste in an aeroplane for which the individual certificate of airworthiness is first issued on or after 31 December 2011 and any extinguishing agent used in a portable fire extinguisher in an aeroplane for which the individual certificate of airworthiness is first issued on or after 31 December 2018 shall:
 - (1) meet the applicable minimum performance requirements of the State of Registry; and
 - (2) not be of a type listed in Annex A, Group II of the *Montreal Protocol on Substances That Deplete the Ozone Layer*, current edition.

OPS 1.795 Crash Axes and Crowbars

- (a) The operator shall not operate an aeroplane with a maximum certificated take-off mass exceeding 5700 kg or having a maximum approved passenger seating configuration of more than 9 seats unless it is equipped with at least one crash axe or crowbar located on the flight deck. If the maximum approved passenger seating configuration is more than 200 an additional crash axe or crowbar must be carried and located in or near the most rearward galley area.
- (b) Crash axes and crowbars located in the passenger compartment must not be visible to passengers.

OPS 1.800 Marking of Break-in Points

The operator shall ensure that, if areas of the fuselage suitable for break-in by rescue crews in emergency are marked on an aeroplane, such areas shall be marked as shown below. The colour of the markings shall be red or yellow, and if necessary they shall be outlined in white to contrast with the background. If the corner markings are more than 2 metres apart, intermediate lines 9 cm x 3 cm shall be inserted so that there is no more than 2 metres between adjacent marks.

Note: This regulation does not require any aircraft to have break-in areas.

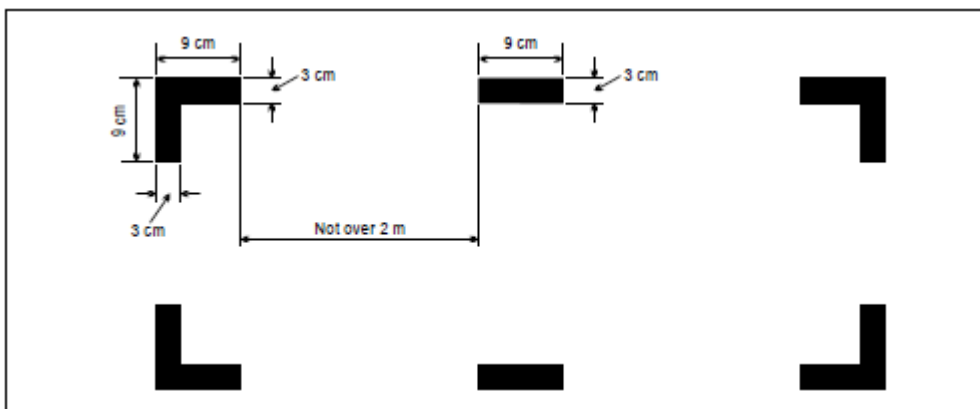

OPS 1.805 Means for Emergency Evacuation

- (a) The operator shall not operate an aeroplane with passenger emergency exit sill heights:
 - (1) Which are more than 1.83 metres (6 feet) above the ground with the aeroplane on the ground and the landing gear extended; or



- (2) Which would be more than 1.83 metres (6 feet) above the ground after the collapse of, or failure to extend of, one or more legs of the landing gear and for which a Type Certificate was first applied for on or after 1 April 2000,

unless it has equipment or devices available at each exit, where sub-paragraphs (1) or (2) apply, to enable passengers and crew to reach the ground safely in an emergency.

- (b) Such equipment or devices need not be provided at overwing exits if the designated place on the aeroplane structure at which the escape route terminates is less than 1.83 metres (6 feet) from the ground with the aeroplane on the ground, the landing gear extended, and the flaps in the take-off or landing position, whichever flap position is higher from the ground.
- (c) In aeroplanes required to have a separate emergency exit for the flight crew and:
 - (1) For which the lowest point of the emergency exit is more than 1.83 metres (6 feet) above the ground with the landing gear extended; or,
 - (2) For which a Type Certificate was first applied for on or after 1 April 2000, would be more than 1.83 metres (6 ft) above the ground after the collapse of, or failure to extend of, one or more legs of the landing gear,

there must be a device to assist all members of the flight crew in descending to reach the ground safely in an emergency.

OPS 1.810 Megaphones
(See AMC OPS 1.810)

- (a) The operator shall not operate an aeroplane with a maximum approved passenger seating configuration of more than 60 and carrying one or more passengers unless it is equipped with portable battery-powered megaphones readily accessible for use by crew members during an emergency evacuation, to the following scales:
 - (1) For each passenger deck:

Passenger seating configuration	Number of Megaphones Required
61 to 99	1
100 or more	2

- (2) For aeroplanes with more than one passenger deck, in all cases when the total passenger seating configuration is more than 60, at least 1 megaphone is required.

OPS 1.815 Emergency Lighting

- (a) The operator shall not operate a passenger carrying aeroplane which has a maximum approved passenger seating configuration of more than 9 unless it is provided with an emergency lighting system having an independent power supply to facilitate the evacuation of the aeroplane. The emergency lighting system must include:
 - (1) For aeroplanes which have a maximum approved passenger seating configuration of more than 19:
 - (i) Sources of general cabin illumination;
 - (ii) Internal lighting in floor level emergency exit areas; and



- (iii) Illuminated emergency exit marking and locating signs.
 - (iv) For aeroplanes for which the application for the type certificate or equivalent was filed before 1 May 1972, and when flying by night, exterior emergency lighting at all overwing exits, and at exits where descent assist means are required.
 - (v) For aeroplanes for which the application for the type certificate or equivalent was filed on or after 1 May 1972, and when flying by night, exterior emergency lighting at all passenger emergency exits.
 - (vi) For aeroplanes for which the type certificate was first issued on or after 01 January 1958, floor proximity emergency escape path marking system in the passenger compartment(s).
- (2) For aeroplanes which have a maximum approved passenger seating configuration of 19 or less and are certificated to EASA CS–23 or CS–25, or equivalent:
- (i) Sources of general cabin illumination;
 - (ii) Internal lighting in emergency exit areas; and
 - (iii) Illuminated emergency exit marking and locating signs.
- (3) For aeroplanes which have a maximum approved passenger seating configuration of 19 or less and are not certificated to EASA CS–23 or CS–25, or equivalent, sources of general cabin illumination.
- (b) The operator shall not, by night, operate a passenger carrying aeroplane which has a maximum approved passenger seating configuration of 9 or less unless it is provided with a source of general cabin illumination to facilitate the evacuation of the aeroplane. The system may use dome lights or other sources of illumination already fitted on the aeroplane and which are capable of remaining operative after the aeroplane's battery has been switched off.

OPS 1.817 Electronic Flight Bag (EFB) Equipment

- (a) Where portable EFBs are used on board, the operator shall ensure that they do not affect the performance of the aeroplane systems, equipment or the ability to operate the aeroplane.
- (b) Where EFBs are used on board an aeroplane the operator shall:
 - (1) assess the safety risk(s) associated with each EFB function;
 - (2) establish and document the procedures for the use of, and training requirements for, the device and each EFB function; and
 - (3) ensure that, in the event of an EFB failure, sufficient information is readily available to the flight crew for the flight to be conducted safely.
- (c) The Authority, as the State of the Operator, shall issue a specific approval for the operational use of EFB functions to be used for the safe operations of aeroplanes. When issuing a specific approval for the operational use of EFBs, the Authority shall ensure that:



- (1) the EFB equipment and its associated installation hardware, including interaction with aeroplane systems if applicable, meet the appropriate airworthiness certification requirements;
- (2) the operator has assessed the safety risks associated with the operations supported by the EFB function(s);
- (3) the operator has established requirements for redundancy of the information (if appropriate) contained and displayed by the EFB function(s);
- (4) the operator has established and documented procedures for the management of the EFB function(s) including any databases it may use; and
- (5) the operator has established and documented the procedures for the use of, and training requirements for, the EFB, the EFB function(s).

Note: Guidance on EFB equipment, functions and operational approval is contained in the Manual on Electronic Flight Bags (Doc 10020).

OPS 1.820 Emergency Locator Transmitter

(See AC OPS 1.820)

- (a) All aeroplanes authorised to carry more than 19 passengers for which the individual certificate of airworthiness is first issued after 01 July 2008 shall be equipped with either;
 - (1) At least two ELTs, one of which shall be automatic; or
 - (2) at least one ELT and a capability that meets the requirements of OPS 1.821

Note: In the case where the requirements for OPS 1.821 are met by another system no automatic ELT is required. (See AMC OPS 1.820)

- (b) The operator shall not operate an aeroplane authorised to carry 19 passengers or less unless it is equipped with at least:
 - (1) one ELT of any type; or
 - (2) one automatic ELT for aeroplanes first issued with an individual certificate of airworthiness after 1 July 2008.
- (c) The operator shall ensure that all ELTs carried to satisfy the above requirements operate in accordance with the relevant provisions of ICAO Annex 10, Volume III.

OPS 1.821 Location of an Aeroplane in Distress

(See AC OPS 1.821)

- (a) As of 01 January 2025, all aeroplanes of a maximum certificated take-off mass of over 27000 kg for which the individual certificate of airworthiness is first issued on or after 01 January 2024, shall autonomously transmit information from which a position can be determined by the operator at least once every minute, when in distress. (See AC OPS 1.821).
- (b) All aeroplanes of a maximum certificated take-off mass of over 5700 kg for which the individual certificate of airworthiness is first issued on or after 01 January 2023, should autonomously transmit information from which a position can be determined at least once every minute, when in distress.



(See AC OPS 1.821).

- (c) The operator shall make position information of a flight in distress available to the appropriate organisations, as established by the Authority.

OPS 1.825 Life Jackets

(See AMC OPS 1.825)

- (a) *Land aeroplanes.* the operator shall not operate a land aeroplane:
- (1) with two or more engines when flying over water and at a distance of more than 50 nautical miles from the shore for those aeroplanes that meet the applicable enroute performance requirements of Subparts G, H or I; or
 - (2) when flying en route over water beyond gliding distance from the shore, in the case of all other landplanes; and
 - (3) when taking off or landing at an aerodrome where the take-off or approach path is so disposed over water that in the event of a mishap there would be a likelihood of a ditching,

unless it is equipped with life jackets equipped with a survivor locator light, for each person on board. Each life jacket must be stowed in a position easily accessible from the seat or berth of the person for whose use it is provided. Life jackets for infants may be substituted by other approved flotation devices equipped with a survivor locator light.

Note 1: "Landplanes" includes amphibians operated as landplanes.

Note 2: Life jackets accessible from seats or berths located in crew rest compartments are required only if the seats or berths concerned are certified to be occupied during take-off and landing.

- (b) *Seaplanes and amphibians.* the operator shall not operate a seaplane or an amphibian on water unless it is equipped with life jackets equipped with a survivor locator light, for each person on board. Each life jacket must be stowed in a position easily accessible from the seat or berth of the person for whose use it is provided. Life jackets for infants may be substituted by other approved flotation devices equipped with a survivor locator light.

OPS 1.830 Life-Rafts and Survival ELTs for Extended Overwater Flights

- (a) On overwater flights, the operator shall not operate an aeroplane at a distance away from land, which is suitable for making an emergency landing, greater than that corresponding to:
- (1) 120 minutes at cruising speed or 400 nautical miles, whichever is the lesser, for aeroplanes capable of continuing the flight to an aerodrome with the critical power unit(s) becoming inoperative at any point along the route or planned diversions; or
 - (2) 30 minutes at cruising speed or 100 nautical miles, whichever is the lesser, for all other aeroplanes,

unless the equipment specified in sub-paragraphs (b), (c) and (d) below is carried.



- (b) Sufficient life-rafts to carry all persons on board. Unless excess rafts of enough capacity are provided, the buoyancy and seating capacity beyond the rated capacity of the rafts must accommodate all occupants of the aeroplane in the event of a loss of one raft of the largest rated capacity. The life-rafts shall be equipped with:
 - (1) a survivor locator light; and
 - (2) life saving equipment including means of sustaining life as appropriate to the flight to be undertaken (see AMC OPS 1.830(b)(2));
- (c) At least two survival Emergency Locator Transmitters (ELT(S)) capable of transmitting on the distress frequencies prescribed in ICAO Annex 10, Volume V, Chapter 2 (See AC OPS 1.820.); and
- (d) At the earliest practicable date but not later than 01 January 2019, on all aeroplanes of a maximum certificated take-off mass of over 27000 kg, a securely attached underwater locating device operating at a frequency of 8.8 kHz. This automatically activated underwater locating device shall operate for a minimum of 30 days and shall not be installed in wings or empennage.

OPS 1.835 Survival Equipment

(See AMC OPS 1.835)

The operator shall not operate an aeroplane across areas in which search and rescue would be especially difficult unless it is equipped with the following:

- (a) Signalling equipment to make the pyrotechnical distress signals described in ICAO Annex 2;
- (b) At least one ELT(S) capable of transmitting on the distress frequencies prescribed in ICAO Annex 10, Volume V, Chapter 2 (See AC OPS 1.820); and
- (c) Additional survival equipment for the route to be flown taking account of the number of persons on board (See AMC OPS 1.835(c)), except that the equipment specified in sub-paragraph (c) need not be carried when the aeroplane either:
 - (1) remains within a distance from an area where search and rescue is not especially difficult corresponding to:
 - (i) 120 minutes at the one-engine-inoperative cruising speed for aeroplanes capable of continuing the flight to an aerodrome with the critical power unit(s) becoming inoperative at any point along the route or planned diversions; or
 - (ii) 30 minutes at cruising speed for all other aeroplanes,
 - or,
 - (2) for aeroplanes certificated to EASA CS-25 or equivalent, no greater distance than that corresponding to 90 minutes at cruising speed from an area suitable for making an emergency landing.

OPS 1.840 Seaplanes and amphibians – Miscellaneous equipment

- (a) The operator shall not operate a seaplane or an amphibian on water unless it is equipped with:



- (1) A sea anchor and other equipment necessary to facilitate mooring, anchoring or manoeuvring the aircraft on water, appropriate to its size, weight and handling characteristics; and
- (2) Equipment for making the sound signals prescribed in the International Regulations for Preventing Collisions at Sea, where applicable.

OPS 1.842 Additional Requirements for Operations of Single-engine Turbine-powered Aeroplanes at Night and/or in Instrument Meteorological Conditions (IMC)

(See OPS 1.526)

(See AMC OPS 1.526)

- (a) All single-engine turbine-powered aeroplanes operated at night and/or in IMC shall have an engine trend monitoring system, and those aeroplanes for which the individual certificate of airworthiness is first issued on or after 01 January 2005 shall have an automatic trend monitoring.
- (b) To minimize the probability of in-flight engine failure, the engine shall be equipped with:
 - (1) an ignition system that activates automatically, or is capable of being operated manually, for take-off and landing, and during flight, in visible moisture;
 - (2) a magnetic particle detection or equivalent system that monitors the engine, accessories gearbox, and reduction gearbox, and which includes a flight deck caution indication; and
 - (3) an emergency engine power control device that permits continuing operation of the engine through a sufficient power range to safely complete the flight in the event of any reasonably probable failure of the fuel control unit.
- (c) Single-engine turbine-powered aeroplanes approved to operate at night and/or in IMC shall be equipped with the following systems and equipment intended to ensure continued safe flight and to assist in achieving a safe forced landing after an engine failure, under all allowable operating conditions:
 - (1) two separate electrical generating systems, each one capable of supplying all probable combinations of continuous in-flight electrical loads for instruments, equipment and systems required at night and/or in IMC;
 - (2) a radio altimeter;
 - (3) an emergency electrical supply system of sufficient capacity and endurance, following loss of all generated power, to as a minimum:
 - (i) maintain the operation of all essential flight instruments, communication and navigation systems during a descent from the maximum certificated altitude in a glide configuration to the completion of a landing;
 - (ii) lower the flaps and landing gear, if applicable;
 - (iii) provide power to one pitot heater, which must serve an air speed indicator clearly visible to the pilot;
 - (iv) provide for operation of the landing light;
 - (v) provide for one engine restart, if applicable; and



- (vi) provide for the operation of the radio altimeter;
- (4) two attitude indicators, powered from independent sources;
- (5) a means to provide for at least one attempt at engine start;
- (6) airborne weather radar;
- (7) a certified area navigation system capable of being programmed with the positions of aerodromes and safe forced landing areas, and providing instantly available track and distance information to those locations;
- (8) for passenger operations, passenger seats and mounts which meet dynamically-tested performance standards and which are fitted with a shoulder harness or a safety belt with a diagonal shoulder strap for each passenger seat;
- (9) in pressurised aeroplanes, sufficient supplemental oxygen for all occupants for descent following engine failure at the maximum glide performance from the maximum certificated altitude to an altitude at which supplemental oxygen is no longer required;
- (10) a landing light that is independent of the landing gear and is capable of adequately illuminating the touchdown area in a night forced landing; and
- (11) an engine fire warning system.

**Appendix 1 to OPS 1.700****Cockpit Voice Recorder (CVR) and Cockpit Audio Recording System (CARS)****(a) Start and stop logic**

The CVR or CARS shall start to record prior to the aeroplane moving under its own power and record continuously until the termination of the flight when the aeroplane is no longer capable of moving under its own power. In addition, depending on the availability of electrical power, the CVR or CARS shall start to record as early as possible during the cockpit checks prior to engine start at the beginning of the flight until the cockpit checks immediately following engine shutdown at the end of the flight.

(b) Signals to be recorded

- (1) The CVR shall record simultaneously on four separate channels, or more, at least the following:
 - (i) voice communication transmitted from or received in the aeroplane by radio;
 - (ii) aural environment on the flight deck;
 - (iii) voice communication of flight crew members on the flight deck using the aeroplane's interphone system, if installed;
 - (iv) voice or audio signals identifying navigation or approach aids introduced in the headset or speaker; and
 - (v) voice communication of flight crew members using the passenger address system, if installed.

(c) The preferred CVR audio allocation should be as follows:

- (1) pilot-in-command audio panel;
- (2) co-pilot audio panel;
- (3) additional flight crew positions and time reference; and
- (4) cockpit area microphone.

(d) The CARS shall record simultaneously on two separate channels, or more, at least the following:

- (1) voice communication transmitted from or received in the aeroplane by radio;
- (2) aural environment on the flight deck; and
- (3) voice communication of flight crew members on the flight deck using the aeroplane's interphone system, if installed.

(e) The preferred CARS audio allocation should be as follows:

- (1) voice communication; and



- (2) aural environment on the flight deck.



Appendix 1 to OPS 1.700/OPS 1.710/OPS 1.715 Flight Recorders - General

Note 1: The following applies to all crash protected flight recorders which comprise one or more of the following:

- (1) a flight data recorder (FDR),
- (2) a cockpit voice recorder (CVR)
- (3) an airborne image recorder (AIR),
- (4) a data link recorder (DLR).

When image or data link information is required to be recorded on a crash-protected flight recorder, it is permissible to record it on either the CVR or the FDR.

Note 2: The following applies to all lightweight flight recorders which comprise one or more of the following:

- (1) an aircraft data recording system (ADRS),
- (2) a cockpit audio recording system (CARS),
- (3) an airborne image recording system (AIRS)
- (4) a data link recording system (DLRS).

When image or data link information is required to be recorded on a lightweight flight recorder, it is permissible to record it on either the CARS or the ADRS.

- (a) Non-deployable flight recorder containers shall be painted a distinctive orange colour;
- (b) Non-deployable crash protected flight recorder containers shall;
 - (1) carry reflective material to facilitate their location; and
 - (2) have a device to assist in locating that recorder in water and, not later than 01 January, 2019, have securely attached an automatically activated underwater locating device operating at a frequency of 37.5 kHz that operates for a minimum of 90 days.
- (c) Automatic deployable flight recorder containers shall:
 - (1) be painted a distinctive orange colour, however the surface visible from outside the aircraft may be of another colour;
 - (2) carry reflective material to facilitate their location; and
 - (3) have an integrated automatically activated ELT.
- (d) The flight recorder systems shall be installed so that:
 - (1) the probability of damage to the recordings is minimized;



- (2) there is an aural or visual means for pre-flight checking that the flight recorder systems are operating properly; and
- (3) if the flight recorder systems have an erasure device, the installation shall be designed to prevent operation of the device during flight time or crash impact; and
- (4) for aeroplanes for which the individual certificate of airworthiness is first issued on or after 01 January 2023, a flight crew-operated erase function shall be provided on the flight deck which, when activated, modifies the recording of a CVR and AIR so that it cannot be retrieved using normal replay or copying techniques. The installation shall be designed to prevent activation during flight. In addition, the probability of an inadvertent activation of an erase function during an accident shall also be minimised.

Note: The erase function is intended to prevent access to CVR and AIR recordings by normal replay or copying means, but would not prevent accident investigation authorities access to such recordings by specialised replay or copying techniques.

- (e) The crash-protected flight recorders shall be installed so that they receive electrical power from a bus that provides the maximum reliability for operation of the flight recorders without jeopardizing service to essential or emergency loads.
- (f) The lightweight flight recorders shall be connected to a power source having the characteristics which ensure proper and reliable recording in the operational environment.
- (g) The flight recorder systems, when tested by methods approved by the appropriate certifying authority, shall be demonstrated to be suitable for the environmental extremes over which they are designed to operate.
- (h) Means shall be provided for an accurate time correlation between the flight recorder systems recordings.
- (i) The flight recorder system manufacturer shall provide the appropriate certifying authority with the following information in respect of the flight recorder systems:
 - (1) manufacturer's operating instructions, equipment limitations and installation procedures;
 - (2) parameter origin or source and equations which relate counts to units of measurement;
 - (3) manufacturer's test reports; and
 - (4) detailed information to ensure the continued serviceability of the flight recorder system.
- (j) The holder of the airworthiness approval for the installation design of the flight recorder system shall make available the relevant continuing airworthiness information to the operator of the aeroplane to be incorporated in the continuing airworthiness maintenance programme. This continuing airworthiness information shall cover in detail all the tasks required to ensure the continued serviceability of the flight recorder system.

Note: The flight recorder system is composed of the flight recorder as well as any dedicated sensors, hardware and software that provide information required under this Appendix.



- (k) Flight recorders shall be constructed, located and installed so as to provide maximum practical protection for the recordings in order that the recorded information may be preserved, recovered and transcribed. Flight recorders shall meet the prescribed crashworthiness and fire protection specifications.
- (l) All aeroplanes of a maximum certificated take-off mass of over 27000 kg and authorised to carry more than nineteen passengers for which the application for type certification is submitted to a Contracting State on or after 01 January 2021, shall be equipped with a means approved by the Authority, to recover flight recorder data and make it available in a timely manner.
- (m) In approving the means to make flight recorder data available in a timely manner, the Authority shall take into account the following;
 - (1) the capabilities of the operator;
 - (2) overall capability of the aeroplane and its systems as certified by the State of Design;
 - (3) the reliability of the means to recover the appropriate CVR channels and appropriate FDR data; and
 - (4) specific mitigation measures.



Appendix 2 to OPS 1.700/OPS 1.710/OPS 1.715

Inspection of Flight Recorder Systems

- (a) Prior to the first flight of the day, the built-in test features for the flight recorders and flight data acquisition unit (FDAU), when installed, shall be monitored by manual and/or automatic checks.
- (b) FDR systems or ADRS, CVR systems or CARS, and AIR systems or AIRS shall have recording inspection intervals of one year. This period may be extended by the Authority to two years provided these systems have demonstrated a high integrity of serviceability and self-monitoring.
- (c) DLR systems or DLRS shall have recording inspection intervals of two years. This period may be extended by the Authority to four years provided these systems have demonstrated a high integrity of serviceability and self-monitoring.
- (d) Recording inspections shall be carried out as follows:
 - (1) an analysis of the recorded data from the flight recorders shall ensure that the recorder operates correctly for the nominal duration of the recording;
 - (2) the FDR or ADRS recording from a complete flight shall be examined in engineering units to evaluate the validity of all recorded parameters. Particular attention shall be given to parameters from sensors dedicated to the FDR or ADRS. Parameters taken from the aircraft's electrical bus system need not be checked if their serviceability can be detected by other aircraft systems;
 - (3) the readout facility shall have the necessary software to accurately convert the recorded values to engineering units and to determine the status of discrete signals;
 - (4) an annual examination of the recorded signal on the CVR or CARS shall be carried out by replay of the CVR or CARS recording. While installed in the aircraft, the CVR or CARS shall record test signals from each aircraft source and from relevant external sources to ensure that all required signals meet intelligibility standards;
 - (5) where practicable, during the examination, a sample of in-flight recordings of the CVR or CARS shall be examined for evidence that the intelligibility of the signal is acceptable; and
 - (6) an examination of the recorded images on the AIR or AIRS shall be carried out by replay of the AIR or AIRS recording. While installed in the aircraft, the AIR or AIRS shall record test images from each aircraft source and from relevant external sources to ensure that all required images meet recording quality standards.
 - (7) an examination of the recorded messages on the DLR or DLRS shall be carried out by replay of the DLR or DLRS recording.
- (e) A flight recorder system shall be considered unserviceable if there is a significant period of poor quality data, unintelligible signals, or if one or more of the mandatory parameters is not recorded correctly.
- (f) A report of the recording inspection shall be made available on request to regulatory authorities for monitoring purposes.
- (g) Calibration of the FDR system:



- (1) for those parameters which have sensors dedicated only to the FDR and are not checked by other means, recalibration shall be carried at an interval determined by the continuing airworthiness information for the FDR system. In the absence of such information, a recalibration shall be carried out at least every five years. The recalibration shall determine any discrepancies in the engineering conversion routines for the mandatory parameters and to ensure that parameters are being recorded within the calibration tolerances; and
- (2) when the parameters of altitude and airspeed are provided by sensors that are dedicated to the FDR system, there shall be a recalibration performed at an interval determined by the continuing airworthiness information for the FDR system. In the absence of such information, a recalibration shall be carried out at least every two years.



Appendix 1 to OPS 1.710/OPS 1.715 Flight Data Recorder (FDR) and Aircraft Data Recording Systems (ADRS)

(a) Start and Stop Logic

The FDR or ADRS shall start to record prior to the aeroplane moving under its own power and record continuously until the termination of the flight when the aeroplane is no longer capable of moving under its own power.

(b) Parameters to be Recorded

- (1) The parameters that satisfy the requirements for FDRs are listed in the paragraphs below in Appendix 3 to OPS 1.710/OPS 1.715. The number of parameters to be recorded shall depend on aeroplane complexity. The parameters without an asterisk (*) are mandatory parameters which shall be recorded regardless of aeroplane complexity. In addition, the parameters designated by an asterisk (*) shall be recorded if an information data source for the parameter is used by aeroplane systems or the flight crew to operate the aeroplane. However, other parameters may be substituted with due regard to the aeroplane type and the characteristics of the recording equipment.
- (2) If further FDR recording capacity is available, recording of the following additional information shall be considered:
 - (i) operational information from electronic display systems, such as electronic flight instrument systems (EFIS), electronic centralized aircraft monitor (ECAM) and engine indication and crew alerting system (EICAS). Use the following order of priority:
 - (A) parameters selected by the flight crew relating to the desired flight path, e.g. barometric pressure setting, selected altitude, selected airspeed, decision height, and autoflight system engagement and mode indications if not recorded from another source;
 - (B) display system selection/status, e.g. SECTOR, PLAN, ROSE, NAV, WXR, COMPOSITE, COPY, ETC.;
 - (C) warnings and alerts; and
 - (D) the identity of displayed pages for emergency procedures and checklists; and
 - (ii) retardation information including brake application for use in the investigation of landing overruns and rejected take-offs.
- (3) The parameters that satisfy the requirements for flight path and speed as displayed to the pilot(s) are listed below. The parameters without an (*) are mandatory parameters which shall be recorded. In addition, the parameters designated by an (*) shall be recorded if an information source for the parameter is displayed to the pilot and is practicable to record:
 - Pressure altitude
 - Indicated airspeed or calibrated airspeed
 - Heading (primary flight crew reference)
 - Pitch attitude
 - Roll attitude



- Engine thrust/power
 - Landing-gear status*
 - Total or outside air temperature*
 - Time*
 - Navigation data*: drift angle, wind speed, wind direction, latitude/longitude
 - Radio altitude*
- (4) The parameters that satisfy the requirements for ADRS are the first 7 parameters listed in Appendix 2 to OPS 1.710.
- (5) If further ADRS recording capacity is available, the recording of any parameters from 8 onwards listed in Appendix 2 to OPS 1.710 shall be considered.
- (c) Additional Information
- (1) The measurement range, recording interval and accuracy of parameters on installed equipment shall be verified by methods approved by the appropriate certificating authority.
- (2) Documentation concerning parameter allocation, conversion equations, periodic calibration and other serviceability/maintenance information shall be maintained by the operator. The documentation needs to be sufficient to ensure that accident investigation authorities have the necessary information to read out the data in engineering units.



Appendix 2 to OPS 1.710/OPS 1.715 Data Link Recorder (DLR) Applications to be Recorded

- (a) Where the aircraft flight path is authorised or controlled through the use of data link messages, all data link messages, both uplinks (to the aircraft) and downlinks (from the aircraft), shall be recorded on the aircraft. As far as practicable, the time the messages were displayed to the flight crew and the time of the responses shall be recorded.

Note: Sufficient information to derive the content of the data link communications message and the time the messages were displayed to the flight crew is needed to determine an accurate sequence of events on board the aircraft.

- (b) Messages applying to the applications listed below shall be recorded. Applications without the asterisk (*) are mandatory applications which shall be recorded regardless of the system complexity. Applications with an (*) shall be recorded only as far as is practicable given the architecture of the system.

Item No.	Application type	Application description	Recording content
1	Data link initiation	This includes any applications used to log on to or initiate data link service. In FANS-1/A and ATN, these are ATS facilities notification (AFN) and context management (CM) respectively.	C
2	Controller/pilot communication	This includes any application used to exchange requests, clearances, instructions and reports between the flight crew and controllers on the ground. In FANS-1/A and ATN, this includes the CPDLC application. It also includes applications used for the exchange of oceanic (OCL) and departure clearances (DCL) as well as data link delivery of taxi clearances.	C
3	Addressed surveillance	This includes any surveillance application in which the ground sets up contracts for delivery of surveillance data. In FANS-1/A and ATN, this includes the automatic dependent surveillance — contract (ADS-C) application. Where parametric data are reported within the message they shall be recorded unless data from the same source are recorded on the FDR.	C
4	Flight information	This includes any service used for delivery of flight information to specific aircraft. This includes, for example, data link aviation weather report service (D-METAR), data link-automatic terminal service (D-ATIS), digital Notice to Airmen (D-NOTAM) and other textual data link services.	C
5	Aircraft broadcast surveillance	This includes elementary and enhanced surveillance systems, as well as automatic dependent surveillance — broadcast (ADS-B) output data. Where parametric data sent by the aeroplane are reported within the message they shall be recorded unless data from the same source are recorded on the FDR.	M*
6	Aeronautical operational control data	This includes any application transmitting or receiving data used for aeronautical operational control purposes (per the ICAO definition of operational control).	M*

Key:

C: Complete contents recorded.

M: Information that enables correlation to any associated records stored separately from the aeroplane.

*: Applications to be recorded only as far as is practicable given the architecture of the system.



Appendix 3 to OPS 1.710/1.715 Parameter Characteristics for Flight Data Recorders

Serial number	Parameter	Applicability	Measurement range	Maximum sampling and recording interval (seconds)	Accuracy limits (sensor input compared to FDR readout)	Recording resolution
1	Time (UTC when available, otherwise relative time count or -GNSS time sync)		24 hours	4	±0.125%/h	1 s
2	Pressure-altitude		-300 m (-1 000 ft) to maximum certificated altitude of aircraft +1 500 m (+5 000 ft)	1	±30 m to ±200 m (±100 ft to ±700 ft)	1.5 m (5 ft)
3	Indicated airspeed or calibrated airspeed		95 km/h (50 kt) to max V_{S0} (Note 1) V_{S0} to 1.2 V_D (Note 2)	1	±5% ±3%	1 kt (0.5 kt recommended)
4	Heading (primary flight crew reference)		360°	1	±2°	0.5°
5	Normal acceleration (Note 8)	Application for type certification is submitted to a Contracting State before 1 January 2016	-3 g to +6 g	0.125	±1% of maximum range excluding datum error of ±5%	0.004 g
		Application for type certification is submitted to a Contracting State on or after 1 January 2016	-3 g to +6 g	0.0625	±1% of maximum range excluding datum error of ±5%	0.004 g
6	Pitch attitude		±75° or usable range whichever is greater	0.25	±2°	0.5°
7	Roll attitude		±180°	0.25	±2°	0.5°
8	Radio transmission keying		On-off (one discrete)	1		



Serial number	Parameter	Applicability	Measurement range	Maximum sampling and recording interval (seconds)	Accuracy limits (sensor input compared to FDR readout)	Recording resolution
9	Power on each engine (Note 3)		Full range	1 (per engine)	±2%	0.2% of full range or the resolution required to operate the aircraft
10*	Trailing edge flap and cockpit control selection		Full range or each discrete position	2	±5% or as pilot's indicator	0.5% of full range or the resolution required to operate the aircraft
11*	Leading edge flap and cockpit control selection		Full range or each discrete position	2	±5% or as pilot's indicator	0.5% of full range or the resolution required to operate the aircraft
12*	Thrust reverser position		Stowed, in transit, and reverse	1 (per engine)		
13*	Ground spoiler/speed brake selection (selection and position)		Full range or each discrete position	1	±2% unless higher accuracy uniquely required	0.2% of full range
14	Outside air temperature		Sensor range	2	±2°C	0.3°C
15*	Autopilot/auto throttle/AFCS mode and engagement status		A suitable combination of discretises	1		
16	Longitudinal acceleration (Note 8)	Application for type certification submitted to a Contracting State before 1 January 2016	±1 g	0.25	±0.015 g excluding a datum error of ±0.05 g	0.004 g
		Application for type certification submitted to a Contracting State on or after 1 January 2016	±1 g	0.0625	±0.015 g excluding a datum error of ±0.05 g	0.004 g
17	Lateral acceleration (Note 8)	Application for type certification submitted to a Contracting State before 1 January 2016	±1 g	0.25	±0.015 g excluding a datum error of ±0.05 g	0.004 g
		Application for type certification submitted to a Contracting State on or after 1 January 2016	±1 g	0.0625	±0.015 g excluding a datum error of ±0.05 g	0.004 g



Serial number	Parameter	Applicability	Measurement range	Maximum sampling and recording interval (seconds)	Accuracy limits (sensor input compared to FDR readout)	Recording resolution
18	Pilot input and/or control surface position-primary controls (pitch, roll, yaw) (Notes 4 and 8)	Application for type certification submitted to a Contracting State before 1 January 2016	Full range	0.25	$\pm 2^\circ$ unless higher accuracy uniquely required	0.2% of full range or as installed
		Application for type certification submitted to a Contracting State on or after 1 January 2016	Full range	0.125	$\pm 2^\circ$ unless higher accuracy uniquely required	0.2% of full range or as installed
19	Pitch trim position		Full range	1	$\pm 3\%$ unless higher accuracy uniquely required	0.3% of full range or as installed
20*	Radio altitude		-6 m to 750 m (-20 ft to 2 500 ft)	1	± 0.6 m (± 2 ft) or $\pm 3\%$ whichever is greater below 150 m (500 ft) and $\pm 5\%$ above 150 m (500 ft)	0.3 m (1 ft) below 150 m (500 ft) 0.3 m (1 ft) + 0.5% of full range above 150 m (500 ft)
21*	Vertical beam deviation (ILS/GNSS/GLS glide path, MLS elevation, IRNAV/IAN vertical deviation)		Signal range	1	$\pm 3\%$	0.3% of full range
22*	Horizontal beam deviation (ILS/GNSS/GLS localizer, MLS azimuth, IRNAV/IAN lateral deviation)		Signal range	1	$\pm 3\%$	0.3% of full range
23	Marker beacon passage		Discrete	1		
24	Master warning		Discrete	1		
25	Each NAV receiver frequency selection (Note 5)		Full range	4	As installed	



Serial number	Parameter	Applicability	Measurement range	Maximum sampling and recording interval (seconds)	Accuracy limits (sensor input compared to FDR readout)	Recording resolution
26*	DME 1 and 2 distance (includes Distance to runway threshold (GLS) and Distance to missed approach point (IRNAV/IAN)) (Notes 5 and 6)		0 – 370 km (0 – 200 NM)	4	As installed	1 852 m (1 NM)
27	Air/ground status		Discrete	1		
28*	GPWS/TAWS/GCAS status (selection of terrain display mode including pop-up display status) and (terrain alerts, both cautions and warnings, and advisories) and (on/off switch position)		Discrete	1		
29*	Angle of attack		Full range	0.5	As installed	0.3 % of full range
30*	Hydraulics, each system (low pressure)		Discrete	2		0.5% of full range
31*	Navigation data (latitude/longitude, ground speed and drift angle) (Note 7)		As installed	1	As installed	
32*	Landing gear and gear selector position		Discrete	4	As installed	
33*	Groundspeed		As installed	1	Data should be obtained from the most accurate system	1 kt
34	Brakes (left and right brake pressure, left and right brake pedal position)		(Maximum metered brake range, discretised or full range)	1	±5%	2% of full range



Serial number	Parameter	Applicability	Measurement range	Maximum sampling and recording interval (seconds)	Accuracy limits (sensor input compared to FDR readout)	Recording resolution
35*	Additional engine parameters (EPR, N_1 , indicated vibration level, N_2 , EGT, fuel flow, fuel cut-off lever position, N_3 , engine fuel metering valve position)	Engine fuel metering valve position: Application for type certification is submitted to a Contracting State on or after 1 January 2023	As installed	Each engine each second	As installed	2% of full range
36*	TCAS/ACAS (traffic alert and collision avoidance system)		Discretes	1	As installed	
37*	Wind shear warning		Discrete	1	As installed	
38*	Selected barometric setting (pilot, co-pilot)		As installed	64	As installed	0.1 mb (0.01 in-Hg)
39*	Selected altitude (all pilot selectable modes of operation)		As installed	1	As installed	Sufficient to determine crew selection
40*	Selected speed (all pilot selectable modes of operation)		As installed	1	As installed	Sufficient to determine crew selection
41*	Selected Mach (all pilot selectable modes of operation)		As installed	1	As installed	Sufficient to determine crew selection
42*	Selected vertical speed (all pilot selectable modes of operation)		As installed	1	As installed	Sufficient to determine crew selection
43*	Selected heading (all pilot selectable modes of operation)		As installed	1	As installed	Sufficient to determine crew selection
44*	Selected flight path (all pilot selectable modes of operation) (course/DSTRK, path angle, final approach path (IRNAV/IAN))			1	As installed	
45*	Selected decision height		As installed	64	As installed	Sufficient to determine crew selection
46*	EFIS display format (pilot, co-pilot)		Discrete(s)	4	As installed	
47*	Multi-function/engine/alerts display format		Discrete(s)	4	As installed	
48*	AC electrical bus status		Discrete(s)	4	As installed	



Serial number	Parameter	Applicability	Measurement range	Maximum sampling and recording interval (seconds)	Accuracy limits (sensor input compared to FDR readout)	Recording resolution
49*	DC electrical bus status		Discrete(s)	4	As installed	
50*	Engine bleed valve position		Discrete(s)	4	As installed	
51*	APU bleed valve position		Discrete(s)	4	As installed	
52*	Computer failure		Discrete(s)	4	As installed	
53*	Engine thrust command		As installed	2	As installed	
54*	Engine thrust target		As installed	4	As installed	2% of full range
55*	Computed centre of gravity		As installed	64	As installed	1% of full range
56*	Fuel quantity in CG trim tank		As installed	64	As installed	1% of full range
57*	Head up display in use		As installed	4	As installed	
58*	Para visual display on/off		As installed	1	As installed	
59*	Operational stall protection, stick shaker and pusher activation		As installed	1	As installed	
60*	Primary navigation system reference (GNSS, INS, VOR/DME, MLS, Loran C, localizer glideslope)		As installed	4	As installed	
61*	Ice detection		As installed	4	As installed	
62*	Engine warning each engine vibration		As installed	1	As installed	
63*	Engine warning each engine over temperature		As installed	1	As installed	
64*	Engine warning each engine oil pressure low		As installed	1	As installed	
65*	Engine warning each engine over speed		As installed	1	As installed	
66*	Yaw trim surface position		Full range	2	±3% unless higher accuracy uniquely required	0.3% of full range



Serial number	Parameter	Applicability	Measurement range	Maximum sampling and recording interval (seconds)	Accuracy limits (sensor input compared to FDR readout)	Recording resolution
67*	Roll trim surface position		Full range	2	±3% unless higher accuracy uniquely required	0.3% of full range
68*	Yaw or sideslip angle		Full range	1	±5%	0.5°
69*	De-icing and/or anti-icing systems selection		Discrete(s)	4		
70*	Hydraulic pressure (each system)		Full range	2	±5%	100 psi
71*	Loss of cabin pressure		Discrete	1		
72*	Cockpit trim control input position, Pitch		Full range	1	±5%	0.2% of full range or as installed
73*	Cockpit trim control input position, Roll		Full range	1	±5%	0.2% of full range or as installed
74*	Cockpit trim control input position, Yaw		Full range	1	±5%	0.2% of full range or as installed
75*	All cockpit flight control input forces (control wheel, control column, rudder pedal)		Full range (±311 N (±70 lbf), ± 378 N (±85 lbf), ± 734 N (±165 lbf))	1	±5%	0.2% of full range or as installed
76*	Event marker		Discrete	1		
77*	Date		365 days	64		
78*	ANP or EPE or EPU		As installed	4	As installed	
79*	Cabin pressure altitude	Application for type certification submitted to a Contracting State on or after 1 January 2023	As installed (0 ft to 40 000 ft recommended)	1	As installed	100 ft
80*	Aeroplane computed weight	Application for type certification submitted to a Contracting State on or after 1 January 2023	As installed	64	As installed	1% of full range
81*	Flight director command	Application for type certification submitted to a Contracting State on or after 1 January 2023	Full range	1	± 2°	0.5°
82*	Vertical speed	Application for type certification submitted to a Contracting State on or after 1 January 2023	As installed	0.25	As installed (32 ft/min recommended)	16 ft/min



Notes.—

1. V_{S0} stalling speed or minimum steady flight speed in the landing configuration is in Section “Abbreviations and Symbols”.
2. V_D design diving speed.
3. Record sufficient inputs to determine power.
4. For aeroplanes with control systems in which movement of a control surface will back drive the pilot’s control, “or” applies. For aeroplanes with control systems in which movement of a control surface will not back drive the pilot’s control, “and” applies. In aeroplanes with split surfaces, a suitable combination of inputs is acceptable in lieu of recording each surface separately. In aeroplanes with independent pilot input on primary controls, each pilot input on primary controls needs to be recorded separately.
5. If signal available in digital form.
6. Recording of latitude and longitude from INS or other navigation system is a preferred alternative.
7. If signals readily available.
8. It is not intended that aeroplanes issued with an individual certificate of airworthiness before 1 January 2016 be modified to meet the measurement range, maximum sampling and recording interval, accuracy limits or recording resolution description detailed in this Appendix.



Appendix 1 to OPS 1.710 Flight Crew – Machine Interface Recordings

(a) Start and Stop Logic

The AIR or AIRS shall start to record prior to the aeroplane moving under its own power and record continuously until the termination of the flight when the aeroplane is no longer capable of moving under its own power. In addition, depending on the availability of electrical power, the AIR or AIRS shall start to record as early as possible during the cockpit checks prior to engine start at the beginning of the flight until the cockpit checks immediately following engine shutdown at the end of the flight.

(b) Classes

- (1) A Class A AIR or AIRS captures the general cockpit area in order to provide data supplemental to conventional flight recorders.

Note 1: To respect crew privacy, the cockpit area view may be designed as far as practical to exclude the head and shoulders of crew members whilst seated in their normal operating position.

Note 2: There are no provisions for Class A AIR or AIRS in this document.

- (2) A Class B AIR or AIRS captures data link message displays.
- (3) A Class C AIR or AIRS captures instruments and control panels.

Note: A Class C AIR or AIRS may be considered as a means for recording flight data where it is not practical or is prohibitively expensive to record on an FDR or an ADRS, or where an FDR is not required.

(c) Applications to be recorded

- (1) The operation of switches and selectors and the information displayed to the flight crew from electronic displays shall be captured by sensors or other electronic means.
- (2) The recording of operation of switches and selectors by the flight crew shall include the following:
 - any switch or selector that will affect the operation and the navigation of the aircraft; and
 - selection of normal and alternate systems.
- (3) The recording of the information displayed to the flight crew from electronic displays shall include the following:
 - primary flight and navigation displays;
 - aircraft system monitoring displays;
 - engine indication displays;
 - traffic, terrain, and weather displays;
 - crew alerting systems displays;
 - stand-by instruments; and



— installed EFB to the extent it is practical.

(4) If image sensors are used, the recording of such images shall not capture the head and shoulders of the flight crew members whilst seated in their normal operating position.

(d) Duration

The minimum flight crew-machine interface recording duration shall be at least for the last two hours.

(e) Correlation

Flight crew-machine interface recordings shall be able to be correlated to the recorded cockpit audio.



Appendix 2 to OPS 1.710 Parameter Characteristics for Aircraft Data Recording Systems (ADRS)

No.	Parameter name	Minimum recording range	Maximum recording interval in seconds	Minimum recording accuracy	Minimum recording resolution	Remarks
1	Heading					
	a) Heading (Magnetic or True)	±180°	1	±2°	0.5°	Heading is preferred, if not available, yaw rate shall be recorded
	b) Yaw rate	±300°/s	0.25	±1% + drift of 360°/h	2°/s	
2	Pitch					
	a) Pitch attitude	±90°	0.25	±2°	0.5°	Pitch attitude is preferred, if not available, pitch rate shall be recorded
	b) Pitch rate	±300°/s	0.25	±1% + drift of 360°/h	2°/s	
3	Roll					
	a) Roll attitude	±180°	0.25	±2°	0.5°	Roll attitude is preferred, if not available, roll rate shall be recorded
	b) Roll rate	±300°/s	0.25	±1% + drift of 360°/h	2°/s	
4	Positioning system:					
	a) Time	24 hours	1	±0.5 s	0.1 s	UTC time preferred where available.
	b) Latitude/longitude	Latitude:±90° Longitude:±180°	2 (1 if available)	As installed (0.00015° recommended)	0.00005°	
	c) Altitude	-300 m (-1 000 ft) to maximum certificated altitude of aeroplane +1 500 m (5 000 ft)	2 (1 if available)	As installed (±15 m (±50 ft) recommended)	1.5 m (5 ft)	
	d) Ground speed	0-1 000 kt	2 (1 if available)	As installed (±5 kt recommended)	1 kt	
	e) Track	0-360°	2 (1 if available)	As installed (± 2° recommended)	0.5°	
	f) Estimated error	Available range	2 (1 if available)	As installed	As installed	Shall be recorded if readily available
5	Normal acceleration	-3 g to + 6 g (*)	0.25 (0.125 if available)	As installed (± 0.09 g excluding a datum error of ±0.45 g recommended)	0.004 g	
6	Longitudinal acceleration	±1 g (*)	0.25 (0.125 if available)	As installed (±0.015 g excluding a datum error of ±0.05 g recommended)	0.004 g	



No.	Parameter name	Minimum recording range	Maximum recording interval in seconds	Minimum recording accuracy	Minimum recording resolution	Remarks
7	Lateral acceleration	±1 g (*)	0.25 (0.125 if available)	As installed (±0.015 g excluding a datum error of ±0.05 g recommended)	0.004 g	
8	External static pressure (or pressure altitude)	34.4 mb (3.44 in-Hg) to 310.2 mb (31.02 in-Hg) or available sensor range	1	As installed (±1 mb (0.1 in-Hg) or ±30 m (±100 ft) to ±210 m (±700 ft) recommended)	0.1 mb (0.01 in-Hg) or 1.5 m (5 ft)	
9	Outside air temperature (or total air temperature)	-50° to +90°C or available sensor range	2	As installed (±2°C recommended)	1°C	
10	Indicated air speed	As the installed pilot display measuring system or available sensor range	1	As installed (±3 % recommended)	1 kt (0.5 kt recommended)	
11	Engine RPM	Full range including overspeed condition	Each engine each second	As installed	0.2% of full range	
12	Engine oil pressure	Full range	Each engine each second	As installed (5% of full range recommended)	2% of full range	
13	Engine oil temperature	Full range	Each engine each second	As installed (5% of full range recommended)	2% of full range	
14	Fuel flow or pressure	Full range	Each engine each second	As installed	2% of full range	
15	Manifold pressure	Full range	Each engine each second	As installed	0.2% of full range	
16	Engine thrust/power/torque parameters required to determine propulsive thrust/power*	Full range	Each engine each second	As installed	0.1% of full range	* Sufficient parameters e.g. EPR/N1 or torque/Np as appropriate to the particular engine shall be recorded to determine power in both normal and reverse thrust. A margin for possible overspeed should be provided.
17	Engine gas generator speed (Ng)	0-150%	Each engine each second	As installed	0.2% of full range	
18	Free power turbine speed (Nf)	0-150%	Each engine each second	As installed	0.2% of full range	
19	Coolant temperature	Full range	1	As installed (±5°C recommended)	1° C	
20	Main voltage	Full range	Each engine each second	As installed	1 Volt	
21	Cylinder head temperature	Full range	Each cylinder each second	As installed	2% of full range	
22	Flaps position	Full range or each discrete position	2	As installed	0.5°	



No.	Parameter name	Minimum recording range	Maximum recording interval in seconds	Minimum recording accuracy	Minimum recording resolution	Remarks
23	Primary flight control surface position	Full range	0.25	As installed	0.2 % of full range	
24	Fuel quantity	Full range	4	As installed	1% of full range	
25	Exhaust gas temperature	Full range	Each engine each second	As installed	2% of full range	
26	Emergency voltage	Full range	Each engine each second	As installed	1 Volt	
27	Trim surface position	Full range or each discrete position	1	As installed	0.3% of full range	
28	Landing gear position	Each discrete position*	Each gear every two seconds	As installed		* Where available, record up-and- locked and down-and-locked position
29	Novel/unique aircraft features	As required	As required	As required	As required	



Appendix 1 to OPS 1.770

Oxygen – Minimum Requirements for Supplemental Oxygen for Pressurised Aeroplanes

(a) SUPPLY FOR:	(b) DURATION AND CABIN PRESSURE ALTITUDE
1. All occupants of flight deck seats on flight deck duty	Entire flight time when the cabin pressure altitude exceeds 13000 ft and entire flight time when the cabin pressure altitude exceeds 10000 ft but does not exceed 13000 ft after the first 30 minutes at those altitudes, but in no case less than: (i) 30 minutes for aeroplanes certificated to fly at altitudes not exceeding 25000 ft (<i>Note 2</i>). (ii) 2 hours for aeroplanes certificated to fly at altitudes more than 25000 ft (<i>Note 3</i>).
2. All required cabin crew members	Entire flight time when cabin pressure altitude exceeds 13000 ft but not less than 30 minutes (<i>Note 2</i>), and entire flight time when cabin pressure altitude is greater than 10000 ft but does not exceed 13000 ft after the first 30 minutes at these altitudes.
3. 100% of passengers (<i>Note 5</i>)	Entire flight time when the cabin pressure altitude exceeds 15000 ft but in no case less than 10 minutes (<i>Note 4</i>).
4. 30% of passengers (<i>Note 5</i>)	Entire flight time when the cabin pressure altitude exceeds 14000 ft but does not exceed 15000 ft.
5. 10% of passengers (<i>Note 5</i>)	Entire flight time when the cabin pressure altitude exceeds 10000 ft but does not exceed 14000 ft after the first 30 minutes at these altitudes.

Note 1: The supply provided must take account of the cabin pressure altitude and descent profile for the routes concerned.

Note 2: The required minimum supply is that quantity of oxygen necessary for a constant rate of descent from the aeroplane's maximum certificated operating altitude to 10000 ft in 10 minutes and followed by 20 minutes at 10000 ft.

Note 3: The required minimum supply is that quantity of oxygen necessary for a constant rate of descent from the aeroplane's maximum certificated operating altitude to 10000 ft in 10 minutes and followed by 110 minutes at 10000 ft. The oxygen required in OPS 1.780(a)(1) may be included in determining the supply required.

Note 4: The required minimum supply is that quantity of oxygen necessary for a constant rate of descent from the aeroplane's maximum certificated operating altitude to 15000 ft in 10 minutes.

Note 5: For the purpose of this table 'passengers' means passengers actually carried and includes infants.



Appendix 1 to OPS 1.775
Supplemental Oxygen for Non-pressurised Aeroplanes

Table 1

(a)	(b)
SUPPLY FOR:	DURATION AND PRESSURE ALTITUDE
1. All occupants of flight deck seats on flight deck duty	Entire flight time at pressure altitudes above 10000 ft
2. All required cabin crew members	Entire flight time at pressure altitudes above 13000 ft and for any period exceeding 30 minutes at pressure altitudes above 10000 ft but not exceeding 13000 ft
3. 100% of passengers (See Note)	Entire flight time at pressure altitudes above 13000 ft.
4. 10% of passengers (See Note)	Entire flight time after 30 minutes at pressure altitudes greater than 10000 ft but not exceeding 13000 ft.

Note: For the purpose of this table 'passengers' means passengers actually carried and includes infants under the age of 2.

**SUBPART L****COMMUNICATION, NAVIGATION AND SURVEILLANCE EQUIPMENT****OPS 1.845 General Introduction**

(See AMC OPS 1.845)

- (a) The operator shall ensure that a flight does not commence unless the communication and navigation equipment required under this Subpart is:
- (1) approved and installed in accordance with the requirements applicable to them, including the minimum performance standard and the operational and airworthiness requirements;
 - (2) installed such that the failure of any single unit required for communication, navigation or surveillance purposes, or any combination thereof, will not result in the failure of another unit required for communication, navigation or surveillance purposes.
 - (3) in operable condition for the kind of operation being conducted except as provided in the MEL (OPS 1.030 refers); and
 - (4) so arranged that if equipment is to be used by one flight crew member at his station during flight it must be readily operable from his station. When a single item of equipment is required to be operated by more than one flight crew member it must be installed so that the equipment is readily operable from any station at which the equipment is required to be operated.
 - (5) The aeroplane shall be sufficiently provided with navigation equipment to ensure that, in the event of the failure of one item of equipment at any stage of the flight, the remaining equipment will enable the aeroplane to navigate in accordance with OPS 1.865(a) and OPS 1.865(d)(2) and OPS 1.872.
- (b) Communication and navigation equipment minimum performance standards are those prescribed in the applicable Technical Standard Orders (TSO) unless different performance standards are prescribed in the operational or airworthiness codes. Communication and navigation equipment which has already been approved does not need to comply with a revised TSO or a revised specification, other than TSO, unless a retroactive requirement is prescribed.

OPS 1.850 Communication Equipment

- (a) The operator shall not operate an aeroplane unless it is equipped with radio required for the kind of operation being conducted.
- (b) Where two independent (separate and complete) radio systems are required under this Subpart, each system must have an independent antenna installation except that, where rigidly supported non-wire antennae or other antenna installations of equivalent reliability are used, only one antenna is required.
- (c) The radio communication equipment required to comply with paragraph (a) above must also provide for communications on the aeronautical emergency frequency 121.5 MHz.
- (d) For operations where communication equipment is required to meet an RCP specification for performance-based communication (PBC), an aeroplane shall, in addition to the requirements specified in this Subpart:



- (1) be provided with communication equipment which will enable it to operate in accordance with the prescribed RCP specification(s); and
 - (2) have information relevant to the aeroplane RCP specification capabilities listed in the aeroplane flight manual or other aeroplane documentation approved by the State of Design or Authority, as the State of Registry, and
 - (3) have information relevant to the aeroplane RCP specification capabilities included in the MEL.
- (e) The Authority, for operations where an RCP specification for PBC has been prescribed, ensure that the operator has established and documented:
- (1) normal and abnormal procedures, including contingency procedures;
 - (2) flight crew qualification and proficiency requirements, in accordance with appropriate RCP specifications;
 - (3) a training programme for relevant personnel consistent with the intended operations; and
 - (4) appropriate maintenance procedures to ensure continued airworthiness, in accordance with appropriate RCP specifications.
- (f) The Authority shall ensure that, in respect of those aeroplanes mentioned in sub-paragraph (d) above, adequate provisions exist for:
- (1) receiving the reports of observed communication performance issued by monitoring programmes; and
 - (2) taking immediate corrective action for individual aircraft, aircraft types or operators, identified in such reports as not complying with the RCP specification.

OPS 1.855 Audio Selector Panel

The operator shall not operate an aeroplane under IFR unless it is equipped with an audio selector panel accessible to each required flight crew member.

OPS 1.860 Communication Equipment for Operations under VFR over Routes Navigated by Reference to Visual Landmarks

The operator shall not operate an aeroplane under VFR over routes that can be navigated by reference to visual landmarks, unless it is equipped with the radio communication equipment necessary under normal operating conditions to fulfil the following:

- (a) Communicate with appropriate ground stations;
- (b) Communicate with appropriate air traffic control facilities from any point in controlled airspace within which flights are intended; and
- (c) Receive meteorological information;



OPS 1.865 Communication and Navigation Equipment for Operations under IFR, or under VFR over Routes not Navigated by Reference to Visual Landmarks

(See AMC OPS 1.865)

- (a) The operator shall not operate an aeroplane under IFR, or under VFR over routes that cannot be navigated by reference to visual landmarks, unless the aeroplane is equipped with radio communication and SSR transponder and navigation equipment which will enable it to proceed:
- (1) in accordance with its operational flight plan; and
 - (2) in accordance with the requirements of air traffic services;
- (b) *Radio equipment.* the operator shall ensure that radio equipment comprises not less than;
- (1) two independent radio communication systems necessary under normal operating conditions to communicate with an appropriate ground station from any point on the route including diversions; and
 - (2) SSR transponder equipment as required for the route being flown.
- (c) For short-haul operations in the NAT HLA airspace not crossing the North Atlantic, an aeroplane may be equipped with one long range communication system (HF-system) only if alternative communication procedures are published for the airspace concerned.
- (d) *Navigation equipment.* the operator shall ensure that navigation equipment
- (1) Comprises not less than:
 - (i) one VOR receiving system, one ADF system, one DME except that an ADF system need not be installed provided that the use of ADF is not required in any phase of the planned flight (See AC OPS 1.865(d)(1)(i));
 - (ii) one ILS or MLS where ILS or MLS is required for approach navigation purposes;
 - (iii) one Marker Beacon receiving system where a Marker Beacon is required for approach navigation purposes;
 - (iv) an Area Navigation System when area navigation is required for the route being flown;
 - (v) an additional DME system on any route, or part thereof, where navigation is based only on DME signals;
 - (vi) an additional VOR receiving system on any route, or part thereof, where navigation is based only on VOR signals; and
 - (vii) an additional ADF system on any route, or part thereof, where navigation is based only on NDB signals, or
 - (2) For operations where a navigation specification for performance-based navigation (PBN) has been prescribed, an aeroplane shall, in addition to requirements specified in this Subpart;



- (i) be provided with navigation equipment which will enable it to operate in accordance with the prescribed navigation specification(s); and
 - (ii) have information relevant to the aeroplane navigation specification capabilities listed in the aeroplane flight manual or other aeroplane documentation approved by the State of Design or Authority, as the State of Registry, and
 - (iii) have information relevant to the aeroplane navigation specification capabilities included in the MEL. (See also AC OPS 1.243)
- (e) The operator may operate an aeroplane that is not equipped with an ADF or with the navigation equipment specified in sub-paragraph(s) (d)(1)(vi) and/or (d)(1)(vii) above, provided that it is equipped with alternative equipment authorised, for the route being flown, by the Authority. The reliability and the accuracy of alternative equipment must allow safe navigation for the intended route.
- (f) The operator shall ensure that VHF communication equipment, ILS Localizer and VOR receivers installed on aeroplanes to be operated in IFR are of a type that has been approved as complying with the FM immunity performance standards (See AC OPS 1.865(f)).
- (g) The operator shall ensure that aeroplanes conducting EDTO have a communication means capable of communicating with an appropriate ground station at normal and planned contingency altitudes. For EDTO routes where voice communication facilities are available, voice communications shall be provided. For all EDTO operations beyond 180 minutes, reliable communication technology, either voice based or data link, must be installed. Where voice communication facilities are not available and where voice communication is not possible or is of poor quality, communications using alternative systems must be ensured. (See AC OPS 1.865(g)).
- (h) On flights in which it is intended to land instrument meteorological conditions, an aeroplane shall be provided with radio equipment capable of receiving signals providing guidance to a point from which a visual landing can be effected. This equipment shall be capable of providing such guidance for each aerodrome at which it is intended to land in instrument meteorological conditions and for any designated alternate aerodromes.

OPS 1.866 Transponder equipment

- (a) The operator shall not operate an aeroplane unless it is equipped with;
- (1) A pressure altitude reporting SSR transponder which operates in accordance with the relevant provisions of ICAO Annex 10, Volume IV; and
 - (2) any other SSR transponder capability required for the route being flown.
- (b) All aeroplanes for which the individual certificate of airworthiness is first issued after 01 January 2009 shall be equipped with a data source that provides pressure-altitude information with a resolution of 7.62 m (25 ft), or better.
- (c) All aeroplanes shall be equipped with a data source that provides pressure-altitude information with a resolution of 7.62 m (25 ft), or better.
- Note: The Mode S transponder should be provided with the airborne/on-the-ground status if the aeroplane is equipped with an automatic means of detecting such status.*

**OPS 1.867 Surveillance Equipment**

- (a) An aeroplane shall be provided with surveillance equipment which will enable it to operate in accordance with the requirements of air traffic services.
- (b) For operations where surveillance equipment is required to meet an RSP specification for performance-based surveillance (PBS), an aeroplane shall, in addition to the requirements specified in sub-paragraph (a);
 - (1) be provided with surveillance equipment which will enable it to operate in accordance with the prescribed RSP specification(s);
 - (2) have information relevant to the aeroplane RSP specification capabilities listed in the flight manual or other aeroplane documentation approved by the State of Design or Authority; and
 - (3) have information relevant to the aeroplane RSP specification capabilities included in the MEL.
- (c) The Authority shall, for operations where an RSP specification for PBS has been prescribed, ensure that the operator has established and documented;
 - (1) normal and abnormal procedures, including contingency procedures;
 - (2) flight crew qualification and proficiency requirements, in accordance with appropriate RSP specifications;
 - (3) a training programme for relevant personnel consistent with the intended operations; and
 - (4) appropriate maintenance procedures to ensure continued airworthiness, in accordance with appropriate RSP specifications.
- (d) The Authority shall ensure that, in respect of those aeroplanes mentioned in sub-paragraph (b), adequate provisions exist for;
 - (1) receiving the reports of observed surveillance performance issued by monitoring programmes; and
 - (2) taking immediate corrective action for individual aircraft, aircraft types or operators, identified in such reports as not complying with the RSP specification.

OPS 1.870 Additional Navigation Equipment for Operations in NAT HLA Airspace

(See AC OPS 1.870)

- (a) The operator shall not operate an aeroplane in NAT HLA airspace unless it is equipped with navigation equipment that complies with minimum navigation performance specifications prescribed in ICAO Doc 7030 in the form of Regional Supplementary Procedures.
- (b) The navigation equipment required by this regulation shall;
 - (1) be visible and usable by either pilot seated at his/her duty station.
 - (2) continuously provides indications to the flight crew of adherence to or departure from track to the required degree of accuracy at any point along that track; and



- (3) be authorised by the State of the Operator for the operations concerned.
- (c) For unrestricted operation in NAT HLA airspace an aeroplane must be equipped with two independent Long Range Navigation Systems (LRNS).
- (d) For operation in NAT HLA airspace along notified special routes an aeroplane must be equipped with one Long Range Navigation System (LRNS), unless otherwise specified.

OPS 1.872 Equipment for Operation in Defined Airspace with Reduced Vertical Separation Minima (RVSM)

- (a) For flights in defined portions of airspace where RVSM of 1000 ft (300 m) is applied between FL 290 and FL 410 inclusive, the aeroplane shall be provided with equipment which is capable of;
 - (1) indicating to the flight crew the flight level being flown;
 - (2) automatically maintaining a selected flight level;
 - (3) providing an alert to the flight crew when a deviation occurs from the selected flight level. The threshold for the alert shall not exceed ± 90 m (300 ft); and
 - (4) automatically reporting pressure-altitude.

OPS 1.873 Electronic Navigation Data Management

- (a) The operator shall not use a navigation database which supports an airborne navigation application as a primary means of navigation unless the navigation database supplier holds a Type 2 Letter of Acceptance (LoA) or equivalent.
- (b) If the operator's supplier does not hold a Type 2 LoA or equivalent, the operator shall not use the electronic navigation data products unless the Authority has approved the operator's procedures for ensuring that the process applied and the delivered products have met equivalent standards of integrity.
- (c) The operator shall not use electronic navigation data products for other navigation applications unless the Authority has approved the operator's procedures for ensuring that the process applied and the delivered products have met standards of integrity acceptable for the intended use of the data.
- (d) The operator shall continue to monitor both the process and the products according to the requirements of OPS 1.035.
- (e) The operator shall implement procedures that ensure timely distribution and insertion of current and unaltered electronic navigation data to all aircraft that require it.

**SUBPART M****AEROPLANE MAINTENANCE****OPS 1.875 General**

(See AMC OPS 1.875)

- (a) Operators shall ensure that, in accordance with CAR GEN and this Subpart;
 - (1) each aeroplane they operate is maintained in an airworthy condition;
 - (2) the operational and emergency equipment necessary for an intended flight is serviceable; and
 - (3) the certificate of airworthiness of each aeroplane they operate remains valid.
- (b) Where reference is made to CAR 145 this includes those maintenance organisations accepted by the Authority in accordance with CAR GEN.010(a).
- (c) The operator shall not operate an aeroplane unless maintenance on the aeroplane, including any associated engine, propeller and part is carried out, and released to service by an organisation appropriately approved/accepted in accordance with CAR 145 except that pre-flight inspections need not necessarily be carried out by the CAR 145 organisation.
- (d) This Subpart prescribes aeroplane maintenance and continuing airworthiness requirements needed to comply with the operator certification requirements in OPS 1.180.

OPS 1.880 Terminology

The following definitions shall apply to this Subpart:

- (a) *Pre-flight inspection* – means the inspection carried out before flight to ensure that the aeroplane is fit for the intended flight. It does not include defect rectification.
- (b) *Approved standard* – means a manufacturing/design/maintenance/quality standard approved by the Authority.
- (c) *Approved by the Authority* – means approved by the Authority directly or in accordance with a procedure approved by the Authority.
- (d) *Continuing airworthiness* – means the set of processes by which an aircraft, engine, propeller or part complies with the applicable airworthiness requirements and remains in a condition for safe operation throughout its operating life.
- (e) *Continuing airworthiness records* – means records which are related to the continuing airworthiness status of an aircraft, engine, propeller or associated part.

OPS 1.885 Application for and Approval of the Operator's Maintenance System

- (a) For the approval of the maintenance system, an applicant for the initial issue and variation of an AOC shall submit the documents specified in OPS 1.185(b). (See AMC OPS 1.885(a).)



- (b) An applicant for the initial issue and variation of an AOC shall meet the requirements of this Subpart, in conjunction with an appropriate maintenance management exposition, as a minimum for the maintenance system to be approved by the Authority. (See AMC OPS 1.885(b))

OPS 1.890 Maintenance Responsibility

(See Appendix 1 to OPS 1.890)

- (a) The operator shall ensure the airworthiness of the aeroplane and the serviceability of both operational and emergency equipment by (See AMC OPS 1.890(a)):
- (1) The accomplishment of pre-flight inspections (See AMC OPS 1.890(a)(1));
 - (2) The rectification to an approved standard of any defect and damage affecting safe operation, taking into account the minimum equipment list and configuration deviation list if available for the aeroplane type (See AMC OPS 1.890(a)(2));
 - (3) The accomplishment of all maintenance in accordance with the approved operator's aeroplane maintenance programme specified in OPS 1.910 (See AMC OPS 1.890(a)(3));
 - (4) The analysis of the effectiveness of the operator's approved aeroplane maintenance programme (See AMC OPS 1.890(a)(4));
 - (5) The accomplishment of any operational directive, airworthiness directive and any other continued airworthiness requirement made mandatory by the Authority. (See AMC OPS 1.890(a)(5));
 - (6) The accomplishment of modifications in accordance with CAR 21 Subpart C and, for non-mandatory modifications, the establishment of an embodiment policy. (See AMC OPS 1.890(a)(6).)
 - (7) Ensuring only materials, parts, components and appliances that conform with CAR 21, Subpart K are installed on the aircraft; and
 - (8) Ensuring maintenance records produced by the contracted maintenance organisations are in the English language.
- (b) The operator shall ensure that the Certificate of Airworthiness for each aeroplane operated remains valid in respect of:
- (1) The requirements in sub-paragraph (a) above;
 - (2) Any calendar expiry date specified in the certificate; and
 - (3) Any other maintenance condition specified in the certificate.
 - (4) The requirements specified in subparagraph (a) above must be performed in accordance with procedures acceptable to the Authority.
 - (5) Where applicable, conducting an Airworthiness Review in accordance with an approved procedure in the MME in support of a Certificate of Airworthiness that has a 24 month periodicity (see Appendix 1 to OPS 1.890).



- (c) Except as provided for in paragraph OPS 1.890(d), the airworthiness directives applicable under these regulations are those airworthiness directives or equivalent mandatory continued airworthiness requirements:
- (1) prescribed for that aircraft or product by the State of type certification to which the Type Acceptance Certification refers; and
 - (2) any prescribed by the state of certification of an applicable approved design change.
- (d) Compliance with alternative or additional airworthiness directives may be required as a condition of issue or continuity of the Type Acceptance Certificate.

OPS 1.895 Maintenance Management

- (a) The operator must be appropriately approved in accordance with CAR 145 to perform the maintenance as specified in OPS 1.890(a)(2), (3), (5) and (6) except when the Authority is satisfied that the maintenance can be contracted to an appropriate CAR 145 approved organisation or an organisation accepted in accordance with CAR GEN.010(a). Aeroplane base and scheduled line maintenance and engine maintenance contracts, together with all amendments, must be acceptable to the Authority. The Authority does not require the commercial elements of a maintenance contract. (See AMC OPS 1.895(a))
- (b) The operator must employ a person or group of persons acceptable to the Authority to ensure that all maintenance and continuing airworthiness functions are carried out on time to an approved standard such that the maintenance responsibility requirements prescribed in OPS 1.890 are satisfied. The person, or senior person as appropriate, is the nominated postholder referred to in OPS 1.175(i)(2). The nominated postholder for continuing airworthiness is also responsible for any corrective action resulting from the quality monitoring of OPS 1.900(a). (See AMC OPS 1.895(b))
- (c) The nominated postholder for continuing airworthiness should not be employed by a CAR 145 approved/accepted Organisation under contract to the operator, unless specifically agreed by the Authority. (See AMC OPS 1.895(c)).
- (d) When the operator does not employ sufficient qualified, competent people to carry out the continuing airworthiness requirements specified in OPS 1.890(a)(2), (3), (5) and (6), arrangements must be made with an organisation acceptable to the Authority to carry out these requirements. Except as otherwise specified in paragraphs (e), (f) and (g) below, the arrangement must be in the form of a written contract between the operator and the organisation accepted by the Authority detailing the functions specified in OPS 1.890(a)(2), (3), (5) and (6) and defining the support of the quality functions of OPS 1.900. (See AMC OPS 1.895(d))
- (e) Notwithstanding paragraph (d) above, the operator may have a contract with an organisation, provided that;
- (1) for aeroplane or engine continuing airworthiness contracts, the contracted organisation is a CAR OPS 1 operator of the same type of aeroplane, or an organisation acceptable to the Authority,
 - (2) all maintenance is ultimately performed by a CAR 145 approved organisation or an organisation accepted in accordance with CAR GEN.010(a);
 - (3) such a contract details the functions specified in OPS 1.890(a)(2), (3), (5) and (6) and defines the support of the quality functions of OPS 1.900,



- (4) the contract, together with all amendments, is acceptable to the Authority. The Authority does not require the commercial elements of a maintenance contract. (See AMC OPS 1.895(e))
- (f) Notwithstanding paragraph (a) above, in the case of an aeroplane needing occasional line maintenance, the contract may be in the form of individual work orders to the Maintenance Organisation. (See AMC OPS 1.895(f & g))
- (g) Notwithstanding paragraph (a) above, in the case of aeroplane component maintenance, including engine maintenance, the contract may be in the form of individual work orders to the Maintenance Organisation. (See AMC OPS 1.895(f & g))
- (h) The operator must provide suitable office accommodation at appropriate locations for the personnel specified in sub-paragraph (b) above. (See AMC OPS 1.895(h))
- (i) The operator shall ensure that all personnel assigned to, or directly involved in, continuing airworthiness and Quality Assurance functions are properly trained, have demonstrated their abilities in their particular duties and are aware of their responsibilities and the relationship of such duties to the operation as a whole in accordance with a procedure acceptable to the Authority.

OPS 1.900 Quality System

(See AMC OPS 1.900)

(See AMC OPS 1.900)

- (a) For maintenance purposes, the operator's Quality System, as required by OPS 1.035, must additionally include at least the following functions:
 - (1) Monitoring that the activities of OPS 1.890 are being performed in accordance with the accepted procedures;
 - (2) Monitoring that all contracted maintenance and continuing airworthiness tasks are carried out in accordance with the contract; and
 - (3) Monitoring the continued compliance with the requirements of this Subpart.
- (b) Where the operator is approved in accordance with CAR 145, the Quality System may be combined with that required by CAR 145.

OPS 1.905 Operator's Maintenance Management Exposition

(See Appendix 1 to AMC OPS 1.905(a))

- (a) The operator shall provide, for the use and guidance of maintenance and operational personnel concerned, a Maintenance Management Exposition, the design of which shall observe Human Factors principles.
- (b) The operator shall ensure that the Maintenance Management Exposition;
 - (1) is amended as necessary to keep the information contained therein up to date;
 - (2) amendments are furnished promptly to all organisations or persons to whom the manual has been issued; and



- (3) is provided to the Authority, together with all amendments and/or revisions to it and the operator shall incorporate in it such mandatory material as the Authority may require.
- (c) The Maintenance Management Exposition shall contain the following information; (See AMC OPS 1.905(a))
- (1) procedures that ensure each aeroplane operated is maintained in a airworthy condition;
 - (2) procedures that ensure that the operational and emergency equipment for an intended flight is serviceable;
 - (3) procedures that ensure that the certificate of airworthiness of each aeroplane operated remains valid;
 - (4) a description of the administrative arrangements between the operator and the approved maintenance organisation;
 - (5) if applicable, a description of the maintenance procedures and the procedure for completing and signing a certificate of release to service when maintenance is based on a system other than that of an approved maintenance organisation;
 - (6) details of the organisational structure (See AMC OPS 1.905(a)) including the names and duties of the nominated postholder responsible for continuing airworthiness required by OPS 1.175(i)(2) and the person, or group of persons, referred to in OPS 1.895(b);
 - (7) procedures that must be followed to satisfy the maintenance responsibility of OPS 1.890 and the quality functions of OPS 1.900, except that where the operator is appropriately approved as a maintenance organisation in accordance with CAR 145, such details may be included in the CAR 145 exposition;
 - (8) reference to the maintenance programmes approved by the Authority, as the State of Registry;
 - (9) procedure for monitoring and assessing maintenance and operational experience with respect to continuing airworthiness and mandatory reporting of occurrences;
 - (10) procedures for obtaining and assessing continuing airworthiness information and recommendations available from the organisation responsible for the type design and implementing resulting actions considered necessary;
 - (11) procedures that ensure that all modifications and repairs comply with CAR 21 and ensuring that the substantiating data supporting compliance with the requirements are retained;
 - (12) procedures for occurrence reporting to comply with OPS 1.420 and CAR GEN.183 and the procedure for advising the Authority, as the State of Registry;
 - (13) procedures for implementing action resulting from mandatory continuing airworthiness information;
 - (14) a description of establishing and maintaining a system of analysis and continued monitoring of the performance and efficiency of the maintenance programme, in order to correct any deficiency in that program;



- (15) a description of the aircraft types, models, registration and serial number to which the Maintenance Management Manual applies;
- (16) a description of the procedures for ensuring that unserviceabilities affecting airworthiness are recorded and rectified; and
- (17) A description of the methods used for the completion and retention of the operator's continuing airworthiness required by OPS 1.920.

OPS 1.910 Operator's Aeroplane Maintenance Programme

- (a) The operator must ensure that the aeroplane is maintained in accordance with the approved aeroplane maintenance programme. The maintenance programme must contain details, including frequency, of all maintenance required to be carried out. The maintenance programme will be required to include a reliability programme when the Authority determines that such a reliability programme is necessary. (See AMC OPS 1.910(a))
- (b) The operator shall provide, for the use and guidance of maintenance and operational personnel concerned, a maintenance programme, approved by the Authority, containing the following information:
 - (1) maintenance tasks and the intervals at which these are to be performed, taking into account the anticipated utilization of the aeroplane;
 - (2) when applicable, a continuing structural integrity programme;
 - (3) procedures for changing or deviating from (1) and (2) above; and
 - (4) when applicable, condition monitoring and reliability programme descriptions for aircraft systems, components and engines.
- (c) Maintenance tasks and intervals that have been specified as mandatory in approval of the type design shall be identified as such.
- (d) The design and application of the operator's maintenance programme shall observe Human Factors principles.
- (e) Copies of all amendments to the maintenance programme shall be furnished promptly to all organisations or persons to whom the maintenance programme has been issued.
- (f) The operator's approved aeroplane maintenance programme must be subject to periodic reviews and amended when necessary. The reviews will ensure that the maintenance programme continues to be valid in light of operating experience whilst taking into account new and/or modified maintenance instructions promulgated by the Type Certificate holder. (See AMC OPS 1.910(f))
- (g) The operator's approved aeroplane maintenance programme must reflect applicable mandatory regulatory requirements addressed in documents issued by the Authority and Type Certificate holder to comply with aircraft certification requirements. (See AMC OPS 1.910(g)).
- (h) The operator's aeroplane maintenance programme and any subsequent amendment must be approved by the Authority, as the State of Registry. (See AMC OPS 1.910(h))



- (i) The periods prescribed by the Authority’s approved maintenance programme may be varied by the operator provided that such variations are within the limits specified in OPS 1.910 (j). Variations are only permitted when the periods prescribed by the maintenance programme, or documents in support of the maintenance programme, cannot be complied with due to circumstances which could not reasonably have been foreseen by the operator. Particulars of every variation so made shall be entered in the appropriate aircraft records.
- (j) The permitted variations to the maintenance programme in accordance with OPS 1.910(i) are;
 - (1) Items Controlled by Flying Hours:
 - 5000 flying hours or less; 10%
 - More than 5000 flying hours; 500 flying hours
 - (2) Items Controlled by Calendar Time:
 - 1 year or less: 10% or 1 month, whichever is the lesser
 - More than 1 year but not exceeding 3 years: 2 months
 - More than 3 years: 3 months
 - (3) Items Controlled by Landing/Cycles:
 - 500 landings/cycles or less: 10% or 25 landings/cycles, whichever is the lesser
 - More than 500 landings/cycles: 10% or 500 landings/cycles, whichever is the lesser

OPS 1.915 Aeroplane Technical Log
 (See AMC OPS 1.915)

- (a) The operator must use an aeroplane technical log system containing the following information for each aeroplane:
 - (1) the name of the operator;
 - (2) the registration and designation of the aircraft;
 - (3) record of aircraft utilisation including total time (daily, hours, cycles sectors) as applicable including those cycles, such as landings, pressure cycles, engine power ranges, which affect the life of an aircraft or component;
 - (4) records of ground de-icing/anti-icing, including duration and type of fluid applied;
 - (5) records of fuel and oil;
 - (6) the maintenance status of the aircraft, the identity of the next scheduled inspection, including date/hours/cycles at which any other out of phase maintenance/inspection is required;



- (7) any defects or abnormal occurrences found by the pilot during or following a flight; and details of rectification of defects occurring between scheduled inspections including the certificate of release to service for any rectification;
 - (8) details of any deferred rectification including any inoperative equipment with which the aircraft is permitted to be flown under the applicable CARs relating to the operation of the aircraft;
 - (9) records for special operations such as AWOPs and EDTOs;
 - (10) the information required by the applicable CARs relating to the operation of the aircraft;
 - (11) any necessary maintenance support information for the pilot; and
 - (12) the pre-flight inspection signature.
- (b) The content of the technical log may be altered from that in this regulation if alternative methods of recording this data acceptable to the Authority are used.
- (c) The technical log shall be kept in hard copy form or in electronic coded form provided that this form allows for the preservation and retrieval of information.
- (d) The aeroplane technical log system and any subsequent amendment must be approved by the Authority.

OPS 1.920 Continuing Airworthiness Records

(See AMC OPS 1.920)

- (a) The operator shall ensure that the aeroplane technical log is retained for 24 months after the date of the last entry.
- (b) The operator shall ensure that a system has been established to keep, in a form and format that ensures readability, security and integrity of the records at all times and is acceptable to the Authority.

Note: The form and format of the records may include, for example, paper records, film records, electronic records or any combination thereof.

- (c) The continuing airworthiness records shall be retained for the periods specified in CAR GEN.058.
- (d) In the event of a temporary change of operator, the records shall be made available to the new operator. In the event of any permanent change of operator, the records shall be transferred to the new operator. (See AMC OPS 1.920(c)).

OPS 1.930 Continued Validity of the Air Operator Certificate in Respect of the Maintenance System

(See AMC OPS 1.930)

The operator must comply with OPS 1.175 and OPS 1.180 to ensure continued validity of the air operator certificate in respect of the maintenance system.

**OPS 1.935 Equivalent Safety Case**

(See AMC OPS 1.935)

The operator shall not introduce alternative procedures to those prescribed in this Subpart unless needed and an equivalent safety case has first been approved by the Authority.

OPS 1.937 Continuing Airworthiness

- (a) The operator of an aeroplane over 5700 kg maximum certificated take-off mass shall monitor and assess maintenance and operational experience with respect to continuing airworthiness and provide the information as prescribed by the Authority and report through the system specified in CAR GEN.205(f) and (g).
- (b) The operator of an aeroplane over 5700 kg maximum certificated take-off mass shall obtain and assess continuing airworthiness information and recommendations available from the organisation responsible for the type design and shall implement resulting actions considered necessary in accordance with a procedure acceptable to the Authority.

**Appendix 1 to OPS 1.890****Airworthiness Review in Support of a C of A with a 24 Month Validity**

- (a) The certificate of airworthiness of an aircraft operating in accordance with CAR OPS 1 shall have a 12 month period of validity. The validity may be extended to 24 months by the Authority provided the operator receives an “Operators Maintenance System Approval” for Airworthiness Reviews.
- (b) Aircraft that may have their certificate of airworthiness validity extended to a 24 month period of validity shall meet the following criteria;
- (1) The Airworthiness Review shall be conducted prior to the expiry of 12 months from the date of issue of the certificate of airworthiness.
 - (2) The Airworthiness Review may be conducted within 60 days before expiry of 12 months without affecting the renewal date of the C of A.
 - (3) The Airworthiness Review shall be documented in a format acceptable to the Authority and a copy shall be carried on board the aircraft with the current C of A.
 - (4) A copy of the Airworthiness Review documentation shall be submitted to the Authority within 10 days of completion.
 - (5) The Airworthiness Review shall include the confirmation of continuing compliance with the following items as a minimum;
 - (i) airworthiness Directives up to the latest published issue;
 - (ii) Authority accepted Type Certificate Data Sheet;
 - (iii) Maintenance Programme at the latest issue approved by the Authority;
 - (iv) component service life limits;
 - (v) airworthiness limitations;
 - (vi) that the aircraft has been weighed in the previous five years and there is a valid weight and centre of gravity schedule reflecting the current configuration of the aircraft;
 - (vii) all embodied modifications and repairs have been accepted or approved by the Authority;
 - (viii) all defects have been corrected or deferred in accordance with the MEL;
 - (ix) the current Flight Manual including applicable supplements are complete and up to date and reflect the current configuration of the aircraft;
 - (x) applicable operational requirements as applicable to this aircraft;
 - (xi) navigational software latest updates; and



- (xii) control of further, or repeat tasks, associated with non-permanent repairs to the aircraft, engines or components
- (6) The operator shall record what supporting data was reviewed to confirm compliance with the items in paragraph (b)(6) above. This record shall be placed in the continuing airworthiness records for the aircraft together with a copy of the completed and signed documentation.
- (c) The operator shall produce additional procedures to be included in the Maintenance Management Exposition (MME). (See Appendix 1 to AMC OPS 1.905(a)).
- (d) The MME shall;
 - (1) be submitted for Authority acceptance; and
 - (2) clearly describe the nominated postholder(s)' authorisation and responsibilities for conducting an Airworthiness Review.
- (e) The nominated postholder shall demonstrate the necessary competencies to undertake an Airworthiness Review.



This Page Intentionally Left Blank

**SUBPART N****FLIGHT CREW****OPS 1.940 Composition of Flight Crew**

(See Appendices 1 & 2 to OPS 1.940)

- (a) The operator shall ensure that;
- (1) the number and composition of the flight crew shall not be less than that specified in the operations manual.
 - (2) the flight crews shall include flight crew members in addition to the minimum numbers specified in the Aeroplane Flight Manual or other documents associated with the certificate of airworthiness, when necessitated by considerations related to the type of aeroplane used, the type of operation involved and the duration of flight between points where flight crews are changed.
 - (3) all flight crew members hold an applicable and valid licence acceptable to the Authority and are suitably qualified and competent to conduct the duties assigned to them;
 - (4) the flight crew shall include at least one member who holds a valid licence, issued or rendered valid by the Authority, authorising operation of the type of radio transmitting equipment to be used;
 - (5) procedures are established, acceptable to the Authority, to prevent the crewing together of inexperienced flight crew members (See AMC OPS 1.940(a)(4));
 - (6) one pilot amongst the flight crew, qualified as a pilot-in-command in accordance with the requirements governing flight crew licences, is designated as the pilot-in-command who may delegate the conduct of the flight to another suitably qualified pilot; and
 - (7) when a dedicated System Panel Operator is required by the AFM, the flight crew includes one crew member who holds a Flight Engineer's licence or is a suitably qualified flight crew member and acceptable to the Authority.
 - (8) when engaging the services of flight crew members who are self-employed and/or working on a freelance or part-time basis, the requirements of Subpart N are complied with. In this respect, particular attention must be paid to the total number of aircraft types or variants that a flight crew member may fly for the purposes of commercial air transportation, which must not exceed the requirements prescribed in OPS 1.980 and OPS 1.981, including when his/her services are engaged by another operator. For crew members serving the operator as a pilot-in-command, initial operator's Crew Resource Management (CRM) training shall be completed before commencing unsupervised line flying unless the crew member has previously completed an initial operator's CRM course.
- (b) Minimum flight crew for operations under IFR or at night. For operations under IFR or at night, the operator shall ensure that;
- (1) for all turbo-propeller aeroplanes with a maximum approved passenger seating configuration of more than 9 and for all turbojet aeroplanes, the minimum flight crew is 2 pilots; or



- (2) aeroplanes other than those covered by sub-paragraph (b)(1) above are operated by a single-pilot provided that the requirements of Appendix 2 to OPS 1.940 are satisfied. If the requirements of Appendix 2 are not satisfied, the minimum flight crew is 2 pilots.

OPS 1.941 Flight Crew Member Training Programmes

- (a) The operator shall establish and maintain a ground and flight training programme, approved by the Authority, which ensures that all flight crew members are adequately trained to perform their assigned duties. The training programme shall:
 - (1) include ground and flight training facilities and properly qualified instructors as determined by the Authority;
 - (2) consist of ground and flight training in the type(s) of aeroplane on which the flight crew member serves;
 - (3) include proper flight crew coordination and training in all types of emergency and abnormal situations or procedures caused by engine, airframe or systems malfunctions, fire or other abnormalities;
 - (4) include upset prevention and recovery training;
 - (5) include training in knowledge and skills related to visual and instrument flight procedures for the intended area of operation, charting, human performance including threat and error management and in the transport of dangerous goods;
 - (6) ensure that all flight crew members know the functions for which they are responsible and the relation of these functions to the functions of other crew members, particularly in regard to abnormal or emergency procedures; and
 - (7) be given on a recurrent basis, as determined by the Authority and shall include an assessment of competence.

OPS 1.943 Initial Operator's Crew Resource Management (CRM) Training

(See AC OPS (AMC) 1.943/1.945(a)(9)/1.955(b)(6)/1.965(e))

(See AC OPS (AMC) 1.943/1.945(a)(9)/1.955(b)(6)/1.965(e))

- (a) When a flight crew member has not previously completed initial operator's Crew Resource Management (CRM) training (either new employees or existing staff), then the operator shall ensure that the flight crew member completes an initial CRM training course. New employees shall complete initial operator's CRM Training within their first year of joining The operator.
- (b) If the flight crew member has not previously been trained in Human Factors then a theoretical course, based on the human performance and limitations programme for the ATPL (see the requirements applicable to the issue of Flight Crew Licences) shall be completed before the initial operator's CRM training or combined with the initial Operator's CRM training.
- (c) Initial CRM training shall be conducted by at least one CRM trainer acceptable to the Authority who may be assisted by experts in order to address specific areas. (See AC OPS (AMC) 1.943/1.945(a)(9)/1.955(b)(6)/1.965(e)).
- (d) Initial CRM training is conducted in accordance with a detailed course syllabus included in the Operations Manual.

**OPS 1.945 Conversion Training and Checking**

(See Appendix 1 to OPS 1.945)

(See AMC OPS 1.945)

(See AMC OPS 1.945)

(See AC OPS (AMC) 1.943/ 1.945(a)(9)/1.955(b)(6)/ 1.965(e))

(See AC OPS (AMC) 1.943/ 1.945(a)(9)/1.955(b)(6)/ 1.965(e))

- (a) The operator shall ensure that;
- (1) a flight crew member completes a type rating course which satisfies the requirements applicable to the issue of flight crew licences when changing from one type of aeroplane to another type or class for which a new type or class rating is required;
 - (2) a flight crew member completes the operator's conversion course before commencing unsupervised line flying:
 - (i) when changing to an aeroplane for which a new type or class rating is required; or
 - (ii) when changing operator;
 - (3) conversion training is conducted by suitably qualified personnel in accordance with a detailed course syllabus included in the Operations Manual. The operator shall ensure that the personnel integrating elements of CRM into conversion training are suitably qualified;
 - (4) the amount of training required by the operator's conversion course is determined after due note has been taken of the flight crew member's previous training as recorded in his training records prescribed in OPS 1.985;
 - (5) the minimum standards of qualification and experience required of flight crew members before undertaking conversion training are specified in the Operations Manual;
 - (6) each flight crew member undergoes the checks required by OPS 1.965(b) and the training and checks required by OPS 1.965(d) before commencing line flying under supervision;
 - (7) upon completion of line flying under supervision, the check required by OPS 1.965(c) is undertaken;
 - (8) once the operator's conversion course has been commenced, a flight crew member does not undertake flying duties on another type or class until the course is completed or terminated; and
 - (9) elements of CRM training are integrated into the conversion course.
- (See AC OPS (AMC) 1.943/1.945(a)(9)/1.955(b)(6)/1.965(e) & AC OPS (AMC) 1.943/1.945(a)(9)/1.955(b)(6)/1.965(e) and AMC OPS 1.945(a)(9)).
- (b) In the case of changing aeroplane type or class, the check required by 1.965(b) may be combined with the type or class rating skill test under the requirements applicable to the issue of flight crew licences.
- (c) The operator's conversion course and the Type or Class Rating course required for the issue of flight crew licences may be combined.



- (d) A pilot, undertaking a zero flight time training (ZFTT) course, shall:
- (1) commence Line Flying Under Supervision as soon as possible within 21 days after completion of the skill test. If Line Flying Under Supervision has not been commenced within the 21 days, the operator shall provide appropriate training acceptable to the Authority.
 - (2) complete the six take-offs and landings in a flight simulator, suitably qualified and user approved by the Authority, not later than 21 days after the completion of the skill test. This simulator session shall be conducted by a TRI(A) occupying a pilot's seat. When approved by the Authority, the number of take-offs and landings may be reduced. If these take-offs and landings have not been performed within the 21 days, the operator shall provide refresher training acceptable to the Authority.
 - (3) conduct the first four take-offs and landings of the Line Flying Under Supervision in the aeroplane under the supervision of a TRI(A) occupying a pilot's seat. When approved by the Authority, the number of take-offs and landings may be reduced.

OPS 1.950 Differences Training and Familiarisation Training

- (a) The operator shall ensure that a flight crew member completes;
- (1) differences training which requires additional knowledge and training on an appropriate training device or the aeroplane;
 - (i) when operating another variant of an aeroplane of the same type or another type of the same class currently operated; or
 - (ii) when changing equipment and/or procedures on types or variants currently operated;
 - (2) familiarisation training which requires the acquisition of additional knowledge:
 - (i) when operating another aeroplane of the same type or variant; or
 - (ii) when changing equipment and/or procedures on types or variants currently operated.
- (b) The operator shall specify in the Operations Manual when such differences training or familiarisation training is required.

OPS 1.955 Nomination as Commander

- (a) The operator shall ensure that for upgrade to commander from co-pilot and for those joining as commanders:
- (1) A minimum level of experience, acceptable to the Authority, is specified in the Operations Manual; and
 - (2) For multi-crew operations, the pilot completes an appropriate command course.
- (b) The command course required by sub-paragraph (a)(2) above must be specified in the Operations Manual and include at least the following:



- (1) Training in an FSTD (including Line Orientated Flying Training) and/or flying training;
- (2) The operator proficiency check operating as commander;
- (3) Commander's responsibilities;
- (4) Line training in command under supervision. A minimum of 10 sectors is required for pilots already qualified on the aeroplane type;
- (5) Completion of a commander's line check as prescribed in OPS 1.965(c) and route and aerodrome competence qualification as prescribed in OPS 1.975; and
- (6) Elements of Crew Resource Management.

(See AC OPS (AMC) 1.943/1.945(a)(9)/1.955(b)(6)/1.965(e) & AC OPS (AMC) 1.943/1.945(a)(9)/1.955(b)(6)/1.965(e).)

OPS 1.960 Commanders Holding a Commercial Pilot Licence

- (a) The operator shall ensure that:
 - (1) A Commercial Pilot Licence (CPL) holder does not operate as a commander of an aeroplane certificated in the Aeroplane Flight Manual for single-pilot operations unless:
 - (i) when conducting passenger carrying operations under Visual Flight Rules (VFR) outside a radius of 50 NM from an aerodrome of departure, the pilot has a minimum of 500 hours total flight time on aeroplanes or holds a valid Instrument Rating; or
 - (ii) when operating on a multi-engine type under Instrument Flight Rules (IFR), the pilot has a minimum of 700 hours total flight time on aeroplanes which includes 400 hours as pilot-in-command in accordance with the requirements governing Flight Crew Licenses, of which 100 hours have been under IFR including 40 hours multi-engine operation. The 400 hours as pilot-in-command may be substituted by hours operating as co-pilot on the basis of two hours co-pilot is equivalent to one hour as pilot-in-command provided those hours were gained within an established multi-pilot crew system prescribed in the Operations Manual;
 - (2) In addition to sub-paragraph (a)(1)(ii) above, when operating under IFR as a single-pilot, the requirements prescribed in Appendix 2 to OPS 1.940 are satisfied; and
 - (3) In multi-pilot crew operations, in addition to sub-paragraph (a)(1) above, and prior to the pilot operating as commander, the command course prescribed in OPS 1.955(a)(2) is completed.

OPS 1.965 Recurrent Training and Checking

(See Appendices 1 & 2 to OPS 1.965)

(See AMC OPS 1.965)

(See AC OPS (AMC) 1.943/1.945(a)(9)/1.955(b)(6)/1.965(e))

(See AC OPS (AMC) 1.943/1.945(a)(9)/1.955(b)(6)/1.965(e))

(See AMC OPS 1.965)

- (a) *General.* the operator shall ensure that;



- (1) each flight crew member undergoes recurrent training and checking and that all such training and checking is relevant to the type or variant of aeroplane on which the flight crew member operates;
 - (2) a recurrent training and checking programme is established in the Operations Manual and approved by the Authority;
 - (3) recurrent training is conducted by the following personnel:
 - (i) *Ground and refresher training* – by suitably qualified personnel;
 - (ii) *Aeroplane/FSTD training* - by a Type Rating Instructor (TRI), Class Rating Instructor (CRI) or in the case of the FSTD content, a Synthetic Flight Instructor (SFI), providing that the TRI, CRI or SFI satisfies the operator's experience and knowledge requirements sufficient to instruct on the items specified in paragraphs (a)(1)(i)(A) and (B) of Appendix 1 to OPS 1.965;
 - (iii) *Emergency and safety equipment training* – by suitably qualified personnel; and
 - (iv) *Crew Resource Management (CRM)*:
 - (A) Integration of CRM elements into all their phases of the recurrent training - by all the personnel conducting recurrent training. the operator shall ensure that all personnel conducting recurrent training are suitably qualified to integrate elements of CRM into this training;
 - (B) Modular CRM training – by at least one CRM trainer acceptable to the Authority (see AMC OPS 1.943/1.945(a)(9)/1.955(b)(6)/1.965(e)) who may be assisted by experts in order to address specific areas.
 - (4) Recurrent checking is conducted by the following personnel:
 - (i) *Operator proficiency check* – by a Type Rating Examiner (TRE), Class Rating Examiner (CRE) or, if the check is conducted in a FSTD, a TRE, CRE or a Synthetic Flight Examiner (SFE), trained in CRM concepts and the assessment of CRM skills;
 - (ii) *Line checks* – by suitably qualified commanders nominated by the operator and acceptable to the Authority;
 - (iii) *Emergency and safety equipment checking* – by suitably qualified personnel.
- (b) *Operator Proficiency Check*
- (1) The operator shall ensure that;
 - (i) each flight crew member undergoes operator proficiency checks to demonstrate his competence in carrying out normal, abnormal and emergency procedures;
 - (ii) the check is conducted without external visual reference when the flight crew member will be required to operate under IFR; and



- (iii) each flight crew member undergoes operator proficiency checks as part of a normal flight crew complement.
- (2) The period of validity of the operator proficiency check shall be 6 calendar months in addition to the remainder of the month of issue. If issued within the final 3 calendar months of validity of a previous operator proficiency check, the period of validity shall extend from the date of issue until 6 calendar months from the expiry date of that previous operator proficiency check.
- (c) *Line Check.* the operator shall ensure that each flight crew member undergoes a line check on the aeroplane to demonstrate his/her competence in carrying out normal line operations described in the Operations Manual. The period of validity of a line check shall be 12 calendar months, in addition to the remainder of the month of issue. If issued within the final 3 calendar months of validity of a previous line check the period of validity shall extend from the date of issue until 12 calendar months from the expiry date of that previous line check. (See AMC OPS 1.965(c)).
- (d) *Emergency and Safety Equipment training and checking.* the operator shall ensure that each flight crew member undergoes training and checking on the location and use of all emergency and safety equipment carried. The period of validity of an emergency and safety equipment check shall be 12 calendar months in addition to the remainder of the month of issue. If issued within the final 3 calendar months of validity of a previous emergency and safety check, the period of validity shall extend from the date of issue until 12 calendar months from the expiry date of that previous emergency and safety equipment check. (See AMC OPS 1.965(d)).
- (e) *CRM.* the operator shall ensure that;
 - (1) elements of CRM are integrated into all appropriate phases of the recurrent training, and;
 - (2) each flight crew member undergoes specific modular CRM training. All major topics of CRM training shall be covered over a period not exceeding 3 years;
- (f) *Ground and Refresher training.* the operator shall ensure that each flight crew member undergoes ground and refresher training at least every 12 calendar months. If the training is conducted within 3 calendar months prior to the expiry of the 12 calendar months period, the next ground and refresher training must be completed within 12 calendar months of the original expiry date of the previous ground and refresher training.
- (g) *Aeroplane/FSTD training.* the operator shall ensure that each flight crew member undergoes aeroplane/FSTD training at least every 12 calendar months. If the training is conducted within 3 calendar months prior to the expiry of the 12 calendar months period, the next aeroplane/FSTD training must be completed within 12 calendar months of the original expiry date of the previous aeroplane/FSTD training.

OPS 1.968 Pilot Qualification to Operate in Either Pilot's Seat

(See Appendix 1 to OPS 1.968)

- (a) The operator shall ensure that;
 - (1) a pilot who may be assigned to operate in either pilot's seat completes appropriate training and checking; and



- (2) the training and checking programme is specified in the Operations Manual and is acceptable to the Authority.

OPS 1.970 Recent Experience

- (a) The operator shall ensure that;
 - (1) a pilot is not assigned to operate an aeroplane as part of the minimum certificated crew, either as pilot flying or pilot monitoring, unless he/she has carried out three take-offs and three landings in the previous 90 days as pilot flying in an aeroplane, or in a flight simulator, of the same type/class.
 - (2) a pilot who does not hold a valid instrument rating is not assigned to operate an aeroplane at night as commander unless he/she has carried out at least one landing at night in the preceding 90 days as pilot flying in an aeroplane, or in a flight simulator, of the same type/class.
- (b) The 90 day period prescribed in sub-paragraphs (a)(1) and (2) above may be extended up to a maximum of 120 days by line flying under the supervision of a Type Rating Instructor or Examiner. For periods beyond 120 days, the recency requirement is satisfied by a training flight or use of a Flight Simulator of the aeroplane type to be used.

OPS 1.975 Route and Aerodrome Competence Qualification

(See AMC OPS 1.975)

- (a) The operator shall ensure that, prior to being assigned as commander or as pilot to whom the conduct of the flight may be delegated by the commander, the pilot has obtained adequate knowledge of the route to be flown and of the aerodromes (including alternates), facilities and procedures to be used.
- (b) Each such pilot shall demonstrate to the operator an adequate knowledge of the route to be flown, and the aerodromes which are to be used. This shall include knowledge of;
 - (1) the terrain and minimum safe altitudes;
 - (2) the seasonal meteorological conditions;
 - (3) the meteorological, communication and air traffic facilities, services and procedures;
 - (4) the search and rescue procedures;
 - (5) the navigational facilities and procedures, including any long-range navigation procedures, associated with the route along which the flight is to take place; and
 - (6) procedures applicable to flight paths over heavily populated areas and areas of high air traffic density, obstructions, physical layout, lighting, approach aids and arrival, departure, holding and instrument approach procedures, and applicable operating minima.

Note: That portion of the demonstration relating to arrival, departure, holding and instrument approach procedures may be accomplished in an appropriate training device which is adequate for this purpose.



- (c) A pilot-in-command shall have made an actual approach into each aerodrome of landing on the route, accompanied by a pilot who is qualified for the aerodrome, as a member of the flight crew or as an observer on the flight deck, unless:
- (1) the approach to the aerodrome is not over difficult terrain and the instrument approach procedures and aids available are similar to those with which the pilot is familiar, and a margin to be approved by the Authority is added to the normal operating minima, or there is reasonable certainty that approach and landing can be made in visual meteorological conditions;
 - (2) the descent from the initial approach altitude can be made by day in visual meteorological conditions;
 - (3) the operator qualifies the pilot-in-command to land at the aerodrome concerned by means of an adequate pictorial presentation; or
 - (4) the aerodrome concerned is adjacent to another aerodrome at which the pilot-in-command is currently qualified to land.
- (d) The operator shall maintain a record, sufficient to satisfy the Authority of the qualification of the pilot and of the manner in which such qualification has been achieved.
- (e) The operator shall not continue to utilise a pilot as a pilot-in-command on a route or within an area specified by the operator and approved by the Authority unless, within the preceding 12 months, that pilot has made at least one trip as a pilot member of the flight crew, or as a check pilot, or as an observer in the flight crew compartment;
- (1) within that specified area; and
 - (2) if appropriate, on any route where procedures associated with that route or with any aerodromes intended to be used for take-off or landing require the application of special skills or knowledge.
- (f) In the event that more than the period of validity elapses in which a pilot-in-command has not made such a trip on a route in close proximity and over similar terrain, within such a specified area, route or aerodrome, and has not practised such procedures in a training device which is adequate for this purpose, prior to again serving as a pilot-in-command within that area or on that route, that pilot must requalify in accordance with (b) and (c).
- (g) The period of validity of the route and aerodrome competence qualification shall be 12 calendar months in addition to the remainder of:
- (1) the month of qualification; or
 - (2) the month of the latest operation on the route or to the aerodrome.
- (h) Route and aerodrome competence qualification shall be revalidated by operating on the route or to the aerodrome within the period of validity prescribed in sub-paragraph (g) above.
- (i) If revalidated within the final 3 calendar months of validity of previous route and aerodrome competence qualification, the period of validity shall extend from the date of revalidation until 12 calendar months from the expiry date of that previous route and aerodrome competence qualification.

**OPS 1.978 Alternative Training and Qualification Programme**

(See Appendix 1 to OPS 1.978)

(See AC OPS 1.978)

- (a) The operator, following a minimum of two years continuous operations, may substitute the training and checking requirements for flight crew specified in Appendix 1 to OPS 1.978(a) by an Alternative Training and Qualification Programme (ATQP) approved by the Authority. The two years continuous operations may be reduced at the discretion of the Authority.
- (b) The ATQP must contain training and checking which establishes and maintains a level of proficiency demonstrated to be at least not less than the level of proficiency achieved by following the provisions of OPS 1.945, 1.965 and 1.970. The standard of flight crew training and qualification shall be established prior to the introduction of ATQP; the required ATQP training and qualification standards shall also be specified.
- (c) The operator applying for approval to implement an ATQP shall provide the Authority with an implementation plan in accordance with paragraph (c) of Appendix 1 to OPS 1.978.
- (d) In addition to the checks required by OPS 1.965 and OPS 1.970 the operator shall ensure that each flight crew member undergoes a Line Orientated Evaluation (LOE).
 - (1) The Line Orientated Evaluation (LOE) shall be conducted in a simulator. The LOE may be undertaken with other approved ATQP training.
 - (2) The period of validity of a LOE shall be 12 calendar months, in addition to the remainder of the month of issue. If issued within the final 3 calendar months of validity of a previous LOE the period of validity shall extend from the date of issue until 12 calendar months from the expiry date of that previous LOE.
- (e) After 2 years of operating within an approved ATQP the operator may, with the approval of the Authority, extend the periods of validity of OPS 1.965 and 1.970 as follows:
 - (1) Operator proficiency check – 12 calendar months in addition to the remainder of the month of issue. If issued within the final 3 calendar months of validity of a previous operator proficiency check, the period of validity shall extend from the date of issue until 12 calendar months from the expiry date of that previous operator proficiency check.
 - (2) Line Check - 24 calendar months in addition to the remainder of the month of issue. If issued within the final 6 calendar months of validity of a previous line check, the period of validity shall extend from the date of issue until 24 calendar months from the expiry date of that previous line check. The line check may be combined with a Line Oriented Quality Evaluation (LOQE) with the approval of the authority.
 - (3) Emergency and Safety equipment checking – 24 calendar months in addition to the remainder of the month of issue. If issued within the final 6 calendar months of validity of a previous check, the period of validity shall extend from the date of issue until 24 calendar months from the expiry date of that previous check.
- (f) The ATQP shall be the responsibility of a nominated post holder.

OPS 1.980 Operation on More than One Type or Variant

(See Appendix 1 to OPS 1.980)

(See AMC OPS 1.980)



- (a) The operator shall ensure that a flight crew member does not operate on more than one type or variant, unless: the flight crew member is competent to do so.
- (b) When considering operations of more than one type or variant, the operator shall ensure that the differences and/or similarities of the aeroplanes concerned justify such operations, taking account of the following:
 - (1) The level of technology;
 - (2) Operational procedures;
 - (3) Handling characteristics.
(See AMC OPS 1.980(b) and AMC OPS 1.980(b))
- (c) The operator shall ensure that a flight crew member operating more than one type or variant complies with all of the requirements prescribed in Subpart N for each type or variant unless the Authority has approved the use of credit(s) related to the training, checking and recent experience requirements.
- (d) The operator shall specify appropriate procedures and/or operational restrictions, approved by the Authority, in the Operations Manual, for any operation on more than one type or variant covering:
 - (1) The flight crew members' minimum experience level;
 - (2) The minimum experience level on one type or variant before beginning training for and operation of another type or variant;
 - (3) The process whereby flight crew qualified on one type or variant will be trained and qualified on another type or variant; and
 - (4) All applicable recent experience requirements for each type or variant.

OPS 1.981 Operation of Helicopters and Aeroplanes

- (a) When a flight crew member operates both helicopters and aeroplanes:
 - (1) The operator shall ensure that operations of helicopter and aeroplane are limited to one type of each.
 - (2) The operator shall specify appropriate procedures and/or operational restrictions, approved by the Authority, in the Operations Manual.

OPS 1.985 Training Records

(See AMC OPS 1.985)

- (a) The operator shall;
 - (1) maintain records of all training, checking and qualification prescribed in OPS 1.945, OPS 1.955, OPS 1.965, OPS 1.968 and OPS 1.975 undertaken by a flight crew member; and
 - (2) make the records of all conversion courses and recurrent training and checking available, on request, to the flight crew member concerned.



Appendix 1 to OPS 1.940

In-flight Relief of Flight Crew Members

- (a) A flight crew member may be relieved in flight of his duties at the controls by another suitably qualified flight crew member.
- (b) *Relief of the Commander*
 - (1) The commander may delegate conduct of the flight to:
 - (i) another qualified commander; or
 - (ii) for operations only above FL200, a pilot qualified as detailed in sub-paragraph (c) below.
- (c) *Minimum requirements for a pilot relieving the commander*
 - (1) Valid Airline Transport Pilot Licence;
 - (2) Conversion training and checking, including Type Rating training as prescribed in OPS 1.945;
 - (3) All recurrent training and checking as prescribed in OPS 1.965 and OPS 1.968; and
 - (4) Route competence qualification as prescribed in OPS 1.975.
- (d) *Relief of the co-pilot*
 - (1) The co-pilot may be relieved by:
 - (i) another suitably qualified pilot; or
 - (ii) a cruise relief co-pilot qualified as detailed in sub-paragraph (e) below.
- (e) *Minimum requirements for Cruise Relief Co-Pilot*
 - (1) Valid Commercial Pilot Licence with Instrument Rating;
 - (2) Conversion training and checking, including Type Rating training, as prescribed in OPS 1.945 except the requirement for take-off and landing training;
 - (3) All recurrent training and checking as prescribed in OPS 1.965 except the requirement for take-off and landing training; and
 - (4) To operate in the role of co-pilot in the cruise only and not below FL 200.
 - (5) Recent experience as prescribed in OPS 1.970 is not required. The pilot shall, however, carry out Flight Simulator recency and refresher flying skill training at intervals not exceeding 90 days. This refresher training may be combined with the training prescribed in OPS 1.965.



- (f) *Relief of the system panel operator.* A system panel operator may be relieved in flight by a crew member who holds a Flight Engineer's licence or by a flight crew member with a qualification acceptable to the Authority.



Appendix 2 to OPS 1.940

Single-pilot Operations under IFR or at Night

- (a) Aeroplanes referred to in OPS 1.940(b)(2) may be operated by a single-pilot under IFR or at night when the following requirements are satisfied:
- (1) The operator shall include in the Operations Manual a pilot's conversion and recurrent training programme which includes the additional requirements for a single-pilot operation;
 - (2) In particular, the cockpit procedures must include:
 - (i) Engine management and emergency handling;
 - (ii) Use of normal, abnormal and emergency checklists;
 - (iii) ATC communication;
 - (iv) Departure and approach procedures;
 - (v) Autopilot management; and
 - (vi) Use of simplified in-flight documentation;
 - (3) The recurrent checks required by OPS 1.965 shall be performed in the single-pilot role on the type or class of aeroplane in an environment representative of the operation;
 - (4) The pilot shall have a minimum of 50 hours flight time on the specific type or class of aeroplane under IFR of which 10 hours is as commander; and
 - (5) The minimum required recent experience for a pilot engaged in a single-pilot operation under IFR or at night shall be 5 IFR flights, including 3 instrument approaches, carried out during the preceding 90 days on the type or class of aeroplane in the single-pilot role. This requirement may be replaced by an IFR instrument approach check on the type or class of aeroplane.



Appendix 1 to OPS 1.945
Operator's Conversion Course

(See AMC OPS 1.945)

(See AC OPS (AMC) 1.943/1.945(a)(9)/1.955(b)(6)/1.965(e))

(See AC OPS (AMC) 1.943/1.945(a)(9)/1.955(b)(6)/1.965(e))

(See AMC OPS 1.945)

- (a) The operator's conversion course shall include;
- (1) ground training and checking including aeroplane systems, normal, abnormal and emergency procedures;
 - (2) emergency and safety equipment training and checking which must be completed before aeroplane training commences;
 - (3) aeroplane/flight simulator training and checking; and
 - (4) line flying under supervision and line check.
- (b) The conversion course shall be conducted in the order set out in sub-paragraph (a) above.
- (c) Elements of Crew Resource Management shall be integrated into the conversion course, and conducted by suitably qualified personnel.
- (d) When a flight crew member has not previously completed the operator's conversion course, the operator shall ensure that in addition to sub-paragraph (a) above, the flight crew member undergoes general first aid training and, if applicable, ditching procedures training using the equipment in water.

**Appendix 1 to OPS 1.965****Recurrent Training and Checking – Pilots**

(See AMC OPS 1.965(c))

(See AC OPS (AMC) 1.943/1.945(a)(9)/1.955(b)(6)/1.965(e))

(See AC OPS (AMC) 1.943/1.945(a)(9)/1.955(b)(6)/1.965(e))

(See AMC OPS 1.965)

- (a) Recurrent Training – Recurrent training shall comprise:
- (1) Ground and refresher training
 - (i) The ground and refresher training programme shall include:
 - (A) Aeroplane systems;
 - (B) Operational procedures and requirements including ground de-/anti-icing (See AMC OPS 1.345(a)) and pilot incapacitation (see AMC to Appendix 1 to OPS 1.965); and
 - (C) Accident/Incident and occurrence review.
 - (ii) Knowledge of the ground and refresher training shall be verified by a questionnaire or other suitable methods.
 - (2) Aeroplane/FSTD training
 - (i) The aeroplane/FSTD training programme shall be established such that all major failures of aeroplane systems and associated procedures will have been covered in the preceding 3 year period.
 - (ii) When engine-out manoeuvres are carried out in an aeroplane, the engine failure shall be simulated.
 - (iii) Aeroplane/FSTD training may be combined with the operator proficiency check.
 - (3) Emergency and Safety Equipment Training
 - (i) Emergency and safety equipment training may be combined with emergency and safety equipment checking and shall be conducted in an aeroplane or a suitable alternative training device.
 - (ii) Every year the emergency and safety equipment training programme must include the following:
 - (A) Actual donning of a lifejacket where fitted;
 - (B) Actual donning of protective breathing equipment where fitted;
 - (C) Actual handling of fire extinguishers;
 - (D) Instruction on the location and use of all emergency and safety equipment carried on the aeroplane;



- (E) Instruction on the location and use of all types of exits; and
 - (F) Security procedures.
- (iii) Every 3 years the programme of training must include the following:
- (A) Actual operation of all types of exits;
 - (B) Demonstration of the method used to operate a slide where fitted;
 - (C) Actual fire-fighting using equipment representative of that carried in the aeroplane on an actual or simulated fire except that, with Halon extinguishers, an alternative method acceptable to the Authority may be used;
 - (D) The effects of smoke in an enclosed area and actual use of all relevant equipment in a simulated smoke-filled environment;
 - (E) Actual handling of pyrotechnics, real or simulated, where fitted; and
 - (F) Demonstration in the use of the life-raft(s) where fitted.
- (4) *Crew Resource Management (CRM)* .
- (i) Elements of CRM shall be integrated into all appropriate phases of recurrent training; and
 - (ii) A specific modular CRM training programme shall be established such that all major topics of CRM training are covered over a period not exceeding 3 years, as follows:
 - (A) Human error and reliability, error chain, error prevention and detection;
 - (B) Company safety culture, SOPs, organisational factors;
 - (C) Stress, stress management, fatigue and vigilance;
 - (D) Information acquisition and processing, situation awareness, workload management;
 - (E) Decision making;
 - (F) Communication and co-ordination inside and outside the cockpit;
 - (G) Leadership and team behaviour, synergy;
 - (H) Automation and philosophy of the use of automation (if relevant to the type);
 - (I) Specific type-related differences;
 - (J) Case-based studies;



- (K) Additional areas which warrant extra attention, as identified by the safety management system (see OPS 1.037).
- (iii) Operators shall establish procedures to update their CRM recurrent training programme. Revision of the Programme shall be conducted over a period not exceeding 3 years. The revision of the programme shall take into account the de-identified results of the CRM assessments of crews, and information identified by the safety management system.).
- (b) *Recurrent checking.* Recurrent checking shall comprise:
- (1) *Operator proficiency checks*
- (i) Where applicable, operator proficiency checks shall include the following manoeuvres:
- (A) Rejected take-off when a Flight Simulator is available to represent that specific aeroplane, otherwise touch drills only;
- (B) Take-off with engine failure between V_1 and V_2 or as soon as safety considerations permit;
- (C) Precision instrument approach to minima with, in the case of multi-engine aeroplanes, one-engine-inoperative;
- (D) Non-precision approach to minima;
- (E) Missed approach on instruments from minima with, in the case of multi-engine aeroplanes, one-engine-inoperative; and
- (F) Landing with one-engine-inoperative. For Single-engine aeroplanes a practice forced landing is required.
- (ii) When engine out manoeuvres are carried out in an aeroplane, the engine failure must be simulated.
- (iii) In addition to the checks prescribed in sub-paragraphs (i)(A) to (F) above, the requirements applicable to the revalidation or renewal of the aircraft Type or Class Rating must be completed every 12 months and may be combined with the operator proficiency check.
- (iv) For a pilot operating VFR only, the checks prescribed in sub-paragraphs (i)(C) to (E) above may be omitted except for an approach and go-around in a multi-engine aeroplane with one-engine-inoperative.
- (v) Operator proficiency checks must be conducted by an Examiner. (See OPS 1.965(a)(4)(i))
- (2) *Emergency and safety equipment checks.* The items to be checked shall be those for which training has been carried out in accordance with sub-paragraph (a)(3) above.



- (3) *Line checks;*
- (i) Line checks must establish the ability to perform satisfactorily a complete line operation including pre-flight and post-flight procedures and use of the equipment provided, as specified in the Operations Manual.
 - (ii) The flight crew must be assessed on their CRM skills in accordance with a methodology acceptable to the Authority and published in the Operations Manual. The purpose of such assessment is to;
 - (A) provide feedback to the crew collectively and individually and serve to identify retraining; and
 - (B) be used to improve the CRM training system.
 - (iii) CRM assessment alone shall not be used as a reason for a failure of the line check.
 - (iv) When pilots are assigned duties as pilot flying and pilot monitoring they must be checked in both functions.
 - (v) Line checks must be completed in an aeroplane.
 - (vi) Line checks must be conducted by commanders nominated by the operator and acceptable to the Authority. The person conducting the line check, who is described in OPS 1.965(a)(4)(ii), shall be trained in CRM concepts and the assessment of CRM skills and should occupy an observer's seat where installed. In the case of long haul operations where additional operating flight crew are carried, the person may fulfil the function of a cruise relief pilot and shall not occupy either pilot's seat during take-off, departure, initial cruise, descent, approach and landing. His/her CRM assessments shall solely be based on observations made during the initial briefing, cabin briefing, cockpit briefing and those phases where he/she occupies the observer's seat.

**Appendix 2 to OPS 1.965****Recurrent Training and Checking – System Panel Operators**

- (a) The recurrent training and checking for System Panel Operators shall meet the requirements for pilots and any additional specific duties, omitting those items that do not apply to System Panel Operators.
- (b) Recurrent training and checking for System Panel Operators shall, whenever possible, take place concurrently with a pilot undergoing recurrent training and checking.
- (c) A line check shall be conducted by a commander nominated by the operator and acceptable to the Authority or by a System Panel Operator Type Rating Instructor or Examiner.

**Appendix 1 to OPS 1.968****Pilot Qualification to Operate in Either Pilot's Seat**

- (a) Commanders whose duties also require them to operate in the right-hand seat and carry out the duties of co-pilot, or commanders required to conduct training or examining duties from the right-hand seat, shall complete additional training and checking as specified in the Operations Manual, concurrent with the operator proficiency checks prescribed in OPS 1.965(b). This additional training must include at least the following:
 - (1) An engine failure during take-off;
 - (2) A one-engine-inoperative approach and go-around; and
 - (3) A one-engine-inoperative landing.
- (b) When engine-out manoeuvres are carried out in an aeroplane, the engine failure must be simulated.
- (c) When operating in the right-hand seat, the checks required by OPS 1 for operating in the left-hand seat must, in addition, be valid and current.
- (d) A pilot relieving the commander shall have demonstrated, concurrent with the operator proficiency checks prescribed in OPS 1.965(b), practice of drills and procedures which would not, normally, be the relieving pilot's responsibility. Where the differences between left and right seats are not significant (for example because of use of autopilot) then practice may be conducted in either seat.
- (e) A pilot other than the commander occupying the left-hand seat shall demonstrate practice of drills and procedures, concurrent with the operator proficiency checks prescribed in OPS 1.965(b), which would otherwise have been the commander's responsibility acting as pilot monitoring. Where the differences between left and right seats are not significant (for example because of use of autopilot) then practice may be conducted in either seat.

**Appendix 1 to OPS 1.978****Alternative Training and Qualification Programme**

(See AC to Appendix 1 to OPS 1.978(b)(1))

(See AC to Appendix 1 to OPS 1.978(b)(2))

(See AC to Appendix 1 to OPS 1.978(b)(3))

(See AC to Appendix 1 to OPS 1.978(b)(4))

(See AC to Appendix 1 to OPS 1.978(b)(5))

(See AC to Appendix 1 to OPS 1.978(b)(6))

(See AC to Appendix 1 to OPS 1.978(b)(9))

(See AC to Appendix 1 to OPS 1.978(c)(1)(i))

- (a) The operator's ATQP may apply to the following requirements that relate to training and qualifications:
- (1) OPS 1.450 and Appendix 1 to OPS 1.450 - Low Visibility Operations – Training and Qualifications;
 - (2) OPS 1.945 Conversion training and checking and Appendix 1 to OPS 1.945;
 - (3) OPS 1.950 Differences training and familiarisation training;
 - (4) OPS 1.955 paragraph (b) -Nomination as commander;
 - (5) OPS 1.965 Recurrent training and checking and Appendices 1 and 2 to OPS 1.965;
 - (6) OPS 1.980 Operation on more than one type or variant and Appendix 1 to OPS 1.980.
- (b) Components of the ATQP - An Alternative Training and Qualification Programme shall comprise the following:
- (1) Documentation that details the scope and requirements of the programme;
 - (2) A task analysis to determine the tasks to be analysed in terms of:
 - (i) knowledge;
 - (ii) the required skills;
 - (iii) the associated skill-based training; and, where appropriate
 - (iv) the validated behavioural markers.
 - (3) Curricula – the curriculum structure and content shall be determined by task analysis, and shall include proficiency objectives including when and how those objectives shall be met. The process for curriculum development shall be acceptable to the Authority;
 - (4) A specific training programme for:
 - (i) each aeroplane type/class within the ATQP;
 - (ii) the instructors (CRI/SFI/TRI), and other personnel undertaking flight crew instruction;



- (iii) the examiners (CRE/SFE/TRE); to include a method for the standardisation of the instructors and examiners;
 - (5) A feedback loop for the purpose of curriculum validation and refinement, and to ascertain that the programme meets its proficiency objectives;
 - (6) A method for the assessment of flight crew both during conversion and recurrent training and checking. The assessment process shall include event-based assessment as part of the LOE. The method of assessment shall comply with the provisions of OPS 1.965;
 - (7) An integrated system of quality control, that ensures compliance with all the requirements processes and procedures of the programme;
 - (8) A process that describes the method to be used if the monitoring and evaluation programmes do not ensure compliance with the established proficiency and qualification standards for flight crew;
 - (9) A Data Monitoring/Analysis programme.
- (c) Implementation - the operator shall develop an evaluation and implementation strategy acceptable to the Authority; the following requirements shall be fulfilled:
- (1) The implementation process shall include the following stages:
 - (i) A safety case that substantiates the validity of:
 - (A) The revised training and qualification standards when compared with the standards achieved under OPS 1 prior to the introduction of ATQP.
 - (B) Any new training methods implemented as part of ATQP. If approved by the Authority the operator may establish an equivalent method other than a formal safety case.
 - (ii) Undertake a task analysis as required by paragraph (b)(2) above in order to establish the operator's programme of targeted training and the associated training objectives.
 - (iii) A period of operation whilst data is collected and analysed to ensure the efficacy of the safety case or equivalent and validate the task analysis. During this period the operator shall continue to operate to the pre-ATQP OPS 1 requirements. The length of this period shall be agreed with the authority;
 - (2) The operator may then be approved to conduct training and qualification as specified under the ATQP.

**Appendix 1 to OPS 1.980****Operation on More than One Type or Variant**

(See AMC OPS 1.980)

- (a) When a flight crew member operates more than one aeroplane class, type or variant and associated procedures for class-single-pilot and/or associated procedures for type-single-pilot, but not within a single licence endorsement, the operator must comply with the following:
- (1) A flight crew member shall not operate more than;
 - (i) three piston engine aeroplane types or variants; or
 - (ii) three turbo-propeller aeroplane types or variants; or
 - (iii) one turbo-propeller aeroplane type or variant and one piston engine aeroplane type or variant; or.
 - (iv) one turbo-propeller aeroplane type or variant and any aeroplane within a particular class.
 - (2) OPS 1.965 for each type or variant operated unless the operator has demonstrated specific procedures and/or operational restrictions which are acceptable to the Authority.
- (b) When a flight crew member operates more than one aeroplane type or variant within one or more licence endorsement and associated procedures for type-multi pilot, the operator shall ensure that;
- (1) the minimum flight crew complement specified in the Operations Manual is the same for each type or variant to be operated;
 - (2) a flight crew member does not operate more than two aeroplane types or variants for which a separate licence endorsement is required; and
 - (3) only aeroplanes within one licence endorsement are flown in any one flight duty period unless the operator has established procedures to ensure adequate time for preparation.
- Note: In cases where more than one licence endorsement is involved, see sub-paragraphs (c) and (d) below.*
- (c) When a flight crew member operates more than one aeroplane type or variant and associated procedures for type-single-pilot and type-multi pilot, but not within a single licence endorsement, the operator must comply with;
- (1) subparagraphs (b)(1), (b)(2) and (b)(3) above; and
 - (2) subparagraph (d) below.
- (d) When a flight crew member operates more than one aeroplane type or variant and associated procedures for type-multi pilot, but not within a single licence endorsement, the operator must comply with the following;
- (1) subparagraphs (b)(1), (b)(2) and (b)(3) above;



- (2) before exercising the privileges of 2 licence endorsements:
 - (i) flight crew members must have completed two consecutive operator proficiency checks and must have 500 hours in the relevant crew position in commercial air transport operations with the same operator.
 - (ii) in the case of a pilot having experience with the operator and exercising the privileges of 2 licence endorsements, and then being promoted to command with the same operator on one of those types, the required minimum experience as commander is 6 months and 300 hours, and the pilot must have completed 2 consecutive operator proficiency checks before again being eligible to exercise 2 licence endorsements.
- (3) before commencing training for and operation of another type or variant, flight crew members must have completed 3 months and 150 hours flying on the base aeroplane which must include at least one proficiency check.
- (4) after completion of the initial line check on the new type, 50 hours flying or 20 sectors must be achieved solely on aeroplanes of the new type rating.
- (5) OPS 1.970 for each type operated unless credits have been allowed by the Authority in accordance with sub-paragraph (7) below.
- (6) the period within which line flying experience is required on each type must be specified in the Operations Manual.
- (7) where credits are sought to reduce the training and checking and recent experience requirements between aeroplane types, the operator must demonstrate to the Authority which items need not be repeated on each type or variant because of similarities (See AMC OPS 1.980(b) and AMC OPS 1.980(b)).
 - (i) OPS 1.965(b) requires two operator proficiency checks every year. When credit is given in accordance with sub-paragraph (7) above for operator proficiency checks to alternate between the two types, each operator proficiency check revalidates the operator proficiency check for the other type. Provided that the period between proficiency checks for revalidation or renewal of type rating does not exceed the requirements for each type. In addition relevant and approved recurrent training must be specified in the Operations Manual.
 - (ii) OPS 1.965(c) requires one line check every year. When credit is given in accordance with sub-paragraph (7) above for line checks to alternate between types or variants, each line check revalidates the line check for the other type or variant.
 - (iii) Annual emergency and safety equipment training and checking must cover all requirements for each type.
- (8) OPS 1.965 for each type or variant operated unless credits have been allowed by the Authority in accordance with sub-paragraph (7) above.
- (e) When a flight crew member operates combinations of aeroplane types or variants and associated procedures for class-single-pilot and for type-multi pilot, the operator must demonstrate that specific procedures and/or operational restrictions are approved in accordance with OPS 1.980(d).



This Page Intentionally Left Blank

**SUBPART O****CABIN CREW****OPS 1.988 Applicability**

The operator shall ensure that all cabin crew members comply with the requirements of this Subpart and any other safety requirements applicable to cabin crew.

For the purpose of this Regulation, “cabin crew member” means any crew member, other than a flight crew member, who performs, in the interests of safety of passengers, duties assigned to him/her by the operator or the commander in the cabin of an aeroplane.

OPS 1.989 Identification

- (a) The operator shall ensure that all cabin crew members wear the operator’s cabin crew uniform and are clearly identifiable to the passengers as a cabin crew member.
- (b) Other personnel, such as medical staff, security staff, child minders, escorts, technical staff, entertainers, interpreters, who undertake tasks in the cabin, shall not wear a uniform which might identify them to passengers as a cabin crew member, unless they comply with the requirements of this Subpart and any other applicable requirements of this Regulation.

OPS 1.990 Number and Composition of Cabin Crew

(See AMC OPS 1.990)

- (a) The operator shall not operate an aeroplane with a maximum approved passenger seating configuration of more than 19, when carrying one or more passengers, unless at least one cabin crew member is included in the crew for the purpose of performing duties, specified in the Operations Manual, in the interests of the safety of passengers.
- (b) When complying with sub-paragraph (a) above, the operator shall ensure that the minimum number of cabin crew is the greater of;
 - (1) one cabin crew member for every 50, or fraction of 50, passenger seats installed on the same deck of the aeroplane; or
 - (2) the number of cabin crew who actively participated in the aeroplane cabin during the relevant emergency evacuation demonstration, or who were assumed to have taken part in the relevant analysis, except that, if the maximum approved passenger seating configuration is less than the number evacuated during the demonstration by at least 50 seats, the number of cabin crew may be reduced by 1 for every whole multiple of 50 seats by which the maximum approved passenger seating configuration falls below the certificated maximum capacity.
- (c) The Authority may under exceptional circumstances require the operator to include in the crew additional cabin crew members.
- (d) In unforeseen circumstances the required minimum number of cabin crew may be reduced provided that;
 - (1) the number of passengers has been reduced in accordance with procedures specified in the Operations Manual; and



- (2) a report is submitted to the Authority after completion of the flight.
- (e) The operator shall ensure that when engaging the services of cabin crew members who are self-employed and/or working on a freelance or part-time basis, the requirements of Subpart O are complied with. In this respect, particular attention must be paid to the total number of aircraft types or variants that a cabin crew member may fly for the purposes of commercial air transportation, which must not exceed the requirements prescribed in OPS 1.1030, including when his/her services are engaged by another operator.

OPS 1.995 Minimum Requirements

(See AMC OPS 1.995(b))

The operator shall ensure that each cabin crew member:

- (a) is at least 18 years of age;
- (b) has passed a medical examination or assessment at regular intervals as required by the Authority so as to check the medical fitness to discharge his/her duties;
- (c) has successfully completed initial training in accordance with OPS 1.1005 and holds an attestation of safety training;
- (d) has completed the appropriate conversion and/or differences training covering at least the subjects listed in OPS 1.1010;
- (e) shall undergo recurrent training in line with the provisions of OPS 1.1015;
- (f) is competent to perform his/her duties in accordance with procedures specified in the Operations Manual.

OPS 1.1000 Senior Cabin Crew Members

- (a) The operator shall nominate a senior cabin crew member whenever more than one cabin crew member is assigned. For operations when more than one cabin crew member is assigned, but only one cabin crew member is required, the operator shall nominate one cabin crew member to be responsible to the commander.
- (b) The senior cabin crew member shall have responsibility to the commander for the conduct and co-ordination of normal and emergency procedure(s) specified in the Operations Manual. During turbulence, in the absence of any instructions from the flight crew, the senior cabin crew member shall be entitled to discontinue non-safety-related duties and advise the flight crew of the level of turbulence being experienced and the need for the fasten seat belt signs to be switched on. This should be followed by the cabin crew securing the passenger cabin and other applicable areas.
- (c) Where required by OPS 1.990 to carry more than one cabin crew member, the operator shall not appoint a person to the post of senior cabin crew member unless that person has at least one year's experience as an operating cabin crew member and has completed an appropriate course covering the following as a minimum (See AMC OPS 1.1000 (c).):
 - (1) pre-flight briefing:
 - (i) operating as a crew,



- (ii) allocation of cabin crew stations and responsibilities,
 - (iii) consideration of the particular flight, including aeroplane type, equipment, area and type of operation, and categories of passengers with particular attention to disabled, infants and stretcher cases, and
- (2) cooperation within the crew:
- (i) discipline, responsibilities and chain of command,
 - (ii) importance of coordination and communication,
 - (iii) pilot incapacitation, and
- (3) review of operator's requirements and legal requirements:
- (i) passenger safety briefing, safety cards,
 - (ii) securing of galleys,
 - (iii) stowage of cabin baggage,
 - (iv) electronic equipment,
 - (v) procedures when fuelling with passengers on board,
 - (vi) turbulence,
 - (vii) documentation, and
- (4) human factors and crew resource management, and
- (5) accident and incident reporting, and
- (6) flight and duty time limitations and rest requirements.
- (d) The operator shall establish procedures to select the next most suitably qualified cabin crew member to operate as senior cabin crew member in the event of the nominated senior cabin crew member becoming unable to operate. Such procedures must be acceptable to the Authority and take account of a cabin crew member's operational experience.
- (e) CRM Training: the operator shall ensure that all relevant elements in Appendix 2 to OPS 1.1005/1.1010/1.1015 Table 1, Column (a) are integrated into the training and covered to the level required by Column (f), Senior Cabin Crew Course.

OPS 1.1002 Single Cabin Crew Operations

- (a) The operator shall ensure that each cabin crew member who does not have previous comparable experience completes the following before operating as a single cabin crew member:
- (1) Training in addition to that required by OPS 1.1005 and OPS 1.1010 shall include particular emphasis on the following to reflect single cabin crew operations:



- (i) Responsibility to the commander for the conduct of cabin safety and emergency procedure(s) specified in the Operations Manual,
 - (ii) Importance of co-ordination and communication with the flight crew, management of unruly or disruptive passengers,
 - (iii) Review of operator's requirements and legal requirements,
 - (iv) Documentation,
 - (v) Accident and incident reporting,
 - (vi) Flight and duty time limitations.
- (2) Familiarisation flying of at least 20 hours and 15 sectors. Familiarisation flights shall be conducted under the supervision of a suitably experienced cabin crew member on the aeroplane type to be operated. (See AMC OPS 1.1012).
- (b) The operator shall ensure, before a cabin crew member is assigned to operate as a single cabin crew member, that this cabin crew member is competent to perform his/her duties in accordance with the procedures specified in the Operations Manual. Suitability for single cabin crew operations shall be addressed in the criteria for cabin crew selection, recruitment, training and assessment of competence.

OPS 1.1003 Cabin Crew Training

- (a) The operator shall establish and maintain a training programme, approved by the Authority, to be completed by all persons before being assigned as a cabin crew member. Cabin crew members shall complete a recurrent training programme annually. These training programmes shall ensure that each person is:
- (1) competent to execute those safety duties and functions which the cabin crew member is assigned to perform in the event of an emergency or in a situation requiring emergency evacuation;
 - (2) drilled and capable in the use of emergency and life-saving equipment required to be carried, such as life jackets, life rafts, evacuation slides, emergency exits, portable fire extinguishers, oxygen equipment, first-aid and universal precaution kits, and automated external defibrillators;
 - (3) when serving on aeroplanes operated above 3000 m (10000 ft), knowledgeable as regards the effect of lack of oxygen and, in the case of pressurised aeroplanes, as regards physiological phenomena accompanying a loss of pressurisation;
 - (4) aware of other crew members' assignments and functions in the event of an emergency so far as is necessary for the fulfilment of the cabin crew member's own duties;
 - (5) aware of the types of dangerous goods which may, and may not, be carried in a passenger cabin; and
 - (6) knowledgeable about human performance as related to passenger cabin safety duties including flight crew-cabin crew coordination.

**OPS 1.1005 Initial Safety Training**

(See Appendix 1 to OPS 1.1005)

(See Appendix 3 to OPS 1.1005/1.1010/1.1015)

(See AC OPS 1.1005/1.1010/1.1015)

(See AC OPS 1.1005/1.1010/1.1015/1.1020)

- (a) The operator shall ensure that each cabin crew member has, before undertaking conversion training, successfully completed initial safety training covering at least the subjects listed in Appendix 1 to OPS 1.1005.
- (b) Training courses shall, at the discretion of the Authority, and subject to its approval, be provided: either
 - (1) by the operator
 - directly, or
 - indirectly through a training organisation acting on behalf of the operator; or
 - (2) by an approved training organisation.
- (c) The programme and structure of the initial training courses shall be in accordance with the applicable requirements and shall be subject to prior approval of the Authority.
- (d) The operator or the approved training organisation providing the training course, shall deliver an attestation of safety training to a cabin crew member after he/she has completed the initial safety training and successfully passed the check referred to in OPS 1.1025.
- (e) Where the Authority authorises the operator or an approved training organisation to deliver the attestation of safety training to a cabin crew member, such attestation shall clearly state a reference to the approval of the Authority.

OPS 1.1010 Conversion and Differences training

(See Appendix 1 to OPS 1.1010)

(See Appendix 3 to OPS 1.1005/1.1010/1.1015/1.1020)

(See AC OPS 1.1005/1.1010/1.1015/1.1020)

- (a) The operator shall ensure that each cabin crew member has completed appropriate conversion and differences training, in accordance with the applicable rules and at least the subjects listed in Appendix 1 to OPS 1.1010. The training course shall be specified in the Operations Manual. The programme and structure of the training course shall be subject to prior approval by the Authority.
 - (1) *Conversion training*; A conversion course must be completed before being:
 - (i) first assigned by the operator to operate as a cabin crew member; or
 - (ii) assigned to operate another aeroplane type; and
 - (2) *Differences training*. Differences training must be completed before operating:
 - (i) on a variant of an aeroplane type currently operated; or



- (ii) with different safety equipment, safety equipment location, or normal and emergency procedures on currently operated aeroplane types or variants.
- (b) The operator shall determine the content of the conversion and differences training taking account of the cabin crew member's previous training as recorded in the cabin crew member's training records required by OPS 1.1035.
- (c) Without prejudice to OPS 1.995(c), related elements of both initial training (OPS 1.1005) and conversion and differences training (OPS 1.1010) may be combined.
- (d) The operator shall ensure that:
 - (1) conversion training is conducted in a structured and realistic manner, in accordance with Appendix 1 to OPS 1.1010;
 - (2) differences training is conducted in a structured manner; and
 - (3) conversion training, and if necessary differences training, includes the use of all safety equipment and all normal and emergency procedures applicable to the type or variant of aeroplane and involves training and practice on either a representative training device or on the actual aeroplane.
- (e) The operator shall ensure that each cabin crew member before being first assigned to duties, completes the Operator's CRM Training and aeroplane type-specific CRM, in accordance with Appendix 1 to OPS 1.1010(j). Cabin crew who are already operating as cabin crew members with the operator, and who have not previously completed the Operator's CRM Training, shall complete this training by the time of the next required recurrent training and checking in accordance with Appendix 1 to OPS 1.1010(j), including aeroplane type-specific CRM, as relevant.

OPS 1.1012 Familiarisation

(See AMC OPS 1.1012)

The operator shall ensure that, following completion of conversion training, each cabin crew member completes familiarisation prior to operating as one of the minimum number of cabin crew required by OPS 1.990.

OPS 1.1015 Recurrent Training

(See Appendix 1 to OPS 1.1015)

(See Appendix 3 to OPS 1.1005/1.1010/1.1015)

(See AC OPS 1.1005/1.1010/1.1015)

(See AC OPS 1.1005/1.1010/1.1015/1.1020)

- (a) The operator shall ensure that each cabin crew member undergoes recurrent training, covering the actions assigned to each crew member in normal and emergency procedures and drills relevant to the type(s) and/or variant(s) of aeroplane on which they operate in accordance with Appendix 1 to OPS 1.1015.
- (b) The operator shall ensure that the recurrent training programme approved by the Authority includes theoretical and practical instruction, together with individual practice, as prescribed in Appendix 1 to OPS 1.1015.



- (c) The period of validity of recurrent training and the associated checking required by OPS 1.1025 shall be 12 calendar months in addition to the remainder of the month of issue. If issued within the final 3 calendar months of validity of a previous check, the period of validity shall extend from the date of issue until 12 calendar months from the expiry date of that previous check.

OPS 1.1020 Refresher Training

(See Appendix 1 to OPS 1.1020)

(See AMC OPS 1.1020)

(See AC OPS 1.1005/1.1010/1.1015/1.1020)

- (a) The operator shall ensure that each cabin crew member who has been absent from all flying duties for more than 6 months and still remains within the period of validity of the previous check required by OPS 1.1025(b)(3) completes refresher training specified in the Operations Manual as prescribed in Appendix 1 to OPS 1.1020 (See AMC OPS 1.1020(a)).
- (b) The operator shall ensure that when a cabin crew member has not been absent from all flying duties, but has not, during the preceding 6 months, undertaken duties on a type of aeroplane as a cabin crew member required by OPS 1.990(b), before undertaking such duties on that type, the cabin crew member either:
- (1) completes refresher training on the type; or
 - (2) operates two re-familiarisation sectors during commercial operations on the type.

OPS 1.1025 Checking

(See AMC OPS 1.1025)

- (a) At the discretion of the Authority, the operator or the approved training organisation providing the training course shall ensure that during or following completion of the training required by OPS 1.1005, OPS 1.1010 and OPS 1.1015, each cabin crew member undergoes a check covering the training received in order to verify his proficiency in carrying out normal and emergency safety duties. At the discretion of the Authority, the operator or the approved training organisation providing the training course shall ensure that the personnel performing these checks shall be suitably qualified.
- (b) The operator shall ensure that each cabin crew member undergoes checks as follows:
- (1) *Initial training.* The items listed in Appendix 1 to OPS 1.1005;
 - (2) *Conversion and Differences training.* The items listed in Appendix 1 to OPS 1.1010;
 - (3) *Recurrent training.* The items listed in Appendix 1 to OPS 1.1015 as appropriate; and
 - (4) *Refresher training.* The items listed in Appendix 1 to OPS 1.1020.

OPS 1.1030 Operation on More than One Type or Variant

(See AC OPS 1.1030)

- (a) The operator shall ensure that each cabin crew member does not operate on more than three aeroplane types except that, with the approval of the Authority, the cabin crew member may operate on four aeroplane types, provided that for at least two of the types:
- (1) non-type-specific normal and emergency procedures are identical; and



- (2) safety equipment and type-specific normal and emergency procedures are similar.
- (b) For the purposes of sub-paragraph (a) above, variants of an aeroplane type are considered to be different types if they are not similar in each of the following aspects:
- (1) emergency exit operation;
 - (2) location and type of portable safety equipment; and
 - (3) type-specific emergency procedures.

OPS 1.1035 Training Records

(See AMC OPS 1.1035)

- (a) The operator shall:
- (1) Maintain records of all training and checking required by OPS 1.1005, OPS 1.1010, OPS 1.1015, OPS 1.1020 and OPS 1.1025; and
 - (2) keep a copy of the attestation of safety training; and
 - (3) keep the training records and records of medical examinations or assessments up to date, showing in the case of the training records the dates and contents of the conversion, differences and recurrent training received; and
 - (4) Make the records of all initial, conversion and recurrent training and checking available, on request, to the cabin crew member concerned.

**Appendix 1 to OPS 1.1005****Initial Safety Training**

(See Appendix 3 to OPS 1.1005/1.1010/1.1015)

(See AMC to Appendix 1 to OPS 1.1005/1.1010/1.1015/1.1020)

The subjects that must be covered as a minimum by a course of initial safety training referred to in OPS 1.1005 are:

- (a) *Fire and Smoke Training.* the operator shall ensure that fire and smoke training includes:
- (1) Emphasis on the responsibility of cabin crew to deal promptly with emergencies involving fire and smoke and, in particular, emphasis on the importance of identifying the actual source of the fire;
 - (2) The importance of informing the flight crew immediately, as well as the specific actions necessary for co-ordination and assistance, when fire or smoke is discovered;
 - (3) The necessity for frequent checking of potential fire-risk areas including toilets, and the associated smoke detectors;
 - (4) The classification of fires and the appropriate type of extinguishing agents and procedures for particular fire situations, the techniques of application of extinguishing agents, the consequences of misapplication, and of use in a confined space; and
 - (5) The general procedures of ground-based emergency services at aerodromes.

- (b) *Water Survival Training.*

The actual donning and use of personal flotation equipment in water. Before first operating on an aeroplane fitted with life-rafts or other similar equipment, training must be given on the use of this equipment, as well as actual practice in water.

- (c) *Survival Training.*

Survival training shall be appropriate to the areas of operation, (e.g. polar, desert, jungle or sea).

- (d) *Medical aspects and First Aid.*

- (1) Instruction on medical aspects and first aid, first-aid kits, emergency medical kits, their contents and emergency medical equipment;
- (2) First aid associated with survival training and appropriate hygiene; and
- (3) The physiological effects of flying and with particular emphasis on hypoxia.

- (e) *Passenger handling.*

- (1) Advice on the recognition and management of passengers who are, or become, intoxicated with alcohol or are under the influence of drugs or are aggressive;
- (2) Methods used to motivate passengers and the crowd control necessary to expedite an aeroplane evacuation;



- (3) Regulations covering the safe stowage of cabin baggage (including cabin service items) and the risk of it becoming a hazard to occupants of the cabin or otherwise obstructing or damaging safety equipment or aeroplane exits;
- (4) The importance of correct seat allocation with reference to aeroplane mass and balance. Particular emphasis shall also be given on the seating of disabled passengers, and the necessity of seating able-bodied passengers adjacent to unsupervised exits;
- (5) Duties to be undertaken in the event of encountering turbulence including securing the cabin;
- (6) Precautions to be taken when live animals are carried in the cabin;
- (7) Dangerous Goods training including provisions under Subpart R; and
- (8) Security procedures, including the provisions under Subpart S.

(f) *Communication.*

During training, emphasis is placed on the importance of effective communication between cabin crew and flight crew including technique, common language and terminology.

(g) *Discipline and responsibilities.*

- (1) The importance of cabin crew performing their duties in accordance with the Operations Manual;
- (2) Continuing competence and fitness to operate as a cabin crew member with special regard to flight and duty time limitations and rest requirements;
- (3) An awareness of the aviation regulations relating to cabin crew and the role of the Authority;
- (4) General knowledge of relevant aviation terminology, theory of flight, passenger distribution, meteorology and areas of operation;
- (5) Pre-flight briefing of the cabin crew and the provision of necessary safety information with regard to their specific duties;
- (6) The importance of ensuring that relevant documents and manuals are kept up-to-date with amendments provided by the operator;
- (7) The importance of identifying when cabin crew members have the authority and responsibility to initiate an evacuation and other emergency procedures;
- (8) The importance of safety duties and responsibilities and the need to respond promptly and effectively to emergency situations; and
- (9) Awareness of the effects of surface contamination and the need to inform the flight crew of any observed surface contamination.



(h) *Crew Resource Management.*

(1) Introductory CRM Course:

- (i) A cabin crew member shall complete an Introductory CRM Course before being first assigned to operate as a cabin crew member. Cabin crew who are already operating as cabin crew members in commercial air transportation and who have not previously completed an introductory course, shall complete an Introductory CRM Course by the time of the next required recurrent training and/or checking.
- (ii) The training elements in Appendix 2 to OPS 1.1005/1.1010/1.1015 Table 1, Column (a) shall be covered to the level required in Column (b), Introductory CRM Course.
- (iii) The Introductory CRM Course shall be conducted by at least one cabin crew CRM instructor.

**Appendix 1 to OPS 1.1010****Conversion and Differences Training**

(See AMC to Appendix 1 to OPS 1.1010/1.1015)

(See AMC to Appendix 1 to OPS 1.1005/1.1010/1.1015/1.1020)

(See Appendix 3 to OPS 1.1005/1.1010/1.1015)

(a) *General.*

The operator shall ensure that:

- (1) conversion and differences training is conducted by suitably qualified persons; and
- (2) during conversion and differences training, training is given on the location, removal and use of all safety and survival equipment carried on the aeroplane, as well as all normal and emergency procedures related to the aeroplane type, variant and configuration to be operated.

(b) *Fire and smoke training.*

The operator shall ensure that:

- (1) each cabin crew member is given realistic and practical training in the use of all fire fighting equipment including protective clothing representative of that carried in the aeroplane. This training must include:
 - (i) extinguishing a fire characteristic of an aeroplane interior fire except that, in the case of Halon extinguishers, an alternative extinguishing agent may be used; and
 - (ii) the donning and use of protective breathing equipment in an enclosed, simulated smoke-filled environment.

(c) *Operation of doors and exits.*

The operator shall ensure that:

- (1) each cabin crew member operates and actually opens each type or variant of normal and emergency exits in the normal and emergency modes, including failure of power assist systems where fitted. This is to include the action and forces required to operate and deploy evacuation slides. This training shall be conducted in an aeroplane or representative training device; and
- (2) the operation of all other exits, such as flight deck windows is demonstrated.

(d) *Evacuation slide training.*

The operator shall ensure that:

- (1) each cabin crew member descends an evacuation slide from a height representative of the aeroplane main deck sill height;
- (2) the slide is fitted to an aeroplane or a representative training device



- (3) a further descent is made when the cabin crew member qualifies on an aeroplane type in which the main deck exit sill height differs significantly from any aeroplane type previously operated.

(e) *Evacuation procedures and other emergency situations.*

The operator shall ensure that:

- (1) emergency evacuation training includes the recognition of planned or unplanned evacuations on land or water. This training must include recognition of when exits are unusable or when evacuation equipment is unserviceable; and
- (2) each cabin crew member is trained to deal with the following:
 - (i) an in-flight fire, with particular emphasis on identifying the actual source of the fire;
 - (ii) severe air turbulence;
 - (iii) sudden decompression, including the donning of portable oxygen equipment by each cabin crew member; and
 - (iv) other in-flight emergencies.

(f) *Crowd control.*

The operator shall ensure that training is provided on the practical aspects of crowd control in various emergency situations, as applicable to the aeroplane type.

(g) *Pilot incapacitation.*

The operator shall ensure that, unless the minimum flight crew is more than two, each cabin crew member is trained in the procedure for flight crew member incapacitation and shall operate the seat and harness mechanisms. Training in the use of flight crew members' oxygen system and use of the flight crew members' check lists, where required by the operator's SOP's, shall be conducted by a practical demonstration.

(h) *Safety equipment.*

The operator shall ensure that each cabin crew member is given realistic training on, and demonstration of, the location and use of safety equipment including the following:

- (1) Slides, and where non self-supporting slides are carried, the use of any associated ropes;
- (2) Life-rafts and slide-rafts, including the equipment attached to, and/or carried in, the raft;
- (3) Lifejackets, infant lifejackets and flotation cots;
- (4) Dropout oxygen system;
- (5) First-aid oxygen;
- (6) Fire extinguishers;



- (7) Fire axe or crow-bar;
- (8) Emergency lights including torches;
- (9) Communications equipment, including megaphones;
- (10) Survival packs, including their contents;
- (11) Pyrotechnics (actual or representative devices);
- (12) First-aid kits, emergency medical kits, their contents and emergency medical equipment;
and
- (13) Other cabin safety equipment or systems where applicable.

(i) *Passenger Briefing/Safety Demonstrations.*

The operator shall ensure that training is given in the preparation of passengers for normal and emergency situations in accordance with OPS 1.285.

- (j) When initial medical aspects and first aid training has not included the avoidance of infectious diseases, especially in tropical and sub-tropical climates, such training shall be provided if the operator's route network is extended or changed to include such areas.
- (k) Crew Resource Management.

The operator shall ensure that:

- (1) Each cabin crew member completes the Operator's CRM Training covering the training elements in Appendix 2 to OPS 1.1005/1.1010/1.1015 Table 1, Column (a) to the level required in Column (c) before undertaking subsequent aeroplane type-specific CRM and/or recurrent CRM Training.
- (2) When a cabin crew member undertakes a conversion course on another aeroplane type, the training elements in Appendix 2 to OPS 1.1005/1.1010/1.1015 Table 1, Column (a) shall be covered to the level required in Column (d), aeroplane type-specific CRM.
- (3) The Operator's CRM Training and aeroplane type-specific CRM shall be conducted by a least one cabin crew CRM instructor.

**Appendix 1 to OPS 1.1015****Recurrent Training**

(See AMC to Appendix 1 to OPS 1.1010/1.1015)

(See Appendix 3 to OPS 1.1005/1.1010/1.1015)

(See AMC to Appendix 1 to OPS 1.1005/1.1010/1.1015/1.1020)

- (a) The operator shall ensure that recurrent training is conducted by suitably qualified persons.
- (b) The operator shall ensure that every 12 calendar months the programme of practical training includes the following:
 - (1) Emergency procedures including pilot incapacitation;
 - (2) Evacuation procedures including crowd control techniques;
 - (3) Touch-drills by each cabin crew member for opening normal and emergency exits for passenger evacuation;
 - (4) The location and handling of emergency equipment, including oxygen systems, and the donning by each cabin crew member of lifejackets, portable oxygen and protective breathing equipment (PBE);
 - (5) Medical aspects and first aid, first-aid kits, emergency medical kits, their contents and emergency medical equipment;
 - (6) Stowage of articles in the cabin;
 - (7) Security procedures;
 - (8) Incident and accident review;
 - (9) Awareness of the effects of surface contamination and the need to inform the flight crew of any observed surface contamination, and
 - (10) Crew Resource Management. the operator shall ensure that CRM training satisfies the following:
 - (i) The training elements in Appendix 2 to OPS 1.1005/1.1010/1.1015 Table 1, Column (a) shall be covered within a three year cycle to the level required by Column (e), Annual Recurrent CRM Training.
 - (ii) The definition and implementation of this syllabus shall be managed by a cabin crew CRM instructor.
 - (iii) When CRM training is provided by stand-alone modules, it shall be conducted by at least one cabin crew CRM instructor.
- (c) The operator shall ensure that, at intervals not exceeding 3 years, recurrent training also includes:
 - (1) Each cabin crew member operating and actually opening each type or variant of normal and emergency exit in the normal and emergency modes, including failure of power assist systems where fitted. This is to include the action and forces required to operate and



deploy evacuation slides. This training shall be conducted in an aeroplane or representative training device;

- (2) Demonstration of the operation of all other exits including flight deck windows;
 - (3) Each cabin crew member being given realistic and practical training in the use of all fire-fighting equipment, including protective clothing, representative of that carried in the aeroplane. This training must include:
 - (i) each cabin crew member extinguishing a fire characteristic of an aeroplane interior fire except that, in the case of Halon extinguishers, an alternative extinguishing agent may be used; and
 - (ii) the donning and use of protective breathing equipment by each cabin crew member in an enclosed, simulated smoke-filled environment.
 - (4) Use of pyrotechnics (actual or representative devices); and
 - (5) Demonstration of the use of the life-raft, or slide-raft, where fitted.
 - (6) The operator shall ensure that, unless the minimum flight crew is more than two, each cabin crew member is trained in the procedure for flight crew member incapacitation and shall operate the flight crew members' seat and harness mechanisms. Training in the use of the flight crew members' oxygen system and use of flight crew member's check lists, where required by the operator's SOP's, shall be conducted by a practical demonstration.
- (d) The operator shall ensure that all appropriate OPS 1 requirements are included in the training of cabin crew members.



Appendix 1 to OPS 1.1020

Refresher Training

The operator shall ensure that refresher training is conducted by suitable qualified persons and, for each cabin crew member, includes at least the following:

- (a) emergency procedures including pilot incapacitation;
- (b) evacuation procedures including crowd control techniques;
- (c) the operation and actual opening of each type or variant of normal and emergency exit in the normal and emergency modes, including failure of power assist systems where fitted. This is to include the action and forces required to operate and deploy evacuation slides. This training shall be conducted in an aeroplane or representative training device;
- (d) demonstration of the operation of all other exits including flight deck windows; and
- (e) the location and handling of emergency equipment, including oxygen systems, and the donning of lifejackets, portable oxygen and protective breathing equipment.



Appendix 2 to OPS 1.1005/1.1010/1.1015

Training

(See AC OPS 1.1005/1.1010/1.1015)

- (a) The CRM training syllabi, together with CRM methodology and terminology, shall be included in the Operations Manual.
- (b) The following table indicates which elements of CRM shall be included in each type of training.

Training Elements (a)	Introductory CRM Course (b)	Operator's CRM Training (c)	Aeroplane Type-Specific CRM (d)	Annual Recurrent CRM Training (e)	Senior Cabin Crew Course (f)
General Principles					
Human factors in aviation General instructions on CRM principles and objectives	In depth	Not required	Not required	Not required	Overview
Human performance and limitations					
From the perspective of the individual cabin crew member					
Personality awareness, human error and reliability, attitudes and behaviours, self-assessment	In depth	Not required	Not required	Overview (3 year cycle)	Not required
Stress and stress management					
Fatigue and vigilance					
Assertiveness					
Situation awareness, information acquisition and processing					
From the perspective of the whole aeroplane crew					
Error prevention and detection	Not required	In depth	Relevant to the type(s)	Overview (3 year cycle)	Reinforcement (relevant to the Senior cabin crew duties)
Shared situation awareness, information acquisition & processing					
Workload management					
Effective communication and coordination between all crew members including the flight crew as well as inexperienced cabin crew members, cultural differences					
Leadership, co-operation, synergy, decision-making, delegation					
Individual and team responsibilities, decision making, and actions					
Identification and management of the passenger human factors : crowd control, passenger stress, conflict management, medical factors					
Specifics related to aeroplane types (narrow / wide bodies, single / multi deck) flight crew and cabin crew composition and number of passengers		Not required	In depth		
From the perspective of the operator and the organisation					
Company safety culture, SOPs, organisational factors, factors linked to the type of operations	Not required	In depth	Relevant to the type(s)	Overview (3 year cycle)	Reinforcement (relevant to the Senior cabin crew duties)
Effective communication and coordination with other operational personnel and ground services					
Participation in cabin safety incident and accident reporting					
Case-based studies (see note)		Required	Required		

Note: In Column (d), if relevant aeroplane type-specific case based studies are not available, then case based studies relevant to the scale and scope of the operation shall be considered

**Appendix 3 to OPS 1.1005/1.1010/1.1015****Medical Aspects and First Aid Training**

(See Appendix 1 to OPS 1.1005)

(See Appendix 1 to OPS 1.1010)

(See Appendix 1 to OPS 1.1015)

- (a) Medical aspects and first aid training shall include the following subjects:
- (1) Physiology of flight including oxygen requirements and hypoxia;
 - (2) Medical emergencies in aviation including:
 - (i) Asthma;
 - (ii) Choking;
 - (iii) Heart attacks;
 - (iv) Stress reactions and allergic reactions;
 - (v) Shock;
 - (vi) Stroke;
 - (vii) Epilepsy;
 - (vii) Diabetes;
 - (ix) Air sickness;
 - (x) Hyperventilation;
 - (xi) Gastro-intestinal disturbances; and
 - (xii) Emergency childbirth;
 - (3) Practical cardio-pulmonary resuscitation by each cabin crew member having regard to the aeroplane environment and using a specifically designed dummy;
 - (4) Basic first aid and survival training including care of:
 - (i) the unconscious;
 - (ii) burns;
 - (iii) wounds; and
 - (iv) fractures and soft tissue injuries;
 - (5) Travel health and hygiene including:
 - (i) the risk of contact with infectious diseases especially when operating into tropical and sub-tropical areas. Reporting of infectious diseases, protection from infection



and avoidance of water-borne and food-borne illness. Training shall include the means to reduce such risks;

- (ii) hygiene on board;
 - (iii) death on board;
 - (iv) handling of clinical waste;
 - (v) aircraft disinfection; and
 - (vi) alertness management, physiological effects of fatigue, sleep physiology, circadian rhythm and time zone changes;
- (6) The use of appropriate aeroplane equipment including first aid kits, emergency medical kits, first aid oxygen and emergency medical equipment.

**SUBPART P****MANUALS, LOGS AND RECORDS****OPS 1.1040 General Rules for Operations Manuals**

- (a) The operator shall ensure that the Operations Manual contains all instructions and information necessary for operations personnel to perform their duties.
- (b) The operator shall ensure that the contents of the Operations Manual, including all amendments or revisions, do not contravene the conditions contained in the Air Operator Certificate (AOC) or any applicable regulations and are acceptable to, or, where applicable, approved by, the Authority. (See AMC OPS 1.1040(b).)
- (c) Unless otherwise approved by the Authority, the operator must prepare the Operations Manual in the English language. In addition, the operator may translate and use that manual, or parts thereof, into another language. (See AMC OPS 1.1040(c).)
- (d) Should it become necessary for the operator to produce new Operations Manuals or major parts/volumes thereof, he/she must comply with sub-paragraph (c) above.
- (e) The operator may issue an Operations Manual in separate volumes.
- (f) The operator shall ensure that all operations personnel have easy access to a copy of each part of the Operations Manual which is relevant to their duties. In addition, the operator shall supply crew members with a personal copy of, or sections from Parts A and B of the Operations Manual, that are relevant for personal study.
- (g) The operator shall ensure that the Operations Manual is amended or revised so that the instructions and information contained therein are kept up to date. the operator shall ensure that all operations personnel are made aware of such changes that are relevant to their duties.
- (h) Each holder of an Operations Manual, or appropriate parts of it, shall keep it up to date with the amendments or revisions supplied by the operator.
- (i) The operator shall supply the Authority with intended amendments and revisions in advance of the effective date. When the amendment concerns any part of the Operations Manual which must be approved in accordance with OPS 1, this approval shall be obtained before the amendment becomes effective. When immediate amendments or revisions are required in the interest of safety, they may be published and applied immediately, provided that any approval required has been applied for.
- (j) The operator shall incorporate all amendments and revisions required by the Authority.
- (k) The operator must ensure that information taken from approved documents, and any amendment of such approved documentation, is correctly reflected in the Operations Manual and that the Operations Manual contains no information contrary to any approved documentation. However, this requirement does not prevent the operator from using more conservative data and procedures.
- (l) The operator must ensure that the contents of the Operations Manual are presented in a form in which they can be used without difficulty. The design of the Operations Manual shall observe Human Factors principles.



- (m) The operator may be permitted by the Authority to present the Operations Manual or parts thereof in a form other than on printed paper. In such cases, an acceptable level of accessibility, usability and reliability must be assured.
- (n) The use of an abridged form of the Operations Manual does not exempt the operator from the requirements of OPS 1.130.

OPS 1.1045 Operations Manual – Structure and Contents

(See Appendix 1 to OPS 1.1045)

(See AMC OPS 1.1045)

- (a) The operator shall ensure that the main structure of the Operations Manual is as follows:

Part A. General/Basic

This part shall comprise all non-type-related operational policies, instructions and procedures needed for a safe operation.

Part B. Aeroplane Operating Matters

This part shall comprise all type-related instructions and procedures needed for a safe operation. It shall take account of any differences between types, variants or individual aeroplanes used by the operator.

Part C. Route and Aerodrome Instructions and Information

This part shall comprise all instructions and information needed for the area of operation.

Part D. Training

This part shall comprise all training instructions for personnel required for a safe operation.

- (b) The operator shall ensure that the contents of the Operations Manual are in accordance with Appendix 1 to OPS 1.1045 and relevant to the area and type of operation.
- (c) The operator shall ensure that the detailed structure of the Operations Manual is acceptable to the Authority. (See AMC OPS 1.1045(c).)

OPS 1.1050 Aeroplane Flight Manual

- (a) The operator shall keep a current approved Aeroplane Flight Manual or equivalent document for each aeroplane that it operates.
- (b) The flight manual shall be updated by implementing changes made mandatory by the Authority, as State of Registry.

OPS 1.1055 Journey Log

- (a) The operator shall retain the following information for each flight in the form of a Journey Log:
 - (1) Aeroplane registration;



- (2) Date;
 - (3) Name(s) of crew member(s);
 - (4) Duty assignment of crew member(s);
 - (5) Place of departure;
 - (6) Place of arrival;
 - (7) Time of departure (off-block time);
 - (8) Time of arrival (on-block time);
 - (9) Hours of flight;
 - (10) Nature of flight;
 - (11) Incidents, observations (if any); and
 - (12) Commander's signature (or equivalent). (See AMC OPS 1.1055 (a)(12).)
- (b) The operator may be permitted not to keep an aeroplane Journey Log, or parts thereof, by the Authority if the relevant information is available in other documentation. (See AMC OPS 1.1055(b).)
- (c) The operator shall ensure that all entries are made concurrently and that they are permanent in nature.

OPS 1.1060 Operational Flight Plan

- (a) The operator must ensure that the operational flight plan used and the entries made during flight contain the following items:
- (1) Aeroplane registration;
 - (2) Aeroplane type and variant;
 - (3) Date of flight;
 - (4) Flight identification;
 - (5) Names of flight crew members;
 - (6) Duty assignment of flight crew members;
 - (7) Place of departure;
 - (8) Time of departure (actual off-block time, take-off time);
 - (9) Place of arrival (planned and actual);
 - (10) Time of arrival (actual landing and on-block time);



- (11) Type of operation (EDTO, VFR, Ferry flight, etc.);
 - (12) Route and route segments with checkpoints/waypoints, distances, time and tracks;
 - (13) Planned cruising speed and flying times between check-points/waypoints. Estimated and actual times overhead;
 - (14) Safe altitudes and minimum levels;
 - (15) Planned altitudes and flight levels;
 - (16) Fuel calculations (records of in-flight fuel checks);
 - (17) Fuel on board when starting engines;
 - (18) Alternate(s) for destination and, where applicable, take-off and en-route, including information required in sub-paragraphs (12), (13), (14), and (15) above;
 - (19) Initial ATS Flight Plan clearance and subsequent re-clearance;
 - (20) In-flight re-planning calculations; and
 - (21) Relevant meteorological information.
- (b) Items which are readily available in other documentation or from another acceptable source or are irrelevant to the type of operation may be omitted from the operational flight plan.
- (c) The operator must ensure that the operational flight plan and its use are described in the Operations Manual.
- (d) The operator shall ensure that all entries on the operational flight plan are made concurrently and that they are permanent in nature.
- (e) The operational flight plan shall be completed for every intended flight and shall be approved by the commander, and where applicable, by the flight operations officer/flight dispatcher.
- (f) The operator shall determine the most efficient means of lodging the operational flight plan to the appropriate Air Traffic Services.

OPS 1.1065 Document Storage Periods

The operator shall ensure that all records and all relevant operational and technical information for each individual flight, are stored for the periods prescribed in Appendix 1 to OPS 1.1065.

OPS 1.1070 Operator's Maintenance Management Exposition

The operator shall keep a current approved maintenance management exposition in accordance with Subpart M.

OPS 1.1071 Aeroplane Technical Log

The operator shall keep an Aeroplane Technical Log.



Appendix 1 to OPS 1.1045 Operations Manual Contents

(See AMC to Appendix 1 to OPS 1.1045)

The operator shall ensure that the Operations Manual contains the following:

A. GENERAL/BASIC

0 ADMINISTRATION AND CONTROL OF OPERATIONS MANUAL

0.1 Introduction

- (a) A statement that the manual complies with all applicable regulations and with the terms and conditions of the applicable Air operator certificate.
- (b) A statement that the manual contains operational instructions that are to be complied with by the relevant personnel.
- (c) A list and brief description of the various parts, their contents, applicability and use.
- (d) Explanations and definitions of terms and words needed for the use of the manual.

0.2 System of amendment and revision

- (a) Details of the person(s) responsible for the issuance and insertion of amendments and revisions.
- (b) A record of amendments and revisions with insertion dates and effective dates.
- (c) A statement that handwritten amendments and revisions are not permitted except in situations requiring immediate amendment or revision in the interest of safety.
- (d) A description of the system for the annotation of pages and their effective dates.
- (e) A list of effective pages.
- (f) Annotation of changes (on text pages and, as far as practicable, on charts and diagrams).
- (g) Temporary revisions.
- (h) A description of the distribution system for the manuals, amendments and revisions.

1 ORGANISATION AND RESPONSIBILITIES

1.1 *Organisational structure.* A description of the organisational structure including the general company organigram and operations department organigram. The organigram must depict the relationship between the Operations Department and the other Departments of the company. In particular, the subordination and reporting lines of all Divisions, Departments etc., which pertain to the safety of flight operations, must be shown.

1.2 *Nominated postholders.* The name of each nominated postholder responsible for flight operations, continuing airworthiness, crew training and ground operations, as prescribed in OPS 1.175(i). A description of their function and responsibilities must be included.



- 1.3 *Responsibilities and duties of operations management personnel.* A description of the duties, responsibilities and authority of operations management personnel pertaining to the safety of flight operations and the compliance with the applicable regulations.
- 1.4 *Authority, duties and responsibilities of the commander.* A statement defining the authority, duties and responsibilities of the commander.
- 1.5 *Duties and responsibilities of crew members other than the commander.*

2 OPERATIONAL CONTROL AND SUPERVISION

- 2.1 *Supervision of the operation by the operator.* A description of the system for supervision of the operation by the operator (See OPS 1.175(g)). This must show how the safety of flight operations and the qualifications of personnel are supervised. In particular, the procedures related to the following items must be described:
 - (a) Licence and qualification validity;
 - (b) Competence of operations personnel; and
 - (c) Control, analysis and storage of records, flight documents, additional information and data.
- 2.2 *System of promulgation of additional operational instructions and information.* A description of any system for promulgating information which may be of an operational nature but is supplementary to that in the Operations Manual. The applicability of this information and the responsibilities for its promulgation must be included.
- 2.3 *Operational control.* A description of the procedures and responsibilities necessary to exercise operational control with respect to flight safety.
- 2.4 *Powers of the Authority.* A description of the powers of the Authority and guidance to staff on how to facilitate inspections by Authority personnel.

3 MANAGEMENT SYSTEM

A description of the quality system including at least the following:

- (a) Quality policy;
- (b) A description of the organisation of the quality system;
- (c) Allocation of duties and responsibilities;

4 CREW COMPOSITION

- 4.1 *Crew Composition.* An explanation of the method for determining crew compositions taking account of the following:
 - (a) The type of aeroplane being used;
 - (b) The area and type of operation being undertaken;



- (c) The phase of the flight;
- (d) The minimum crew requirement and flight duty period planned;
- (e) Experience (total and on type), recency and qualification of the crew members; and
- (f) The designation of the commander and, if necessitated by the duration of the flight, the procedures for the relief of the commander or other members of the flight crew. (See Appendix 1 to OPS 1.940.)
- (g) The designation of the senior cabin crew member and, if necessitated by the duration of the flight, the procedures for the relief of the senior cabin crew member and any other member of the cabin crew.

- 4.2 *Designation of the commander.* The rules applicable to the designation of the commander.
- 4.3 *Flight crew incapacitation.* Instructions on the succession of command in the event of flight crew incapacitation.
- 4.4 *Operation on more than one type.* A statement indicating which aeroplanes are considered as one type for the purpose of:
- (a) Flight crew scheduling; and
 - (b) Cabin crew scheduling.

5 QUALIFICATION REQUIREMENTS

- 5.1 A description of the required licence, rating(s), qualification/competency (e.g. for routes and aerodromes), experience, training, checking and recency for operations personnel to conduct their duties. Consideration must be given to the aeroplane type, kind of operation and composition of the crew.
- 5.2 *Flight crew*
- (a) Commander.
 - (b) Pilot relieving the commander.
 - (c) Co-pilot.
 - (d) Pilot under supervision.
 - (e) System panel operator.
 - (f) Operation on more than one type or variant.
- 5.3 *Cabin crew.*
- (a) Senior cabin crew member.
 - (b) Cabin crew member.



- (1) Required cabin crew member.
 - (2) Additional cabin crew member and cabin crew member during familiarisation flights.
- (c) Operation on more than one type or variant.

5.4 *Training, checking and supervision personnel.*

- (a) For flight crew.
- (b) For cabin crew.

5.5 *Other operations personnel* (including technical crew and crew members other than flight, cabin and technical crew).

6 CREW HEALTH PRECAUTIONS

6.1 *Crew health precautions.* The relevant regulations and guidance to crew members concerning health including:

- (a) Alcohol and other intoxicating liquor;
- (b) Narcotics;
- (c) Drugs;
- (d) Sleeping tablets;
- (e) Pharmaceutical preparations;
- (f) Immunisation;
- (g) Deep diving;
- (h) Blood donation;
- (i) Meal precautions prior to and during flight;
- (j) Sleep and rest; and
- (k) Surgical operations.

7 FLIGHT TIME LIMITATIONS

7.1 *Flight and Duty Time Limitations and Rest Requirements.* The scheme developed by the operator in accordance with Subpart Q.

7.2 *Exceedances of flight and duty time limitations and/or reductions of rest periods.* Conditions under which flight and duty time may be exceeded or rest periods may be reduced and the procedures used to report these modifications.

7.3 Information and policy relating to fatigue management including:



- (a) rules pertaining to flight time, flight duty period, duty period-limitations and rest requirements for flight and cabin crew members; and
- (b) policy and documentation pertaining to the operator's Fatigue Risk Management System (FRMS).

8 OPERATING PROCEDURES

8.1 *Flight Preparation Instructions.* As applicable to the operation:

8.1.1 *Minimum Flight Altitudes.* A description of the method of determination and application of minimum altitudes including:

- (a) A procedure to establish the minimum altitudes/flight levels for VFR flights; and
- (b) A procedure to establish the minimum altitudes/flight levels for IFR flights.

8.1.2 *Criteria and responsibilities for the authorisation of the use of aerodromes taking into account the applicable requirements of Subparts D, E, F, G, H, I and J.*

8.1.3 *Methods for establishing aerodrome operating minima.* The method for establishing aerodrome operating minima for IFR flights in accordance with OPS 1 Subpart E. Reference must be made to procedures for the determination of the visibility and/or runway visual range and for the applicability of the actual visibility observed by the pilots, the reported visibility and the reported runway visual range.

8.1.4 *En-route Operating Minima for VFR Flights or VFR portions of a flight and, where Single-engine aeroplanes are used, instructions for route selection with respect to the availability of surfaces which permit a safe forced landing.*

8.1.5 *Presentation and Application of Aerodrome and En-route Operating Minima*

8.1.6 *Interpretation of meteorological information.* Explanatory material on the decoding of MET forecasts and MET reports relevant to the area of operations, including the interpretation of conditional expressions.

8.1.7 *Determination of the quantities of fuel, oil and water methanol carried.* The methods by which the quantities of fuel, oil and water methanol, as applicable, to be carried are determined and monitored in flight. This section must also include instructions on the measurement and distribution of the fluid carried on board. Such instructions must take account of all circumstances likely to be encountered on the flight, including the possibility of in-flight replanning and of failure of one or more of the aeroplane's power plants. The system for maintaining fuel and oil records must also be described.

8.1.8 *Mass and Centre of Gravity.* The general principles of mass and centre of gravity including:

- (a) Definitions;
- (b) Methods, procedures and responsibilities for preparation and acceptance of mass and centre of gravity calculations;
- (c) The policy for using standard and/or actual masses;



- (d) The method for determining the applicable passenger, baggage and cargo mass;
- (e) The applicable passenger and baggage masses for various types of operations and aeroplane type;
- (f) General instruction and information necessary for verification of the various types of mass and balance documentation in use;
- (g) Last Minute Changes procedures;
- (h) Specific gravity of fuel, oil and water methanol; and
- (i) Seating policy/procedures.

8.1.9 *ATS Flight Plan*. Procedures and responsibilities for the preparation and submission of the air traffic services flight plan. Factors to be considered include the means of submission for both individual and repetitive flight plans.

8.1.10 *Operational Flight Plan*. Procedures and responsibilities for the preparation and acceptance of the operational flight plan. The use of the operational flight plan must be described including samples of the operational flight plan formats in use.

8.1.11 *Operator's Aeroplane Technical Log*. The responsibilities and the use of the operator's Aeroplane Technical Log must be described, including samples of the format used.

8.1.12 *List of documents, forms and additional information to be carried*.

8.2 *Ground Handling Instructions*

Note: This section should also contain subcontracting policies; handling processes; and procedures and practices for all ground handling operations.

8.2.1 *Fuelling procedures*. A description of fuelling procedures, including:

- (a) Safety precautions during refuelling and defueling including when an APU is in operation or when a turbine engine is running and the prop-brakes are on;
- (b) Refuelling and defueling when passengers are embarking, on board or disembarking; and
- (c) Precautions to be taken to avoid mixing fuels.

8.2.2 *Aeroplane, passengers and cargo handling procedures related to safety*. A description of the handling procedures to be used when allocating seats and embarking and disembarking passengers and when loading and unloading the aeroplane. Further procedures, aimed at achieving safety whilst the aeroplane is on the ramp, must also be given. Handling procedures must include:

- (a) Children/infants, sick passengers and Persons with Reduced Mobility;
- (b) Transportation of inadmissible passengers, deportees or persons in custody;
- (c) Permissible size and weight of hand baggage;



- (d) Loading and securing of items in the aeroplane;
- (e) Special loads and classification of load compartments;
- (f) Positioning of ground equipment;
- (g) Operation of aeroplane doors;
- (h) Safety on the ramp, including fire prevention, blast and suction areas;
- (i) Start-up, ramp departure and arrival procedures including push-back and towing operations;
- (j) Servicing of aeroplanes;
- (k) Documents and forms for aeroplane handling; and
- (l) Multiple occupancy of aeroplane seats.

8.2.3 *Procedures for the refusal of embarkation.* Procedures to ensure that persons who appear to be intoxicated or who demonstrate by manner or physical indications that they are under the influence of drugs, are refused embarkation. This does not apply to medical patients under proper care.

8.2.4 *De-icing and Anti-icing on the ground.* A description of the de-icing and anti-icing policy and procedures for aeroplanes on the ground. These shall include descriptions of the types and effects of icing and other contaminants on aeroplanes whilst stationary, during ground movements and during take-off. In addition, a description of the fluid types used must be given including:

- (a) Proprietary or commercial names;
- (b) Characteristics;
- (c) Effects on aeroplane performance;
- (d) Hold-over times; and
- (e) Precautions during usage.

8.3 *Flight Procedures*

8.3.1 *VFR/IFR Policy.* A description of the policy for allowing flights to be made under VFR, or of requiring flights to be made under IFR, or of changing from one to the other.

8.3.2 *Navigation Procedures.* A description of all navigation procedures relevant to the type(s) and area(s) of operation. Consideration must be given to:

- (a) Standard navigational procedures including policy for carrying out independent cross-checks of keyboard entries where these affect the flight path to be followed by the aeroplane;
- (b) NAT HLA and POLAR navigation and navigation in other designated areas;



- (c) RNAV;
- (d) In-flight replanning;
- (e) Procedures in the event of system degradation; and
- (f) RVSM.

8.3.3 *Altimeter setting procedures including use, where appropriate, of*

- metric altimetry and conversion tables, and
- QFE operating procedures.

8.3.4 *Altitude alerting system procedures*

8.3.5 *Ground Proximity Warning System/ Terrain Avoidance Warning System.* Procedures and instructions required for the avoidance of controlled flight into terrain, including limitations on high rate of descent near the surface (the related training requirements are covered in D.2.1); including instructions on the clarification and acceptance of air traffic clearances particularly where a traffic conflict or terrain clearance is involved;

8.3.6 *Policy and procedures for the use of TCAS/ACAS*

8.3.7 *Policy and procedures for in-flight fuel management*

8.3.8 *Adverse and potentially hazardous atmospheric conditions.* Procedures for operating in, and/or avoiding, adverse and potentially hazardous atmospheric conditions including:

- (a) Thunderstorms;
- (b) Icing conditions;
- (c) Turbulence;
- (d) Windshear;
- (e) Jetstream;
- (f) Volcanic ash clouds;
- (g) Heavy precipitation;
- (h) Sand storms;
- (i) Mountain waves; and
- (j) Significant Temperature inversions.

8.3.9 *Wake Turbulence.* Wake turbulence separation criteria, taking into account aeroplane types, wind conditions and runway location.



- 8.3.10 *Crew members at their stations.* The requirements for crew members to occupy their assigned stations or seats during the different phases of flight or whenever deemed necessary in the interest of safety and also include procedures for controlled rest on the flight deck.
- 8.3.11 *Use of safety belts for crew and passengers.* The requirements for crew members and passengers to use safety belts and/or harnesses during the different phases of flight or whenever deemed necessary in the interest of safety.
- 8.3.12 *Admission to Flight Deck.* The conditions for the admission to the flight deck of persons other than the flight crew. The policy regarding the admission of Inspectors from the Authority must also be included.
- 8.3.13 *Use of vacant crew seats.* The conditions and procedures for the use of vacant crew seats.
- 8.3.14 *Incapacitation of crew members.* Procedures to be followed in the event of incapacitation of crew members in flight. Examples of the types of incapacitation and the means for recognising them must be included.
- 8.3.15 *Cabin Safety Requirements.* Procedures covering:
- (a) Cabin preparation for flight, in-flight requirements and preparation for landing including procedures for securing the cabin and galleys;
 - (b) Procedures to ensure that passengers are seated where, in the event that an emergency evacuation is required, they may best assist and not hinder evacuation from the aeroplane;
 - (c) Procedures to be followed during passenger embarkation and disembarkation; and
 - (d) Procedures when refuelling/defueling with passengers embarking, on board or disembarking.
 - (e) Smoking on board.
 - (f) covering the handling of suspected infectious diseases.
- 8.3.16 *Passenger briefing procedures.* The contents, means and timing of passenger briefing in accordance with OPS 1.285.
- 8.3.17 *Procedures for aeroplanes operated whenever required cosmic or solar radiation detection equipment is carried.* Procedures for the use of cosmic or solar radiation detection equipment and for recording its readings including actions to be taken in the event that limit values specified in the Operations Manual are exceeded.
- 8.3.18 *Policy on the use of Autopilot and Autothrottle.*
- 8.3.19 *Other Policy and Procedures.* The addition of policy and procedures for the following;
- (a) Implementation of Aeroplane Flight Manual changes made mandatory or approved by the Authority or State of Registry;
 - (b) Retention of Flight Recorder recording and flight recorders in safe custody pending disposition;



- (c) the avoidance of CFIT;
 - (d) the use of GPWS.
- 8.4 *AWO*. A description of the operational procedures associated with All Weather Operations. (See also OPS 1, Subparts D & E) including instructions and requirements for the use of automatic landing systems, a head-up display (HUD) or equivalent displays, EVS, SVS or CVS equipment, as applicable.
- 8.5 *EDTO*. A description of the EDTO operational procedures.
- 8.6 *Use of the Minimum Equipment and Configuration Deviation List(s)*
- 8.7 *Non revenue flights*. Procedures and limitations for:
- (a) non-commercial operations by AOC holders including a description of the differences to commercial operations.
 - (b) Training flights;
 - (c) Test flights;
 - (d) Delivery flights;
 - (e) Ferry flights;
 - (f) Demonstration flights; and
 - (g) Positioning flights, including the kind of persons who may be carried on such flights.
- 8.8 *Oxygen Requirements*
- 8.8.1 An explanation of the conditions under which oxygen must be provided and used.
- 8.8.2 The oxygen requirements specified for:
- (a) Flight crew;
 - (b) Cabin crew; and
 - (c) Passengers.

Note: EFB procedures may be included in Chapter 8.9 or OMB, as appropriate.

9 DANGEROUS GOODS AND WEAPONS

- 9.1 Information, instructions and general guidance on the transport of dangerous goods including:
- (a) Operator's policy on the transport of dangerous goods;
 - (b) Guidance on the requirements for acceptance, labelling, handling, stowage and segregation of dangerous goods;



- (c) Special notification requirements in the event of an accident or occurrence when dangerous goods are being carried;
- (d) Procedures for responding to emergency situations involving dangerous goods;
- (e) Duties of all personnel involved as per OPS 1.1215; and
- (f) Instructions on the carriage of the operator's employees on cargo aircraft when dangerous goods are being carried.

9.2 The conditions under which weapons, munitions of war and sporting weapons may be carried.

10 SECURITY

10.1 Security instructions, guidance procedures, and training which must include the authority and responsibilities of operations personnel. Policies and procedures for handling and reporting crime on board such as unlawful interference, sabotage, bomb threats, and hijacking must also be included.

10.2 A description of preventative security measures and training.

Note: Parts of the security instructions and guidance may be kept confidential.

11 HANDLING, NOTIFYING AND REPORTING OCCURRENCES

Procedures for the handling, notifying and reporting occurrences. This section must include:

- (a) Definition of occurrences and of the relevant responsibilities of all persons involved;
- (b) Illustrations of forms used for reporting all types of occurrences (or copies of the forms themselves), instructions on how they are to be completed, the addresses to which they should be sent and the time allowed for this to be done;
- (c) In the event of an accident, descriptions of which company departments, Authorities and other organisations that have to be notified, how this will be done and in what sequence;
- (d) Procedures for the recording and verbal notification to air traffic service units of incidents involving ACAS RAs, bird hazards, and hazardous conditions including volcanic activity;
- (e) Procedures for submitting written reports on air traffic incidents, ACAS RAs, bird strikes, dangerous goods incidents or accidents, and unlawful interference;
- (f) Reporting procedures to ensure compliance with OPS 1.085(b) and OPS 1.420. These procedures must include internal safety-related reporting procedures to be followed by crew members, designed to ensure that the commander is informed immediately of any incident that has endangered, or may have endangered, safety during flight and that he is provided with all relevant information.
- (g) Procedures for the preservation of recordings following a reportable event.



12 RULES OF THE AIR

Rules of the Air including:

- (a) Visual and instrument flight rules;
- (b) Territorial application of the Rules of the Air;
- (c) Communication procedures including COM-failure procedures;
- (d) Information and instructions relating to the interception of civil aeroplanes;
- (e) The circumstances in which a radio listening watch is to be maintained;
- (f) Signals;
- (g) Time system used in operation;
- (h) ATC clearances, adherence to flight plan and position reports;
- (i) Visual signals used to warn an unauthorised aeroplane flying in or about to enter a restricted, prohibited or danger area;
- (j) Procedures for pilots observing an accident or receiving a distress transmission;
- (k) The ground/air visual codes for use by survivors, description and use of signal aids; and
- (l) Distress and urgency signals.

13 LEASING

A description of the operational arrangements for leasing and code-share, associated procedures and management responsibilities.

B AEROPLANE OPERATING MATTERS – TYPE-RELATED

Note: The operator may elect to reference the publications that comprise OMB and those publications shall be carried on the aeroplane when operated.

Taking account of the differences between types, and variants of types, under the following headings:

0 GENERAL INFORMATION AND UNITS OF MEASUREMENT

0.1 General Information (e.g. aeroplane dimensions), including a description of the units of measurement used for the operation of the aeroplane type concerned and conversion tables.

1 LIMITATIONS

1.1 A description of the certified limitations and the applicable operational limitations including:

- (a) Certification status (e.g. FAR/EASA CS-23, CS-25, ICAO Annex 16 (CS-36 and CS-34 etc.);



- (b) Passenger seating configuration for each aeroplane type including a pictorial presentation;
- (c) Types of operation that are approved (e.g. VFR/IFR, CAT II/III, PBN, flights in known icing conditions etc.);
- (d) Crew composition;
- (e) Mass and centre of gravity;
- (f) Speed limitations;
- (g) Flight envelope(s);
- (h) Wind limits including operations on contaminated runways;
- (i) Performance limitations for applicable configurations;
- (j) Runway slope;
- (k) Limitations on wet or contaminated runways;
- (l) Airframe contamination; and
- (m) System limitations.

2 NORMAL PROCEDURES

2.1 The normal procedures and duties assigned to the crew, the appropriate check-lists, the system for use of the check-lists and a statement covering the necessary coordination procedures between flight and cabin crew. The Standard Operating Procedures for each of the following phases of flight and associated duties must be included:

- (a) Pre-flight;
- (b) Pre-departure;
- (c) Altimeter setting and checking;
- (d) Taxi, Take-off and Climb;
- (e) Noise abatement;
- (f) Cruise and descent;
- (g) Approach, Landing preparation and briefing;
- (h) VFR Approach;
- (i) Instrument approach;
- (j) Visual Approach and circling;



- (k) Missed Approach;
- (l) Normal Landing;
- (m) Post Landing; and
- (n) Operation on wet and contaminated runways.

3 ABNORMAL AND EMERGENCY PROCEDURES

3.1 The abnormal and emergency procedures and duties assigned to the crew, the appropriate check-lists, the system for use of the check-lists and a statement covering the necessary co-ordination procedures between flight and cabin crew. The Standard Operating Procedures (SOPs) for each of the following abnormal and emergency procedures and duties must be included:

- (a) Crew Incapacitation;
- (b) Fire and Smoke Drills;
- (c) Unpressurised and partially pressurised flight;
- (d) Exceeding structural limits such as overweight landing;
- (e) Exceeding cosmic radiation limits;
- (f) Lightning Strikes;
- (g) Distress Communications and alerting ATC to Emergencies;
- (h) Engine failure;
- (i) System failures;
- (j) Guidance for Diversion in case of Serious Technical Failure;
- (k) Ground Proximity Warning;
- (l) TCAS Warning;
- (m) Windshear;
- (n) Emergency Landing/Ditching; and
- (o) Departure Contingency Procedures

4 PERFORMANCE

4.0 Performance data must be provided in a form in which it can be used without difficulty.

4.1 *Performance data.* Performance material which provides the necessary data for compliance with the performance requirements prescribed in OPS 1 Subparts F, G, H and I must be included to allow the determination of:



- (a) Take-off climb limits – Mass, Altitude, Temperature;
- (b) Take-off field length (dry, wet, contaminated);
- (c) Net flight path data for obstacle clearance calculation or, where applicable, take-off flight path;

Note: The operator should issue operating instructions and provide information on aeroplane climb performance with all engines operating to enable the pilot-in-command to determine the climb gradient that can be achieved during the departure phase for the existing take-off conditions and intended take-off technique.

- (d) The gradient losses for banked climb outs;
- (e) En-route climb limits;
- (f) Approach climb limits;
- (g) Landing climb limits;
- (h) Landing field length (dry, wet, contaminated) including the effects of an in-flight failure of a system or device, if it affects the landing distance;
- (i) Brake energy limits; and
- (j) Speeds applicable for the various flight stages (also considering wet or contaminated runways).

4.1.1. *Supplementary data covering flights in icing conditions.* Any certificated performance related to an allowable configuration, or configuration deviation, such as anti-skid inoperative, must be included.

4.1.2. If performance Data, as required for the appropriate performance class, is not available in the approved AFM, then other data acceptable to the Authority must be included. Alternatively, the Operations Manual may contain cross-reference to the approved Data contained in the AFM where such Data is not likely to be used often or in an emergency.

4.2 *Additional Performance Data.* Additional performance data where applicable including:

- (a) All engine climb gradients;
- (b) Drift-down data;
- (c) Effect of de-icing/anti-icing fluids;
- (d) Flight with landing gear down;
- (e) For aeroplanes with 3 or more engines, one-engine-inoperative ferry flights; and
- (f) Flights conducted under the provisions of the CDL.



5 FLIGHT PLANNING

- 5.1 Data and instructions necessary for pre-flight and in-flight planning including factors such as speed schedules and power settings. Where applicable, procedures for engine(s)-out operations, EDTO (particularly the one-engine-inoperative cruise speed and maximum distance to an adequate aerodrome determined in accordance with OPS 1.245) and flights to isolated aerodromes must be included.
- 5.2 The method for calculating fuel needed for the various stages of flight, in accordance with OPS 1.255.

6 MASS AND BALANCE

Instructions and data for the calculation of the mass and balance including:

- (a) Calculation system (e.g. Index system);
- (b) Information and instructions for completion of mass and balance documentation, including manual and computer generated types;
- (c) Limiting masses and centre of gravity for the types, variants or individual aeroplanes used by the operator; and
- (d) Dry Operating mass and corresponding centre of gravity or index.

7 LOADING

Procedures and provisions for loading and securing the load in the aeroplane.

8 CONFIGURATION DEVIATION LIST

The Configuration Deviation List(s) (CDL), if provided by the manufacturer, taking account of the aeroplane types and variants operated including procedures to be followed when an aeroplane is being dispatched under the terms of its CDL.

9 MINIMUM EQUIPMENT LIST

The Minimum Equipment List (MEL) taking account of the aeroplane types and variants operated and the type(s)/area(s) of operation. The MEL must include the navigational equipment and take into account the required navigation performance for the route and area of operation.

10 SURVIVAL AND EMERGENCY EQUIPMENT INCLUDING OXYGEN

- 10.1 A list of the survival equipment to be carried for the routes to be flown and the procedures for checking the serviceability of this equipment prior to take-off. Instructions regarding the location, accessibility and use of survival and emergency equipment and its associated check list(s) must also be included.
- 10.2 The procedure for determining the amount of oxygen required and the quantity that is available. The flight profile, number of occupants and possible cabin decompression must be considered. The information provided must be in a form in which it can be used without difficulty.



11 EMERGENCY EVACUATION PROCEDURES

- 11.1 *Instructions for preparation for emergency evacuation including crew co-ordination and emergency station assignment.*
- 11.2 *Emergency evacuation procedures.* A description of the duties of all members of the crew for the rapid evacuation of an aeroplane and the handling of the passengers in the event of a forced landing, ditching or other emergency.

12 AEROPLANE SYSTEMS

A description of the aeroplane systems, related controls and indications and operating instructions. (See AMC to Appendix 1 to OPS 1.1045.)

C ROUTE AND AERODROME INSTRUCTIONS AND INFORMATION

- 1 Instructions and information relating to communications, navigation and aerodromes including minimum flight levels and altitudes for each route to be flown and operating minima for each aerodrome planned to be used, including:
- (a) Minimum flight level/altitude;
 - (b) Operating minima for departure, destination and alternate aerodromes, including determination of aerodrome operating minima for instrument approaches using eligible equipment for operational credit;
 - (c) Communication facilities and navigation aids;
 - (d) Runway data and aerodrome facilities;
 - (e) Approach, missed approach and departure procedures including noise abatement procedures;
 - (f) COM-failure procedures;
 - (g) Search and rescue facilities in the area over which the aeroplane is to be flown;
 - (h) A description of the aeronautical charts that must be carried on board in relation to the type of flight and the route to be flown, including the method to check their validity;
 - (i) Availability of aeronautical information and MET services;
 - (j) En-route COM/NAV procedures;
 - (k) Aerodrome categorisation for flight crew competence qualification (See AMC OPS 1.975); and
 - (l) Special aerodrome limitations (performance limitations and operating procedures etc.); and
 - (m) Recording and reporting by flight crew on routine meteorological observations during en-route and climb phases of the flight and special and other non-routine observations during any phase of flight.



Note: The procedures for making meteorological observations on board aircraft in flight and for recording and reporting them are contained in ICAO Annex 3, the PANS-ATM (Doc 4444) and the appropriate Regional Supplementary Procedures (Doc 7030).

- (n) Acceptable level of Rescue and Fire Fighting Service (RFFS) Category

D TRAINING

- 1 Training syllabi and checking programmes for all operations personnel assigned to operational duties in connection with the preparation and/or conduct of a flight as well as ground handling training requirements.
- 2 Training syllabi and checking programmes must include:
 - 2.1 *For flight crew.* All relevant items prescribed in Subparts E and N including training for the avoidance of CFIT and the use of ACAS and GPWS and for any special approval (EFB, PBN,AWO etc.);
 - 2.2 *For cabin crew.* All relevant items prescribed in Subpart O;
 - 2.3 *For operations personnel concerned, including crew members:*
 - (a) All relevant items prescribed in Subpart R (Transport of Dangerous Goods by Air); and
 - (b) All relevant items prescribed in Subpart S (Security).
 - 2.4 *For operations personnel other than crew members (e.g. dispatcher, handling personnel etc.).* All other relevant items prescribed in OPS 1 pertaining to their duties.
- 3 *Procedures*
 - 3.1 Procedures for training and checking.
 - 3.2 Procedures to be applied in the event that personnel do not achieve or maintain the required standards.
 - 3.3 Procedures to ensure that abnormal or emergency situations requiring the application of part or all of abnormal or emergency procedures and simulation of IMC by artificial means, are not simulated during commercial air transportation flights.
- 4 Description of documentation to be stored and storage periods. (See Appendix 1 to OPS 1.1065.)



Appendix 1 to OPS 1.1065 Document Storage Periods

The operator shall ensure that the following information/documentation is stored in an acceptable form, accessible to the Authority, for the periods shown in the Tables below.

Table 1 – Information used for the preparation and execution of a flight

Information used for the preparation and execution of the flight as described in OPS 1.135	
Operational flight plan	3 months
Aeroplane Technical Log	36 months after the date of the last entry.
Route specific NOTAM/AIS briefing documentation if edited by the operator	3 months
Mass and balance documentation	3 months
Notification of special loads including written information to the commander about dangerous goods	3 months

Table 2 – Reports

Reports	
Journey log	6 months
Flight report(s) for recording details of any occurrence, as prescribed in OPS 1.420, or any event which the commander deems necessary to report/record	3 months
Reports on exceedances of duty and/or reducing rest periods	3 months
Fuel and oil records	3 months

Table 3 – Flight crew records

Flight Crew Records	
Flight duty periods, Duty periods and Rest periods	15 months
Licence	As long as the flight crew member is exercising the privileges of the licence for the operator
Conversion training and checking	3 years
Command course (including checking)	3 years
Recurrent training and checking	3 years
Training and checking to operate in either pilot's seat	3 years
Recent experience (OPS 1.970 refers)	15 months
Route and aerodrome competence (OPS 1.975 refers)	3 years



Training and qualification for specific operations when required by OPS (e.g. EDTO, CATII/III operations)	3 years
Dangerous Goods training as appropriate	3 years

Table 4 – Cabin crew records

Cabin Crew Records	
Flight duty periods, Duty periods and Rest periods	15 months
Initial training, conversion and differences training (including checking)	As long as the cabin crew member is employed by the operator
Recurrent training and refresher (including checking)	Until 12 months after the cabin crew member has left the employ of the operator
Dangerous Goods training as appropriate	3 years

Table 5 – Records for other operations personnel

Records for other operations personnel	
Training/qualification records of other personnel for whom an approved training programme is required by OPS	Last 2 training records

Table 6 – Other records

Other Records	
Records on cosmic and solar radiation dosage	Until 12 months after the crew member has left the employ of the operator
Quality System records	5 years
Dangerous Goods Transport Document	3 months after completion of the flight
Dangerous Goods Acceptance Checklist	3 months after completion of the flight

**SUBPART Q****FLIGHT/DUTY TIME AND REST REQUIREMENTS****OPS 1.1090 Objective and Scope**

- (a) The operator shall, for the purpose of managing its fatigue-related safety risks, establish either
- (1) flight time, flight duty period, duty period limitations and rest period requirements that are within the prescriptive fatigue management regulations described in this Subpart; or
 - (2) a Fatigue Risk Management System (FRMS) in compliance with OPS 1.1140 for all operations; or
 - (3) an FRMS in compliance with OPS 1.1140 for part of its operations and the requirements of sub-paragraph (1) above for the remainder of its operations.
- (b) The operator shall ensure that for all its flights,
- (1) the flight and duty time limitations and rest scheme is in accordance with both;
 - (i) the provisions of this Subpart; and
 - (ii) any additional provisions that are applied by the Authority in accordance with the provisions of this Subpart for the purpose of maintaining safety.
 - (2) Flights are planned to be completed within the allowable flight duty period taking into account the time necessary for pre-flight duties, the flight and turn-around times.
 - (3) Duty rosters will be prepared and published sufficiently in advance to provide the opportunity for crew members to plan adequate rest.
- (c) Operators' responsibilities
- An operator shall;
- (1) publish duty rosters sufficiently in advance to provide the opportunity for crew members to plan adequate rest;
 - (2) nominate a home base for each crew member;
 - (3) specify reporting times that allow sufficient time for ground duties;
 - (4) be expected to appreciate the relationship between the frequencies and pattern of flight duty periods and rest periods and give due consideration to the cumulative effects of undertaking long duty hours interspersed with minimum rest;
 - (5) allocate duty patterns which avoid such undesirable practices as alternating day/night duties or the positioning of crew members so that a serious disruption of established sleep/work pattern occurs;
 - (6) plan local days free of duty and notify crew members in advance;



- (7) ensure that rest periods provide sufficient time to enable crew to overcome the effects of the previous duties and to be well rested by the start of the following flight duty period;
 - (8) ensure flight duty periods are planned to enable crew members to remain sufficiently free from fatigue so they can operate to a satisfactory level of safety under all circumstances;
 - (9) plan recurrent extended recovery rest periods and notify crew members sufficiently in advance;
 - (10) plan flight duties in order to be completed within the allowable flight duty period taking into account the time necessary for pre-flight duties, the sector and turnaround times; and
 - (11) change a schedule and/or crew arrangements if the actual operation exceeds the maximum flight duty period on more than 33% of the flight duties in that schedule during a scheduled seasonal period.
- (d) Crew members' responsibilities
- (1) A crew member shall not operate an aeroplane if he/she knows that he/she is suffering from or is likely to suffer from fatigue or feels unfit, to the extent that the flight may be endangered.
 - (2) Crew members should make optimum use of the opportunities and facilities for rest provided and plan and use their rest periods properly.
- (e) Responsibilities of Authority
- The Authority has established the following prescriptive regulations for flight time, flight duty period, duty period limitations and rest period requirements for the purpose of managing fatigue. These regulations are based upon scientific principles, knowledge and operational experience with the aim of ensuring that flight and cabin crew members are performing at an adequate level of alertness.
- (f) Variations
- (1) The Authority may grant variations to the requirements in this Subpart in accordance with applicable laws and procedures and in consultation with interested parties.
 - (2) Each operator will have to demonstrate to the Authority, using operational experience and taking into account other relevant factors such as current scientific knowledge, that its request for a variation produces an equivalent level of safety. Such variations will be accompanied with suitable mitigation measures where appropriate.

OPS 1.1095 Definitions

For the purposes of this Subpart, the following definitions shall apply:

'Acclimatised' means a state in which a crew member's circadian biological clock is synchronized to the time zone where the crew member is. A crew member is considered to be acclimatised to a 2-hour wide time zone surrounding the local time at the point of departure. When the local time at the place where a duty commences differs by more than 2 hours from the local time at the place where the next duty starts, the crew member, for the calculation of the maximum daily flight duty period, is considered to be acclimatised in accordance with the values as follows:



Time difference (h) between reference time and local time where the crew member starts the next duty	Time elapsed since reporting at reference time				
	<48	48-71:59	72:95:59	96-119:59	120
< 4	B	D	D	D	D
≤ 6	B	X	D	D	D
≤ 9	B	X	X	D	D
≤ 12	B	X	X	X	D

‘B’ means acclimatised to the local time of the departure time zone,

‘D’ means acclimatised to the local time where the crew member starts his/her next duty, and

‘X’ means that a crew member is in an unknown state of acclimatisation.

‘Accommodation’ means for the purpose of standby and split duty, a quiet and comfortable place not open to the public with the ability to control light and temperature, equipped with adequate furniture that provides a crew member with the possibility to sleep, with enough capacity to accommodate all crew members present at the same time and with access to food and drink.

‘Augmented flight crew’ means a flight crew which comprises more than the minimum number required for the operation of the aeroplane and in which each flight crew member can leave his/her post and be replaced by another appropriately qualified flight crew member.

‘Block time’ means the time between an aeroplane first moving from its parking place for the purpose of taking off until it comes to rest on the designated parking position and all engines or propellers are stopped.

‘Break’ means a period free of all duties, which counts as duty, being less than a rest period.

‘Delayed reporting’ means the postponement of a scheduled FDP by the operator before a crew member has left the place of rest.

‘Disruptive schedule’ means a crew member’s roster which disrupts the sleep opportunity during the optimal sleep time window by comprising a FDP or a combination of FDPs which encroach, start or finish during any portion of the day or of the night where a crew member is acclimatised. A schedule may be disruptive due to early starts, late finishes or night duties.

- (a) ‘early type’ of disruptive schedule means;
 - (1) for ‘early start’ a duty period starting in the period between 05:00 and 05:59 in the time zone to which a crew member is acclimatised, and
 - (2) for ‘late finish’ a duty period finishing in the period between 23:00 and 01:59 in the time zone to which a crew member is acclimatised.
- (b) ‘late type’ of disruptive schedule means;
 - (1) for ‘early start’ a duty period starting in the period between 05:00 and 06:59 in the time zone to which a crew member is acclimatised; and
 - (2) for ‘late finish’ a duty period finishing in the period between 00:00 and 01:59 in the time zone to which a crew member is acclimatised.



‘Duty’ means any task that a crew member is required to carry out associated with the business of an AOC holder. Unless provided for by these regulations, the Authority shall define whether and to what extent standby is to be accounted for as duty.

‘Duty period’ means a period which starts when a crew member is required by the operator to commence a duty and ends when the crew member is free from all duties.

‘Flight duty period’ means a flight duty period (FDP) is any time during which a person operates in an aircraft as a member of its crew. The FDP starts when the crew member is required by the operator to report for a flight or a series of flights; it finishes at the end of the last flight on which he/she is an operating crew member.

‘Flight time’ means for aeroplanes, the time between an aircraft first moving from its parking place for the purpose of taking off until it comes to rest on the designated parking position and all engines or propellers are shut down.

‘Home base’ means the location nominated by the operator to the crew member from where the crew member normally starts and ends a duty period or a series of duty periods and where, under normal conditions, the operator is not responsible for the accommodation of the crew member concerned.

‘Local day’ means a 24 hour period commencing at 00.00 local time.

‘Local night’ means a period of eight hours falling between 22.00 and 08.00 local time.

‘A single day free of duty’ means a single day free of duty shall include two local nights. A rest period may be included as part of the day off.

‘Operating crew member’ means a crew member who carries out his/her duties in an aircraft during a flight or during any part of a flight.

‘Other standby’ means a standby either at home or in a suitable accommodation.

‘Positioning’ means the transferring of a non-operating crew member from place to place, at the behest of the operator, excluding travelling time. Travelling time is defined as:

- time from home to a designated reporting place and vice versa,
- time for local transfer from a place of rest to the commencement of duty and vice versa.

‘Reference time’ means the local time at the reporting point situated in a 2-hour wide time zone band around the local time where a crew member is acclimatised.

‘Rest facility’ means a bunk or seat with leg and foot support suitable for crew members' sleeping on board an aircraft.

‘Reserve’ means a period of time during which a crew member is required by the operator to be available to receive an assignment for a FDP, positioning or other duty notified at least 10 hours in advance.

‘Rest period’ means a continuous, uninterrupted and defined period of time following duty or prior to duty, during which a crew member is free from all duties, standby and reserve.



‘Rotation’ means a duty or a series of duties, including at least one flight duty, and rest periods out of home base, starting at home base and ending when returning to home base for a rest period where the operator is no longer responsible for the accommodation of the crew member.

‘Sector’ means the segment of a FDP between an aircraft first moving for the purpose of taking off until it comes to rest after landing on the designated parking position.

‘Standby’ means a defined period of time during which a crew member is required by the operator to be available to receive an assignment for a flight, positioning or other duty without an intervening rest period.

Note: ‘Airport standby’ means a standby performed at the airport.

‘Suitable Accommodation’ means for the purpose of standby, split duty and rest, a separate room for each crew member located in a quiet environment and equipped with a bed, which is sufficiently ventilated, has a device for regulating temperature and light intensity, and access to food and drink.

‘Window of Circadian Low (WOCL)’ means the Window of Circadian Low (WOCL) is the period between 02.00 and 05.59. Within a band of three time zones the WOCL refers to home base time. Beyond these three time zones the WOCL refers to home base time for the first 48 hours after departure from home base time zone, and to local time thereafter.

OPS 1.1100 Flight and Duty Limitations

(a) Cumulative duty hours

The operator shall ensure that the total duty periods to which a crew member is assigned do not exceed:

- (1) 190 duty hours in any 28 consecutive days, spread as evenly as practicable throughout this period;
- (2) 110 duty hours in any 14 calendar days; and
- (3) 60 duty hours in any seven consecutive days.

(b) Limit on total block times

The operator shall ensure that the total block times of the flights on which an individual crew member is assigned as an operating crew member does not exceed;

- (1) 1000 block hours in any 12 consecutive calendar months;
- (2) 900 block hours in a calendar year; or
- (3) 100 block hours in any 28 consecutive days.

OPS 1.1105 Maximum Daily Flight Duty Period (FDP)

(a) Except for single-pilot operations and to emergency medical service operations;

- (1) The operator shall specify reporting times that realistically reflect the time for safety-related ground duties as approved by the Authority.



- (2) The maximum basic daily FDP is 13 hours.
- (3) These 13 hours will be reduced by 30 minutes for each sector from the third sector onwards with a maximum total reduction of two hours.
- (4) When the FDP starts in the WOCL, the maximum stated in point (2) and point (3) will be reduced by 100 % of its encroachment up to a maximum of two hours. When the FDP ends in or fully encompasses the WOCL, the maximum FDP stated in point (2) and point (3) will be reduced by 50 % of its encroachment.

Note: Flight duty time and block times limits must include all flying conducted by the crew member.

(b) Extensions

- (1) The maximum daily FDP can be extended by up to one hour.
- (2) Extensions are not allowed for a basic FDP of six sectors or more.
- (3) Where a FDP encroaches on the WOCL by up to two hours extensions are limited to up to four sectors.
- (4) Where an FDP encroaches on the WOCL by more than two hours extensions are limited to up to two sectors.
- (5) The maximum number of extensions is two in any seven consecutive days.
- (6) Where a FDP is planned to use an extension pre and post flight minimum rest is increased by two hours or post flight rest only is increased by four hours. Where the extensions are used for consecutive FDPs the pre and post rest between the two operations shall run consecutively.
- (7) When an FDP with extension starts in the period 22.00 to 04.59 the operator will limit the FDP to 11.45.

(c) Cabin Crew

For cabin crew being assigned to a flight or series of flights, the FDP of the cabin crew may be extended by the difference in reporting time between cabin crew and flight crew, as long as the difference does not exceed one hour.

(d) Operational Robustness

Planned schedules must allow for flights to be completed within the maximum permitted flight duty period. To assist in achieving this, operators will take action to change a schedule or crewing arrangements at the latest where the actual operation exceeds the maximum FDP on more than 33 % of the flights in that schedule during a scheduled seasonal period.

(e) Positioning

- (1) All the time spent on positioning is counted as duty.
- (2) Positioning after reporting but prior to operating shall be included as part of the FDP but



shall not count as a sector.

- (3) A positioning sector immediately following operating sector will be taken into account for the calculation of minimum rest as defined in OPS 1.1110 points (a)(1) and (a)(2) below.
- (f) Extended FDP (split duty)
- (1) The break on the ground within the FDP has a minimum duration of 3 consecutive hours.
 - (2) The break excludes the time allowed for post and pre-flight duties and travelling. The minimum total time for post and pre-flight duties and travelling is 30 minutes. The operator shall specify the actual times in its operations manual.
 - (3) The maximum FDP specified in OPS 1.1105 (a)(3) may be increased by up to 50% of the break.
 - (4) Suitable accommodation is provided either for a break of 6 hours or more or for a break that encroaches the window of circadian low (WOCL).
 - (5) In all other cases:
 - (i) accommodation is provided; and
 - (ii) any time of the actual break exceeding 6 hours or any time of the break that encroaches the WOCL does not count for the extension of the FDP.
 - (6) Split duty cannot be combined with in-flight rest.

OPS 1.1110 Rest

(a) Minimum rest

- (1) The minimum rest which must be provided before undertaking a flight duty period starting at home base shall be at least as long as the preceding duty period or 12 hours whichever is the greater;
- (2) The minimum rest which must be provided before undertaking a flight duty period starting away from home base shall be at least as long as the preceding duty period or 10 hours whichever is the greater; when on minimum rest away from home base, the operator must allow for an eight hour sleep opportunity taking due account of travelling and other physiological needs;
- (3) The operator will ensure that effects on crew members of time zone differences will be compensated by additional rest, as regulated by the Authority.
- (4) Notwithstanding (1) and (2), the Authority may grant reduced rest arrangements. Each operator will have to demonstrate to the Authority, using operational experience and taking into account other relevant factors, such as current scientific knowledge, that its request for reduced rest arrangements produces an equivalent level of safety.

(b) Rest periods



The operator shall ensure that the minimum rest provided as outlined above is increased periodically to a weekly rest period, being a 36-hour period including two local nights, such that there shall never be more than 168 hours between the end of one weekly rest period and the start of the next. As an exception, the Authority may decide that the second of those local nights may start from 20:00 hours if the weekly rest period has a duration of at least 40 hours.

OPS 1.1115 Extension of Flight Duty Period due to In-flight Rest

- (a) ‘Class 1 rest facility’ means a bunk or other surface that allows for a flat or near flat sleeping position. It reclines to at least 80° back angle to the vertical and is located separately from both the flight crew compartment and the passenger cabin in an area that allows the crew member to control light, and provides isolation from noise and disturbance.

‘Class 2 rest facility’ means a seat in an aircraft cabin that reclines at least 45° back angle to the vertical, has at least a pitch of 55 inches (137.5 cm), a seat width of at least 20 inches (50 cm) and provides leg and foot support. It is separated from passengers by at least a curtain to provide darkness and some sound mitigation, and is reasonably free from disturbance by passengers or crew members.

‘Class 3 rest facility’ means a seat in an aircraft cabin or flight crew compartment that reclines at least 40° from the vertical, provides leg and foot support and is separated from passengers by at least a curtain to provide darkness and some sound mitigation, and is not adjacent to any seat occupied by passengers.

- (b) the FDP is limited to 3 sectors.
- (c) the minimum in-flight rest period is a consecutive 90-minute period for each crew member and 2 consecutive hours for the flight crew members at control during landing.
- (d) The maximum daily FDP may be extended due to in-flight rest for flight crew:

Number of additional flight crew	Class 1 rest facilities	Class 2 rest facilities	Class 3 rest facilities
1	16 hours	15 hours	14 hours
2	17 hours	16 hours	15 hours

- (e) The limits specified in (d) may be increased by 1 hour for FDPs that include 1 sector of more than 9 hours of continuous flight time and a maximum of 2 sectors.
- (f) All time spent in the rest facility is counted as FDP.
- (g) The minimum rest at destination is at least as long as the preceding duty period, or 14 hours, whichever is greater.
- (h) A crew member does not start a positioning sector to become part of this operating crew on the same flight.

OPS 1.1120 Unforeseen Circumstances in Actual Flight Operations — Commander’s Discretion

- (a) Taking into account the need for careful control of these instances implied underneath, during the actual flight operation, which starts at the reporting time, the limits on flight duty, duty and rest periods prescribed in this Subpart may be modified in the event of unforeseen circumstances. Any



such modifications must be acceptable to the commander after consultation with all other crew members and must, in all circumstances, comply with the following:

- (1) The maximum FDP referred to in OPS 1.1105(a)(2) above may not be increased by more than two hours unless the flight crew has been augmented, in which case the maximum flight duty period may be increased by not more than three hours;
 - (2) If on the final sector within a FDP unforeseen circumstances occur after take-off that will result in the permitted increase being exceeded, the flight may continue to the planned destination or alternate;
 - (3) In the event of such circumstances, the rest period following the FDP may be reduced but never below the minimum rest defined in OPS 1.1110(a)(2);
- (b) The commander shall, in case of special circumstances, which could lead to severe fatigue, and after consultation with the crew members affected, reduce the actual flight duty time and/or increase the rest time in order to eliminate any detrimental effect on flight safety;
- (c) The operator shall ensure that:
- (1) The commander submits a report to the operator whenever a FDP is increased by his/her discretion or when a rest period is reduced in actual operation and
 - (2) Where the increase of a FDP or reduction of a rest period exceeds one hour, a copy of the report, to which the operator must add his comments, is sent to the Authority no later than 28 days after the event.

OPS 1.1122 Unforeseen circumstances in flight operations – delayed reporting

- (a) The operator may delay the reporting time in the event of unforeseen circumstances, if procedures for delayed reporting are established in the operations manual. The operator keeps records of delayed reporting. Delayed reporting procedures establish a notification time allowing a crew member to remain in his/her suitable accommodation when the delayed reporting procedure is activated. In such a case, if the crew member is informed of the delayed reporting time, the FDP is calculated as follows:
- (1) one notification of a delay leads to the calculation of the maximum FDP according to (3) or (4);
 - (2) if the reporting time is further amended, the FDP starts counting 1 hour after the second notification or at the original delayed reporting time if this is earlier;
 - (3) when the delay is less than 4 hours, the maximum FDP is calculated based on the original reporting time and the FDP starts counting at the delayed reporting time;
 - (4) when the delay is 4 hours or more, the maximum FDP is calculated based on the more limiting of the original or the delayed reporting time and the FDP starts counting at the delayed reporting time;
 - (5) as an exception to (1) and (2), when the operator informs the crew member of a delay of 10 hours or more in reporting time and the crew member is not further disturbed by the operator, such delay of 10 hours or more counts as a rest period.

OPS 1.1123 Reserve



- (a) If an operator assigns crew members to reserve, the following requirements shall apply;
- (1) reserve shall be in the roster;
 - (2) flight time specification schemes shall specify the following elements;
 - (i) the maximum duration of any single reserve period; and
 - (ii) the number of consecutive reserve days that may be assigned to a crew member.
 - (3) An assigned FDP counts from the reporting time.
 - (4) Reserve times do not count as duty period for the purpose of OPS 1.1100(a) and OPS 1.1110(a).
 - (5) The operator defines the maximum number of consecutive reserve days within the limits of OPS 1.1110(b).
 - (6) To protect an 8-hour sleep opportunity, the operator rosters a period of 8 hours, taking into account fatigue management principles, for each reserve day during which a crew member on reserve is not contacted by the operator.

OPS 1.1125 Standby

- (a) Airport standby
- (1) If not leading to the assignment of an FDP, airport standby is followed by a rest period as specified in OPS 1.1110(b).
 - (2) If an assigned FDP start during the airport standby, the following applies;
 - (i) the FDP counts from the start of the FDP. The maximum FDP is reduced by any time spent on standby in excess of 4 hours; and
 - (ii) the maximum combined duration of airport standby and assigned FDP as specified in OPS 1.1105 is 16 hours.
- (b) Standby other than airport standby;
- (1) the maximum duration of standby other than airport standby is 16 hours;
 - (2) The operator's standby procedures are designed to ensure that the combination of standby and FDP do not lead to more than 18 hours awake time;
 - (3) 25 % of time spent on standby other than airport standby counts as duty time for the purpose of OPS 1.1100(a);
 - (4) standby is followed by a rest period in accordance with OPS 1.1110;
 - (5) standby ceases when the crew member reports at the designated reporting point;
 - (6) if standby ceases within the first 6 hours, the maximum FDP counts from reporting;



- (7) if standby ceases after the first 6 hours, the maximum FDP is reduced by the amount of standby time exceeding 6 hours;
- (8) if the FDP is extended due to in-flight rest according to OPS 1.1115, or to split duty according to OPS 1.1105(f), the 6 hours of paragraph (6) and (7) are extended to 8 hours;
- (9) if standby starts between 23:00 and 07:00, the time between 23:00 and 07:00 does not count towards the reduction of the FDP under (6), (7) and (8) until the crew member is contacted by the operator; and
- (10) the response time between call and reporting time established by the operator allows the crew member to arrive from his/her place of rest to the designated reporting point within a reasonable time.

OPS 1.1130 Nutrition

A meal and drink opportunity must occur in order to avoid any detriment to a crew member's performance, especially when the FDP exceeds six hours.

OPS 1.1135 Flight Duty, Duty and Rest Period Records

(a) The operator shall ensure that crew member's records include:

- (1) block times;
- (2) start, duration and end of each duty or flight duty periods;
- (3) rest periods and days free of all duties;

and are maintained to ensure compliance with the requirements of this Subpart; copies of these records will be made available to the crew member upon request.

(b) If the records held by the operator under paragraph (a) do not cover all of his/her flight duty, duty and rest periods, the crew member concerned shall maintain an individual record of his/her:

- (1) block times;
- (2) start, duration and end of each duty or flight duty periods; and
- (3) rest periods and days free of all duties.

(c) A crew member shall present his/her records on request to any operator who employs his/her services before he/she commences a flight duty period.

(d) Records shall be preserved for at least 15 calendar months from the date of the last relevant entry.

(e) Additionally, operators shall separately retain all commander's discretion reports of extended flight duty periods, extended flight hours and reduced rest periods for at least three months after the event.

OPS 1.1140 Fatigue Management



(See AC OPS 1.1140)

- (a) The Authority has established FRMS regulations to authorise the operator to use a Fatigue Risk Management System (FRMS) to manage fatigue with the aim of ensuring that flight and cabin crew members are performing at an adequate level of alertness.
- (b) Where the operator adopts prescriptive fatigue management regulations for part or all of its operations, the Authority may approve, in exceptional circumstances, variations to these regulations on the basis of a risk assessment provided by the operator. Approved variations shall provide a level of safety equivalent to, or better than that achieved through the prescriptive fatigue management regulations.
- (c) The Authority shall approve the operator's FRMS before it may take the place of any or all of the prescriptive fatigue management regulations. An approved FRMS shall provide a level of safety equivalent to, or better than, the prescriptive fatigue management regulations.
- (d) The Authority shall establish a process to ensure that an FRMS provides a level of safety equivalent to, or better than, the prescriptive fatigue management regulations. As part of this process, the Authority shall:
 - (1) require that the operator establish maximum values for flight times and/or flight duty periods(s) and duty period(s), and minimum values for rest periods. These values shall be based upon scientific principles and knowledge, subject to safety assurance processes, and acceptable to the Authority;
 - (2) mandate a decrease in maximum values and an increase in minimum values in the event that the operator's data indicates these values are too high or too low, respectively; and
 - (3) approve any increase in maximum values or decrease in minimum values only after evaluating the operator's justification for such changes, based on accumulated FRMS experience and fatigue-related data.
- (e) Where the operator implements an FRMS to manage fatigue-related safety risks, the operator shall, as a minimum:
 - (1) incorporate scientific principles and knowledge within the FRMS;
 - (2) identify fatigue-related safety hazards and the resulting risks on an on-going basis;
 - (3) ensure that remedial actions, necessary to effectively mitigate the risks associated with the hazards, are implemented promptly;
 - (4) provide for continuous monitoring and regular assessment of the mitigation of fatigue risks achieved by such actions;
 - (5) integrate the FRMS with the operator's SMS; and
 - (6) provide for continuous improvement to the overall performance of the FRMS.

**SUBPART R****TRANSPORT OF DANGEROUS GOODS BY AIR****OPS 1.1145 General**

The operator must comply with the applicable provisions contained in the Technical Instructions, irrespective of whether:

- (a) the flight is wholly or partly within or wholly outside the territory of a State; or
- (b) a specific approval to carry dangerous goods in accordance with OPS 1.1155 is held.

OPS 1.1150 Terminology

- (a) Terms used in this Subpart have the following meanings:
 - (1) *Acceptance Check List*. A document used to assist in carrying out a check on the external appearance of packages of dangerous goods and their associated documents to determine that all appropriate requirements have been met.
 - (2) *Approval*. For the purposes only of compliance with OPS 1.1165(b)(2), an authorisation referred to in the Technical Instructions and issued by the Authority, for the transport of dangerous goods which are normally forbidden for transport or for other reasons, as specified in the Technical Instructions;
 - (3) *Cargo*. Any property carried on an aircraft other than mail and accompanied or mishandled baggage.
 - (4) *Cargo Aircraft*. Any aircraft which is carrying goods or property but not passengers. In this context the following are not considered to be passengers:
 - (i) A crew member;
 - (ii) The operator's employee permitted by, and carried in accordance with, the instructions contained in the Operations Manual;
 - (iii) An authorised representative of the Authority; or
 - (iv) A person with duties in respect of a particular shipment on board.
 - (5) *Dangerous Goods*. Articles or substances which are capable of posing a risk to health, safety, property or the environment and which are shown in the list of dangerous goods in the Technical Instructions or which are classified according to those Instructions.
 - (6) *Dangerous Goods Accident*. An occurrence associated with and related to the transport of dangerous goods which results in fatal or serious injury to a person or major property damage. (See AC OPS (AMC) 1.1150(a)(5) & (a)(6).)
 - (7) *Dangerous Goods Incident*. An occurrence, other than a dangerous goods accident, associated with and related to the transport of dangerous goods, not necessarily occurring on board an aircraft, which results in injury to a person, property damage, fire, breakage, spillage, leakage of fluid or radiation or other evidence that the integrity of the packaging



has not been maintained. Any occurrence relating to the transport of dangerous goods which seriously jeopardises the aircraft or its occupants is also deemed to constitute a dangerous goods incident. (See AC OPS (AMC) 1.1150(a)(5) & (a)(6).)

- (8) *Dangerous Goods Transport Document.* A document which is specified by the Technical Instructions. It is completed by the person who offers dangerous goods for air transport and contains information about those dangerous goods.
- (9) *Exemption.* For the purposes only of compliance with this Subpart, an authorisation referred to in the Technical Instructions and issued by all the authorities concerned, providing relief from the requirements of the Technical Instructions.
- (10) *Freight Container.* A freight container is an article of transport equipment for radioactive materials, designed to facilitate the transport of such materials, either packaged or unpackaged, by one or more modes of transport.

Note: See Unit Load Device where the dangerous goods are not radioactive materials.

- (11) *Handling Agent.* An agency which performs on behalf of the operator some or all of the latter's functions including receiving, loading, unloading, transferring or other processing of passengers or cargo.
- (12) *Overpack.* An enclosure used by a single shipper to contain one or more packages and to form one handling unit for convenience of handling and stowage. (Note: a unit load device is not included in this definition.)
- (13) *Package.* The complete product of the packing operation consisting of the packaging and its contents prepared for transport.
- (14) *Packaging.* Receptacles and any other components or materials necessary for the receptacle to perform its containment function.
- (15) *Serious Injury.* An injury which is sustained by a person in an accident and which:
 - (i) requires hospitalisation for more than 48 hours, commencing within seven days from the date the injury was received; or
 - (ii) results in a fracture of any bone (except simple fractures of fingers, toes or nose); or
 - (iii) involves lacerations which cause severe haemorrhage, nerve, muscle or tendon damage; or
 - (iv) involves injury to any internal organ; or
 - (v) involves second or third degree burns, or any burns affecting more than 5% of the body surface; or
 - (vi) involves verified exposure to infectious substances or injurious radiation.

- (16) *Technical Instructions.* The latest effective edition of the Technical Instructions for the Safe Transport of Dangerous Goods by Air, including the Supplement and any Addendum, approved and published by decision of the Council of the International Civil



Aviation Organisation (Doc 9284–AN/905).

- (17) *Unit Load Device.* Any type of aircraft container, aircraft pallet with a net, or aircraft pallet with a net over an igloo.

Note: An overpack is not included in this definition; for a container containing radioactive materials see the definition for freight container.

OPS 1.1155 Operators with a Specific Approval for the Transport of Dangerous Goods as Cargo

- (a) The operator shall not transport dangerous goods unless issued a specific approval for the transport of dangerous goods by the Authority.

Note: The carriage of dangerous goods must be included in the scope of the operator's safety management system (SMS).

- (b) Before the issue of an approval for the transport of dangerous goods, the operator shall satisfy the Authority that adequate training has been given, that all relevant documents (e.g. for ground handling, aeroplane handling, training) contain information and instructions on dangerous goods, and that there are procedures in place to ensure the safe handling of dangerous goods at all stages of air transport.

Note: The exemption or approval indicated in OPS 1.1165(b) (1) or (2) is in addition to the above and the conditions in (b) may not necessarily apply.

- (c) The Authority, as the State of the Operator, shall issue a specific approval for the transport of dangerous goods and ensure that the operator;
- (1) establishes a dangerous goods training programme that meets the requirements in the Technical Instructions, Part 1, Chapter 4, Table 1-4 and CAR DG, as appropriate.
 - (2) Details of the dangerous goods training programme shall be included in the operator's operations manuals.
 - (3) establishes dangerous goods policies and procedures in its operations manual to meet, at a minimum, the requirements of the Technical Instructions and CAR DG to enable operator personnel to:
 - (i) identify and reject undeclared or misdeclared dangerous goods, including COMAT classified as dangerous goods;
 - (ii) report to the Authority and the State in which it occurred any;
 - (A) occasions when undeclared or misdeclared dangerous goods are discovered in cargo or mail; and
 - (B) dangerous goods accidents and incidents;
 - (iii) report to the Authority and the State of Origin any occasions when dangerous goods are discovered to have been carried;



- (A) when not loaded, segregated, separated or secured in accordance with the Technical Instructions Part 7, Chapter 2; and/or
- (B) without information having been provided to the pilot-in-command;
- (4) accept, handle, store, transport, load and unload dangerous goods, including COMAT classified as dangerous goods as cargo on board an aircraft; and
- (5) provide the pilot-in-command with accurate and legible written or printed information concerning dangerous goods that are to be carried as cargo.

OPS 1.1157 Operators with No Specific Approval for the Transport of Dangerous Goods as Cargo

Operators with no specific approval to transport dangerous goods shall have;

- (a) established a dangerous goods training programme that meets the requirements of Annex 18, the applicable requirements of the Technical Instructions, Part 1, Chapter 4, and the requirements of CAR DG, as appropriate. Details of the dangerous goods training programme shall be included in the operator's operations manuals;
- (b) established dangerous goods policies and procedures in its operations manual to meet, at a minimum, the requirements of Annex 18, the Technical Instructions and CAR DG to allow operator personnel to:
 - (1) identify and reject undeclared dangerous goods, including COMAT classified as dangerous goods; and
 - (2) report to the appropriate authorities of the State in which it occurred and the Authority any:
 - (i) occasions when undeclared dangerous goods are discovered in cargo or mail; and
 - (ii) dangerous goods accidents and incidents.

OPS 1.1160 Scope

Articles and substances which would otherwise be classed as dangerous goods but which are not subject to the Technical Instructions in accordance with Part 1 and 8 of those Instructions are excluded from the provisions of this subpart providing that:

- (a) when placed on board with the approval of the operator to provide, during flight, medical aid to a patient (See AC OPS 1.1160(a)), they are:
 - (1) carried for use in flight; or are part of the permanent equipment of the aeroplane when it has been adapted for specialized use for medical evacuation; or carried on a flight made by the same aeroplane to collect a patient or after that patient has been delivered when it is impracticable to load or unload the goods at the time of the flight on which the patient is carried but with the intention that they be off-loaded as soon as practicable; and
 - (2) when placed on board with the approval of the operator to provide, during flight, medical aid to a patient the dangerous goods shall be restricted to the following and which must be kept in the position in which they are used or stowed securely when not in use and they are secured properly during take-off and landing and at all other times when deemed necessary by the commander in the interests of safety:



- (i) Gas cylinders which must have been manufactured specifically for the purpose of containing and transporting that particular gas;
 - (ii) Medications and other medical matter which must be under the control of trained personnel during the time when they are in use in the aeroplane;
 - (iii) Equipment containing wet cell batteries which must be kept and, when necessary secured, in an upright position to prevent spillage of the electrolyte
- (b) they are required to be aboard the aeroplane and are in accordance with the relevant regulations or for operating reasons (See AC OPS 1.1160(b)), although articles and substances intended as replacements or which have been removed for replacement must be transported on an aeroplane as specified in the Technical Instructions.
- (c) they are in baggage:
- (1) carried by passengers or crew members in accordance with the Technical Instructions. (See AC OPS (AMC) 1.1160(c)(1)); or
 - (2) which has been separated from its owner during transit (e.g.: lost baggage or improperly routed baggage) but which is carried by the operator. (See AC OPS 1.1160(c)(1)).

OPS 1.1165 Limitations on the Transport of Dangerous Goods

- (a) The operator shall take all reasonable measures to ensure that articles and substances or other goods declared as dangerous goods that are specifically identified by name or generally described in the Technical Instructions as being forbidden for transport under any circumstances are not carried on any aeroplane.
- (b) The operator shall not carry articles and substances or other goods declared as dangerous goods that are identified in the Technical Instructions as being forbidden for transport in normal circumstances unless the following requirements of those Instructions have been met (see AC OPS (AMC) 1.1165(b)) :
- (1) The necessary exemptions have been granted by all the States concerned under the requirements of the Technical Instructions; or
 - (2) an approval has been granted by all the State(s) concerned on those occasions when the Technical Instructions indicate that only such approval is required.

OPS 1.1195 Acceptance of Dangerous Goods

- (a) The operator shall not accept dangerous goods unless:
- (1) the package, overpack or freight container has been inspected in accordance with the acceptance procedures in the Technical Instructions.
 - (2) except when otherwise specified in the Technical Instructions, they are accompanied by two copies of a dangerous goods transport document.
 - (3) the English language is used for:
 - (i) package marking and labelling; and



- (ii) the dangerous goods transport document
in addition to any other language requirements.
- (b) The operator shall use an acceptance check list which shall allow for all relevant details to be checked and shall be in such form as will allow for the recording of the results of the acceptance check by manual, mechanical or computerised means.

OPS 1.1200 Inspection for Damage, Leakage or Contamination

- (a) The operator shall ensure that:
 - (1) Packages, overpacks and freight containers are inspected for evidence of leakage or damage immediately prior to loading on an aeroplane or into a unit load device, as specified in the Technical Instructions;
 - (2) A unit load device is not loaded on an aeroplane unless it has been inspected as required by the Technical Instructions and found free from any evidence of leakage from, or damage to, the dangerous goods contained therein;
 - (3) Leaking or damaged packages, overpacks or freight containers are not loaded on an aeroplane;
 - (4) Any package of dangerous goods found on an aeroplane and which appears to be damaged or leaking is removed or arrangements made for its removal by an appropriate authority or organisation. In this case the remainder of the consignment shall be inspected to ensure it is in a proper condition for transport and that no damage or contamination has occurred to the aeroplane or its load; and
 - (5) Packages, overpacks and freight containers are inspected for signs of damage or leakage upon unloading from an aeroplane or from a unit load device and, if there is evidence of damage or leakage, the area where the dangerous goods were stowed is inspected for damage or contamination.

OPS 1.1205 Removal of Contamination

- (a) The operator shall ensure that:
 - (1) any contamination resulting from found as a result of the leakage from, or damage to articles or packages containing of dangerous goods is removed without delay; and steps are taken to nullify any hazard as specified in the Technical Instructions; and
 - (2) an aeroplane which has been contaminated by radioactive materials is immediately taken out of service and not returned until the radiation level at any accessible surface and the non-fixed contamination are not more than the values specified in the Technical Instructions.
- (b) In the event of a non-compliance with any limit in the Technical Instructions applicable to radiation level or contamination,
 - (1) the operator must:
 - (i) ensure the shipper is informed if the non-compliance is identified during transport;



- (ii) take immediate steps to mitigate the consequences of the non-compliance;
 - (iii) communicate the non-compliance to the shipper and relevant competent authority(ies), respectively, as soon as practicable and immediately whenever an emergency situation has developed or is developing;
- (2) the operator must also, within the scope of his responsibilities:
- (i) investigate the non-compliance and its causes, circumstances and consequences;
 - (ii) take appropriate action, to remedy the causes and circumstances that led to the non-compliance and to prevent a recurrence of similar circumstances that led to the non-compliance;
 - (iii) communicate to the relevant competent authority(ies) on the causes of the non-compliance and on corrective or preventative actions taken or to be taken.

OPS 1.1210 Loading Restrictions

- (a) **Passenger Cabin and Flight Deck.** The operator shall ensure that dangerous goods are not carried in an aeroplane cabin occupied by passengers or on the flight deck, except as specified in the Technical Instructions.
- (b) **Cargo Compartments.** The operator shall ensure that dangerous goods are loaded, segregated, stowed and secured on an aeroplane as specified in the Technical Instructions.
- (c) **Dangerous Goods Designated for Carriage Only on Cargo Aircraft.** The operator shall ensure that packages of dangerous goods bearing the 'Cargo Aircraft Only' label are carried on a cargo aircraft and loaded as specified in the Technical Instructions.

OPS 1.1215 Provision of Information

- (a) **Information to personnel.** The operator must provide such information in the Operations Manual and/or other appropriate manuals as will enable personnel to carry out their responsibilities with regard to the transport of dangerous goods as specified in the Technical Instructions, including the actions to be taken in the event of emergencies involving dangerous goods. Where applicable, such information must also be provided to his/her handling agent.
- (b) **Information to Passengers and Other Persons**
 - (1) The operator shall ensure that information is promulgated as required by the Technical Instructions so that passengers are warned as to the types of goods which they are forbidden from transporting aboard an aeroplane; and
 - (2) The operator shall ensure that notices are provided at acceptance points for cargo giving information about the transport of dangerous goods.
- (c) **Information to the Commander.** the operator shall ensure that:
 - (1) written information is provided to the commander about the dangerous goods to be carried on an aeroplane, as specified in the Technical Instructions;



- (2) information for use in responding to in-flight emergencies is provided, as specified in the Technical Instructions;
- (3) a legible copy of the written information to the commander is retained on the ground at a readily accessible location until after the flight to which the written information refers. This copy, or the information contained in it, must be readily accessible to the aerodromes of last departure and next scheduled arrival point, until after the flight to which the information refers;
- (4) where dangerous goods are carried on a flight which takes place wholly or partially outside the territory of a State, the English language is used for the written information to the commander in addition to any other language requirements.

(See Table 1 of Appendix 1 to OPS 1.1065 for the document storage period).

(d) Information in the Event of an Aeroplane Incident or Accident.

- (1) The operator of an aeroplane which is involved in an aeroplane incident shall, on request, provide any information as required by the Technical Instructions.
- (2) The operator of an aeroplane which is involved in an aeroplane accident or serious incident shall without delay, provide any information as required by the Technical Instructions.
- (3) The operator of an aeroplane shall include procedures in appropriate manuals and accident contingency plans to enable this information to be provided.

(e) Information in the Event of an In-flight Emergency (See AC OPS (AMC) 1.1215(e)).

- (1) If an in-flight emergency occurs the commander shall, as soon as the situation permits, inform the appropriate air traffic services unit of any dangerous goods carried as cargo on board the aeroplane as specified in the Technical Instructions.

(f) The operator shall ensure that all personnel, including third-party personnel, involved in the acceptance, handling, loading and unloading of cargo are informed of the operator's specific approval and limitations with regard to the transport of dangerous goods.

OPS 1.1220 Training Programmes

(See AC OPS (AMC) 1.1220)

- (a) The operator shall establish and maintain staff training programmes, as required by the Technical Instructions, which shall be approved by the Authority.

Note: Details of the dangerous goods training programme including the policies and procedures regarding third-party personnel involved in the acceptance, handling, loading and unloading of dangerous goods cargo should be included in the operations manual.

- (b) The operator must ensure that staff receive training in the requirements commensurate with their responsibilities.
- (c) The operator must ensure that training is provided or verified upon the employment of a person in a position involving the transport of dangerous goods by air.



- (d) The operator shall ensure that all staff who receive training undertake a test to verify understanding of their responsibilities.
- (e) The operator shall ensure that all staff who require dangerous goods training receive recurrent training at intervals of no longer than 2 years.
- (f) The operator shall ensure that records of dangerous goods training are maintained for all staff as required by the Technical Instructions.
- (g) The operator shall ensure that his handling agent's staff are trained as required by the Technical Instructions.

OPS 1.1225 Dangerous Goods Incident and Accident Reports

(See AC OPS (AMC) 1.1225)

- (a) The operator shall report dangerous goods incidents and accidents to the Authority and the appropriate Authority in the State where the accident or incident occurred, as provided for in Appendix 1 to OPS 1.1225. The first report shall be dispatched within 72 hours of the event unless exceptional circumstances prevent this and include the details that are known at that time. If necessary, a subsequent report must be made as soon as possible giving whatever additional information has been established.
- (b) The operator shall also report to the Authority and the appropriate Authority in the State where the event occurred, the finding of undeclared or misdeclared dangerous goods discovered in cargo or passengers' baggage as provided for in Appendix 1 to OPS 1.1225. The first report must be dispatched within 72 hours of the discovery unless exceptional circumstances prevent this and include the details that are known at that time. If necessary, a subsequent report must be made as soon as possible giving whatever additional information has been established.



Appendix 1 to OPS 1.1225

Dangerous Goods Incident and Accident Reports

- (a) The operator shall ensure that any type of dangerous goods incident or accident is reported, irrespective of whether the dangerous goods are contained in cargo, mail, passengers' baggage or crew baggage. The finding of undeclared or misdeclared dangerous goods in cargo, mail or baggage shall also be reported.
- (b) The first report shall be dispatched within 72 hours of the event unless exceptional circumstances prevent this. It may be sent by any means, including e-mail, telephone or fax. This report shall include the details that are known at that time, under the headings identified in paragraph (c). If necessary, a subsequent report shall be made as soon as possible giving all the details that were not known at the time the first report was sent. If a report has been made verbally, written confirmation shall be sent as soon as possible.
- (c) The first and any subsequent report shall be as precise as possible and contain such of the following data that are relevant:
- (1) Date of the incident or accident or the finding of undeclared or misdeclared dangerous goods;
 - (2) Location, the flight number and flight date;
 - (3) Description of the goods and the reference number of the air waybill, pouch, baggage tag, ticket, etc.;
 - (4) Proper shipping name (including the technical name, if appropriate) and UN/ID number, when known;
 - (5) Class or division and any subsidiary risk;
 - (6) Type of packaging, and the packaging specification marking on it;
 - (7) Quantity;
 - (8) Name and address of the shipper, passenger, etc.;
 - (9) Any other relevant details;
 - (10) Suspected cause of the incident or accident;
 - (11) Action taken;
 - (12) Any other reporting action taken; and
 - (13) Name, title, address and telephone number of the person making the report.
- (d) Copies of relevant documents and any photographs taken should be attached to a report.

**SUBPART S****SECURITY****OPS 1.1235 Security Requirements**

The operator shall ensure that all appropriate personnel are familiar, and comply, with the relevant requirements of the national security programmes of the State of the Operator. This Subpart applies to international and domestic commercial operations.

OPS 1.1240 Training Programmes

(See AC OPS 1.1240)

- (a) The operator shall establish, maintain and conduct approved training programmes which enable the operator's crew members to take appropriate action to prevent acts of unlawful interference, such as sabotage or unlawful seizure of aeroplanes and to minimise the consequences of such events, should they occur. The training programme shall be compatible with the National Aviation Security Programme. Individual crew member shall have knowledge and competence of all relevant elements of the training programme.
- (b) The operator shall also establish and maintain a training programme to acquaint appropriate employees with preventive measures and techniques in relation to passengers, baggage, cargo, mail, equipment, stores and supplies intended for carriage on an aeroplane so that they contribute to the prevention of acts of sabotage or other forms of unlawful interference.

OPS 1.1245 Reporting Acts of Unlawful Interference

Following an act of unlawful interference on board an aeroplane the commander or, in his absence the operator, shall submit, without delay, a report of such an act to the designated local authority and the Authority in the State of the Operator.

OPS 1.1250 Aeroplane Search Procedure Checklist

The operator shall ensure that there is on board a checklist of the procedures to be followed in search of a bomb or Improvised Explosive Device (IED) in case of suspected sabotage and for inspecting aeroplanes for concealed weapons, explosives or other dangerous devices where a well-founded suspicion exists that the aeroplane may be the object of an act of unlawful interference. The checklist shall be supported by guidance on the appropriate course of action to be taken should a bomb or suspicious object be found and information on the least-risk bomb location specific to the aeroplane where provided by the Type Certificate holder.

OPS 1.1255 Flight Crew Compartment Security

- (a) In all aeroplanes which are equipped with a flight crew compartment door, this door shall be capable of being locked, and means or procedures acceptable to the Authority shall be provided or established by which the cabin crew can discretely notify the flight crew in the event of suspicious activity or security breaches in the cabin.
- (b) All passenger-carrying aeroplanes;
 - (1) of a maximum certificated take-off mass in excess of 54500 kg; or



- (2) of a maximum certificated take-off mass in excess of 45500 kg with a passenger seating capacity greater than 19; or
- (3) with a passenger seating capacity greater than 60;

shall be equipped with an approved flight crew compartment door that is designed to resist penetration by small arms fire and grenade shrapnel, and to resist forcible intrusions by unauthorised persons. This door shall meet the requirements of FAR 25/EASA CS-25 and be capable of being locked and unlocked from each pilot's station.

- (c) In all aeroplanes which are equipped with a flight crew compartment door in accordance with sub-paragraph (b):
 - (1) this door shall be closed and locked from the time all external doors are closed following embarkation until any such door is opened for disembarkation, except when necessary to permit access and egress by authorised persons in compliance with the National Civil Aviation Security Programme;
 - (2) means shall be provided for monitoring from either pilot's station the entire door area outside the flight crew compartment to identify persons requesting entry and to detect suspicious behaviour or potential threat.



SECTION 2

ADVISORY CIRCULARS (AC) AND ACCEPTABLE MEANS OF COMPLIANCE (AMC)

1 GENERAL

- 1.1 This Section contains Advisory Circulars (AC) and Acceptable Means of Compliance (AMC) that is based on JAA TGL 44 and has been agreed for inclusion in OPS 1.
- 1.2 Where a particular paragraph does not have an Advisory Circular or Acceptable Means of Compliance, it is considered that no supplementary material is required.

2 PRESENTATION

- 2.1 A numbering system has been used in which the Advisory Circular or Acceptable Means of Compliance uses the same number as the paragraph to which it refers. The number is introduced by the letters AC or AMC to distinguish the material from the regulation itself.
- 2.2 The acronyms AC and AMC also indicate the nature of the material and for this purpose the types of material are defined as follows:

Advisory Circulars (AC) provide guidelines on a subject matter, such as how to comply with a regulation.

Acceptable Means of Compliance (AMC) illustrates a means, or several alternative means, but not necessarily the only possible means by which a requirement can be met.



This Page Intentionally Left Blank

**AC/AMC B****GENERAL****AC to Appendix 1 to OPS 1.005 (a)
Operations of Performance Class B aeroplanes
See Appendix 1 to OPS 1.005(a)**

1. OPS 1.037; Safety Management System
For operations of performance class B aeroplanes, a simplified programme is sufficient which may consist of the following.
Collecting case based material (such as accident reports relating to the type of operation) and submit/distribute that information material to the crew members concerned; or
Collection and use of information from flight safety seminars (such as AOPA flight safety seminars etc.)
2. Appendix 2 to OPS 1.175; The management and organisation of an AOC holder
Supervision - The supervision of personnel may be undertaken by the appropriate nominated postholder(s) subject to time available.
3. OPS 1.915; Technical Log
One example of an acceptable way to fulfil the requirement for a Technical Log is given in Attachment 1 to this AC, where a Flight Log is presented. (See Attachment)
4. OPS 1.1070; MME – Maintenance Management Exposition:
The MME can be simplified as relevant to the operation to be conducted.
5. Subpart R; Transport of Dangerous goods by air
OPS 1.1145, 1.1155, 1.1160, 1.1165, 1.1215, 1.1220 and 1.1225 are applicable to all operators. The requirement in OPS 1.1165 may be fulfilled by the use of information pamphlets. The remainder of this Subpart applies only when the operator seeks or holds an approval to carry dangerous goods.
6. Subpart S; Security
OPS 1.1235 - Security requirements are applicable when operating in states where the national security programme applies to the operations covered in this Appendix.
OPS 1.1240 - Training programmes shall be adapted to the kind of operations performed. A self-study training programme may be acceptable for VFR operations.
7. Appendix 1 to OPS 1.005(a), subparagraph (a)(3)
Civil twilight ends in the evening when the centre of the sun's disc is 6 degrees below the horizon and begins in the morning when the centre of the sun's disc is 6 degrees below the horizon.
8. OPS 1.290(b)(2)
Where a Configuration Deviation List (CDL) is provided for aeroplanes of this size, it is included in the Aeroplane Flight Manual (AFM) or an equivalent document.



This Page Intentionally Left Blank



Attachment 1 to AC to Appendix 1 to OPS 1.005(a)

Address of operator :		Date:	CREW	LOAD	OIL	GROUND DE-ICING	Sheet number 0000001							
Aeroplane Type:		Name of commander:	Nb of Pax : _____	Engine 1 / Engine 2		Type of fluid : _____	Last release : _____							
Registration:		Name and duty of crew member	Mass (kg/lb)	Refilled : _____ / _____		Mixture : _____	Total aeroplane hours : _____							
			Cargo : _____	Total : _____ / _____		Time of de-icing	Total aeroplane landing : _____							
			Take-off : _____			Commenced : _____	Next maintenance due : _____							
						Finished : _____	In hours : _____							
							In landing : _____							
FLIGHT				PRE-FLIGHT	BLOCK TIME	AIRBORNE TIME	FUEL ON BOARD (ltrs/kg/lbs)							
Flight Nb :	From:	To :	Nb. of Ldg :	Name / Signature	Off :	On :	Time :	Take-off:	Ldg:	Time :	Uplift :	Take-off:	Ldg :	
Defects					Signature	Actions Taken					CAR 145.50 Release to Service			
I hereby certify that the work specified except as otherwise specified was carried out in accordance with the Republic of San Marino CAR GEN Subpart C and in respect to that work the aircraft/aircraft component is considered ready for release to service.														
0000001-1											Agreement number:			
						PN : _____ sn off: _____ sn on : _____					Date: Place: Time: Name: Signature:			
0000001-2											Agreement number:			
						PN : _____ sn off: _____ sn on : _____					Date: Place: Time: Name: Signature:			
						PN : _____ sn off: _____ sn on : _____								
MEL DEFERRED DEFECT					Captain's Acceptance	Daily check / Maintenance done :					Agreement number:			
Item MEL	Open Date	Category	Limit Date											
_____	_____	_____	_____											
_____	_____	_____	_____											
_____	_____	_____	_____											



This Page Intentionally Left Blank



AC OPS 1.035
Quality System
See OPS 1.035

1. Introduction
- 1.1 In order to show compliance with OPS 1.035, the operator should establish his Quality System in accordance with the instructions and information contained in the following paragraphs:
2. General
- 2.1 Terminology
 - a. The terms used in the context of the requirement for the operator's Quality System have the following meanings:
 - i. **Accountable Manager.** The person acceptable to the Authority who has corporate authority for ensuring that all operations and maintenance activities can be financed and carried out to the standard required by the Authority, and any additional requirements defined by the operator.
 - ii. **Quality Assurance.** All those planned and systematic actions necessary to provide adequate confidence that operational and maintenance practices satisfy given requirements.
 - iii. **Quality Manager.** The manager, acceptable to the Authority, responsible for the management of the Quality System, monitoring function and requesting corrective actions. In determining the acceptability by the Authority the following is taken into consideration:
 - A. the receipt of training, acceptable to the Authority, on quality management systems.
 - B. the receipt of training, acceptable to the Authority, on Quality Audit techniques.
 - C. having held a position previously within the Quality Assurance department of an organisation.
 - D. having a detailed knowledge of the approved organisation's procedures that describe the means, methods and practices of compliance with the San Marino regulations and standards.
- 2.2 Quality Policy
 - 2.2.1 The operator should establish a formal written Quality Policy Statement that is a commitment by the Accountable Manager as to what the Quality System is intended to achieve. The Quality Policy should reflect the achievement and continued compliance with OPS 1 together with any additional standards specified by the operator.
 - 2.2.2 The Accountable Manager is an essential part of the AOC holder's management organisation. With regard to the text in OPS 1.175 (h) and the above terminology, the term 'Accountable Manager' is intended to mean the Chief Executive / President / Managing Director / Director General / General Manager etc. of the operator's organisation, who by virtue of his position has overall responsibility (including financial) for managing the organisation .
 - 2.2.3 The Accountable Manager will have overall responsibility for the AOC holder's Quality System including the frequency, format and structure of the internal management evaluation activities as prescribed in paragraph 4.9 below.
- 2.3 Purpose of the Quality System
 - 2.3.1 The Quality System should enable the operator to monitor compliance with OPS 1, the Operations Manual, the Operator's Maintenance Management Exposition, and any other standards specified by that operator, or the Authority, to ensure safe operations and airworthy aircraft.
- 2.4 Quality Manager
 - 2.4.1 The function of the Quality Manager to monitor compliance with, and the adequacy of, procedures required to ensure safe operational practices and airworthy aeroplanes, as required by OPS 1.035(a), may be carried out by more than one person by means of different, but complementary, Quality Assurance Programmes.



- 2.4.2 The primary role of the Quality Manager is to verify, by monitoring activity in the fields of flight operations, maintenance, crew training and ground operations, that the standards required by the Authority, and any additional requirements defined by the operator, are being carried out under the supervision of the relevant nominated postholder.
- 2.4.3 The Quality Manager should be responsible for ensuring that the Quality Assurance Programme is properly established, implemented and maintained.
- 2.4.4 The Quality Manager should:
- Have direct access to the Accountable Manager;
 - Have access to all parts of the operator's and, as necessary, any sub-contractor's organisation.
- 2.4.5 In the case of small/very small operators (see paragraph 7.3 below), the posts of the Accountable Manager and the Quality Manager may be combined. However, in this event, quality audits should be conducted by independent personnel. In accordance with paragraph 2.4.4.b above, it will not be possible for the Accountable Manager to be one of the nominated postholders.
3. Quality System
- 3.1 Introduction
- 3.1.1 The operator's Quality System should ensure compliance with and adequacy of operational and maintenance activities requirements, standards and operational procedures.
- 3.1.2 The operator should specify the basic structure of the Quality System applicable to the operation.
- 3.1.3 The Quality System should be structured according to the size and complexity of the operation to be monitored ('small operators' see also paragraph 7 below).
- 3.2 Scope
- 3.2.1 As a minimum, the Quality System should address the following:
- The provisions of OPS 1;
 - The operator's additional standards and operating procedures;
 - The operator's Quality Policy;
 - The operator's organisational structure;
 - Responsibility for the development, establishment and management of the Quality System;
 - Documentation, including manuals, reports and records;
 - Quality Procedures;
 - Quality Assurance Programme;
 - The required financial, material, and human resources;
 - Training requirements.
- 3.2.2 The Quality System should include a feedback system to the Accountable Manager to ensure that corrective actions are both identified and promptly addressed. The feedback system should also specify who is required to rectify discrepancies and non-compliance in each particular case, and the procedure to be followed if corrective action is not completed within an appropriate timescale.
- 3.3 Relevant Documentation
- 3.3.1 Relevant documentation includes the relevant part of the Operations Manual and the Operator's Maintenance Management Exposition, which may be included in a separate Quality Manual.
- 3.3.2 In addition, relevant documentation should also include the following:
- Quality Policy;
 - Terminology;
 - Specified operational standards;
 - A description of the organisation;
 - The allocation of duties and responsibilities;



- f. Operational procedures to ensure regulatory compliance;
 - g. Safety Management System;
 - h. The Quality Assurance Programme, reflecting;
 - i. Schedule of the monitoring process;
 - ii. Audit procedures;
 - iii. Reporting procedures;
 - iv. Follow-up and corrective action procedures;
 - v. Recording system;
 - i. The training syllabus; and
 - j. Document control.
4. Quality Assurance Programme (See OPS 1.035(b).)
- 4.1 Introduction
- 4.1.1 The Quality Assurance Programme should include all planned and systematic actions necessary to provide confidence that all operations and maintenance are conducted in accordance with all applicable requirements, standards and operational procedures.
- 4.1.2 When establishing a Quality Assurance Programme, consideration should, at least, be given to the paragraphs 4.2 to 4.9 below:
- 4.2 Quality Inspection
- 4.2.1 The primary purpose of a quality inspection is to observe a particular event/action/document etc., in order to verify whether established operational procedures and requirements are followed during the accomplishment of that event and whether the required standard is achieved.
- 4.2.2 Typical subject areas for quality inspections are:
- a. Actual flight operations;
 - b. Ground De-icing/Anti-icing;
 - c. Flight Support Services;
 - d. Load Control;
 - e. Maintenance;
 - f. Technical Standards; and
 - g. Training Standards.
- 4.3 Audit
- 4.3.1 An audit is a systematic, and independent comparison of the way in which an operation is being conducted against the way in which the published operational procedures say it should be conducted.
- 4.3.2 Audits should include at least the following quality procedures and processes:
- a. A statement explaining the scope of the audit;
 - b. Planning and preparation;
 - c. Gathering and recording evidence; and
 - d. Analysis of the evidence.
- 4.3.3 Techniques which contribute to an effective audit are:
- a. Interviews or discussions with personnel;
 - b. A review of published documents;
 - c. The examination of an adequate sample of records;
 - d. The witnessing of the activities which make up the operation; and
 - e. The preservation of documents and the recording of observations.



4.4 Auditors

4.4.1 The operator should decide, depending on the complexity of the operation, whether to make use of a dedicated audit team or a single auditor. In any event, the auditor or audit team should have relevant operational and/or maintenance experience.

4.4.2 The responsibilities of the auditors should be clearly defined in the relevant documentation.

4.5 Auditor's Independence

4.5.1 Auditors should not have any day-to-day involvement in the area of the operation and/or maintenance activity which is to be audited. The operator may, in addition to using the services of full-time dedicated personnel belonging to a separate quality department, undertake the monitoring of specific areas or activities by the use of part-time auditors. The operator whose structure and size does not justify the establishment of full-time auditors, may undertake the audit function by the use of part-time personnel from within his own organisation or from an external source under the terms of an agreement acceptable to the Authority. In all cases the operator should develop suitable procedures to ensure that persons directly responsible for the activities to be audited are not selected as part of the auditing team. Where external auditors are used, it is essential that any external specialist is familiar with the type of operation and/or maintenance conducted by the operator.

4.5.2 The operator's Quality Assurance Programme should identify the persons within the company who have the experience, responsibility and authority to:

- a. Perform quality inspections and audits as part of on-going Quality Assurance;
- b. Identify and record any concerns or findings, and the evidence necessary to substantiate such concerns or findings;
- c. Initiate or recommend solutions to concerns or findings through designated reporting channels;
- d. Verify the implementation of solutions within specific timescales;
- e. Report directly to the Quality Manager.

4.6 Audit Scope

4.6.1 Operators are required to monitor compliance with the operational procedures they have designed to ensure safe operations, airworthy aircraft and the serviceability of both operational and safety equipment. In doing so they should as a minimum, and where appropriate, monitor:

- a. Organisation;
- b. Plans and Company objectives;
- c. Operational Procedures;
- d. Flight Safety;
- e. Operator certification (AOC/Operations specification);
- f. Supervision;
- g. Aircraft Performance;
- h. All Weather Operations;
- i. Communications and Navigational Equipment and Practices;
- j. Mass, Balance and Aircraft Loading;
- k. Instruments and Safety Equipment;
- l. Manuals, Logs, and Records;
- m. Flight and Duty Time Limitations, Rest Requirements, and Scheduling;
- n. Aircraft Maintenance/Operations interface;
- o. Use of the MEL;
- p. Maintenance Programmes and Continued Airworthiness;
- q. Airworthiness Directives management;
- r. Maintenance Accomplishment;



- s. Defect Deferral;
 - t. Flight Crew;
 - u. Cabin Crew;
 - v. Dangerous Goods;
 - w. Security;
 - x. Training.
- 4.7 Audit Scheduling
- 4.7.1 A Quality Assurance Programme should include a defined audit schedule and a periodic review cycle area by area. The schedule should be flexible, and allow unscheduled audits when trends are identified. Follow-up audits should be scheduled when necessary to verify that corrective action was carried out and that it was effective.
- 4.7.2 The operator should establish a schedule of audits to be completed during a specified calendar period. All aspects of the operation should be reviewed within every period of 12 months in accordance with the programme unless an extension to the audit period is accepted as explained below. the operator may increase the frequency of audits at his discretion but should not decrease the frequency without the agreement of the Authority. It is considered unlikely that an interval between audits greater than 24 months would be acceptable for any audit topic.
- 4.7.3 When the operator defines the audit schedule, significant changes to the management, organisation, operation, or technologies should be considered as well as changes to the regulatory requirements.
- 4.8 Monitoring and Corrective Action
- 4.8.1 The aim of monitoring within the Quality System is primarily to investigate and judge its effectiveness and thereby to ensure that defined policy, operational, and maintenance standards are continuously complied with. Monitoring activity is based upon quality inspections, audits, corrective action and follow-up. the operator should establish and publish a quality procedure to monitor regulatory compliance on a continuing basis. This monitoring activity should be aimed at eliminating the causes of unsatisfactory performance.
- 4.8.2 Any non-compliance identified as a result of monitoring should be communicated to the manager responsible for taking corrective action or, if appropriate, the Accountable Manager. Such non-compliance should be recorded, for the purpose of further investigation, in order to determine the cause and to enable the recommendation of appropriate corrective action.
- 4.8.3 The Quality Assurance Programme should include procedures to ensure that corrective actions are taken in response to findings. These quality procedures should monitor such actions to verify their effectiveness and that they have been completed. Organisational responsibility and accountability for the implementation of corrective action resides with the department cited in the report identifying the finding. The Accountable Manager will have the ultimate responsibility for resourcing the corrective action and ensuring, through the Quality Manager, that the corrective action has re-established compliance with the standard required by the Authority, and any additional requirements defined by the operator.
- 4.8.4 Corrective action
- a. Subsequent to the quality inspection/audit, the operator should establish:
 - i. The seriousness of any findings and any need for immediate corrective action;
 - ii. The origin of the finding;
 - iii. What corrective actions are required to ensure that the non-compliance does not recur;
 - iv. A schedule for corrective action;
 - v. The identification of individuals or departments responsible for implementing corrective action;
 - vi. Allocation of resources by the Accountable Manager, where appropriate.
- 4.8.5 The Quality Manager should:
- a. Verify that corrective action is taken by the manager responsible in response to any finding of non-compliance;



- b. Verify that corrective action includes the elements outlined in paragraph 4.8.4 above;
- c. Monitor the implementation and completion of corrective action;
- d. Provide management with an independent assessment of corrective action, implementation and completion;
- e. Evaluate the effectiveness of corrective action through the follow-up process.

4.9 Management Evaluation

4.9.1 A management evaluation is a comprehensive, systematic, documented review by the management of the Quality System, operational policies and procedures, and should consider:

- a. The results of quality inspections, audits and any other indicators;
- b. The overall effectiveness of the management organisation in achieving stated objectives.

4.9.2 A management evaluation should identify and correct trends, and prevent, where possible, future non-conformities. Conclusions and recommendations made as a result of an evaluation should be submitted in writing to the responsible manager for action. The responsible manager should be an individual who has the authority to resolve issues and take action.

4.9.3 The Accountable Manager should decide upon the frequency, format, and structure of internal management evaluation activities.

4.10 Recording

4.10.1 Accurate, complete, and readily accessible records documenting the results of the Quality Assurance Programme should be maintained by the operator. Records are essential data to enable the operator to analyse and determine the root causes of non-conformity, so that areas of non-compliance can be identified and addressed.

4.10.2 The following records should be retained for a period of 5 years:

- a. Audit Schedules;
- b. Quality inspection and Audit reports;
- c. Responses to findings;
- d. Corrective action reports;
- e. Follow-up and closure reports; and
- f. Management Evaluation reports.

5. Quality Assurance Responsibility for Sub-Contractors

5.1 Sub-Contractors

5.1.1 Operators may decide to sub-contract out certain activities to external agencies for the provision of services related to areas such as:

- a. Ground De-icing/Anti-icing;
- b. Maintenance;
- c. Ground handling;
- d. Flight Support (including Performance calculations, flight planning, navigation database and dispatch);
- e. Training;
- f. Manual preparation.

5.1.2 The ultimate responsibility for the product or service provided by the sub-contractor always remains with the operator. A written agreement should exist between the operator and the sub-contractor clearly defining the safety-related services and quality to be provided. The sub-contractor's safety-related activities relevant to the agreement should be included in the operator's Quality Assurance Programme.

5.1.3 The operator should ensure that the sub-contractor has the necessary authorisation/approval when required and commands the resources and competence to undertake the task. If the operator requires the sub-contractor to conduct activity which exceeds the sub-contractor's authorisation/approval, the operator is responsible for ensuring that the sub-contractor's quality assurance takes account of such



additional requirements.

6. Quality System Training

6.1 General

6.1.1 The operator should establish effective, well planned and resourced quality related briefing for all personnel.

6.1.2 Those responsible for managing the Quality System should receive training covering:

- a. An introduction to the concept of the Quality System;
- b. Quality management;
- c. The concept of Quality Assurance;
- d. Quality manuals;
- e. Audit techniques;
- f. Reporting and recording; and
- g. The way in which the Quality System will function in the company.

6.1.3 Time should be provided to train every individual involved in quality management and for briefing the remainder of the employees. The allocation of time and resources should be governed by the size and complexity of the operation concerned.

6.2 Sources of Training

6.2.1 Quality management courses are available from the various National or International Standards Institutions, and the operator should consider whether to offer such courses to those likely to be involved in the management of Quality Systems. Operators with sufficient appropriately qualified staff should consider whether to carry out in-house training.

7. Organisations with 20 or less full time employees

7.1 Introduction

The requirement to establish and document a Quality System, and to employ a Quality Manager applies to all operators. References to large and small operators elsewhere in the requirements are governed by aircraft capacity (i.e. more or less than 20 seats) and by mass (greater or less than 10 tonnes Maximum Take-off Mass). Such terminology is not relevant when considering the scale of an operation and the Quality System required. In the context of quality systems therefore, operators should be categorised according to the number of full time staff employees.

7.2 Scale of Operation

7.2.1 Operators who employ 5 or less full time staff are considered to be 'very small' while those employing between 6 and 20 full time employees are regarded as 'small' operators as far as quality systems are concerned. Full-time in this context means employed for not less than 35 hours per week excluding vacation periods.

7.2.2 Complex quality systems could be inappropriate for small or very small operators and the clerical effort required to draw up manuals and quality procedures for a complex system may stretch their resources. It is therefore accepted that such operators should tailor their quality systems to suit the size and complexity of their operation and allocate resources accordingly.

7.3 Quality Systems for small/very small Operators

7.3.1 For small and very small operators it may be appropriate to develop a Quality Assurance Programme that employs a checklist. The checklist should have a supporting schedule that requires completion of all checklist items within a specified timescale, together with a statement acknowledging completion of a periodic review by top management. An occasional independent overview of the checklist content and achievement of the Quality Assurance should be undertaken.

7.3.2 The 'small' operator may decide to use internal or external auditors or a combination of the two. In these circumstances it would be acceptable for external specialists and or qualified organisations to perform the quality audits on behalf of the Quality Manager.

7.3.3 If the independent quality audit function is being conducted by external auditors, the audit schedule should be shown in the relevant documentation.



7.3.4 Whatever arrangements are made, the operator retains the ultimate responsibility for the Quality System and especially the completion and follow-up of corrective actions.



AMC OPS 1.035
Quality System – Organisation Examples
 See OPS 1.035

The following diagrams illustrate two typical examples of Quality organisations.

1. Quality System within the AOC holder’s organisation when the AOC holder also holds an AMO approval.

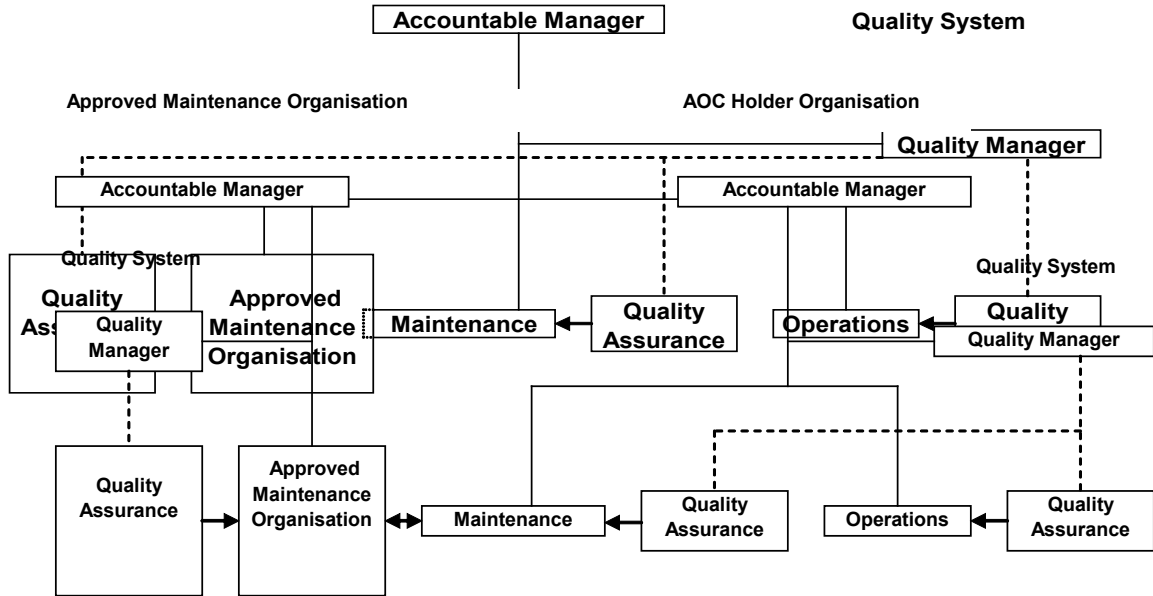

2. Quality Systems related to an AOC holder’s organisation where aircraft maintenance is contracted out to an approved organisation which is not integrated with the AOC holder:

Note: The Quality System and Quality Audit Programme of the AOC holder should assure that the maintenance carried out by the approved organisation is in accordance with requirements specified by the AOC holder.

AMC OPS 1.037
Safety Management Systems (See OPS 1.037)

1. Guidance material for the establishment of a Safety Management System and Flight Data Monitoring can be found in:
 - a. ICAO Doc 9376 (Preparation of an Operational Manual).
 - b. ICAO Doc 9859 (Safety Management Manual)

AC OPS 1.037(c)
Occurrence Reporting Scheme
 See OPS 1.037(c)

1. The overall objective of the scheme described in OPS 1.037(c) is to use reported information to improve the level of flight safety and not to attribute blame.
2. The detailed objectives of the scheme are:
 - a. To enable an assessment of the safety implications of each relevant incident and accident to be made, including previous similar occurrences, so that any necessary action can be initiated; and
 - b. To ensure that knowledge of relevant incidents and accidents is disseminated so that other persons and organisations may learn from them.
3. The scheme is an essential part of the overall monitoring function; it is complementary to the normal day to day procedures and ‘control’ systems and is not intended to duplicate or supersede any of them. The scheme is a tool to identify those occasions where routine procedures have failed. (Occurrences that have to be reported and responsibilities for submitting reports are described in OPS 1.420.)



4. Occurrences should remain in the database when judged reportable by the person submitting the report as the significance of such reports may only become obvious at a later date.

AC OPS 1.037(d)**Flight Data Monitoring Programme****See OPS 1.037(d)****See Appendix to AC OPS 1.037(d)**

1. Flight Data Monitoring (FDM) is the pro-active and non-punitive use of digital flight data from routine operations to improve aviation safety.
2. The manager of the safety management system, which includes the FDM programme, is accountable for the discovery of issues and the transmission of these to the relevant manager(s) responsible for the process(es) concerned. The latter are accountable for taking appropriate and practicable safety action within a reasonable period of time that reflects the severity of the issue.

Note: While the operator may contract the operation of a flight data analysis programme to another party the overall responsibility remains with the operator's safety management system manager.

3. An FDM programme will allow the operator to:
 - 3.1 Identify areas of operational risk and quantify current safety margins.
 - 3.2 Identify and quantify operational risks by highlighting when non-standard, unusual or unsafe circumstances occur.
 - 3.3 Use the FDM information on the frequency of occurrence, combined with an estimation of the level of severity, to assess the safety risks and to determine which may become unacceptable if the discovered trend continues.
 - 3.4 Put in place appropriate procedures for remedial action once an unacceptable risk, either actually present or predicted by trending, has been identified.
 - 3.5 Confirm the effectiveness of any remedial action by continued monitoring.
4. Flight Data Monitoring Analysis Techniques:
 - 4.1 Exceedance Detection: This looks for deviations from flight manual limits, and standard operating procedures. A set of core events should be selected to cover the main areas of interest to the operator. A sample list is in the Appendix to AC OPS 1.037(d). The event detection limits should be continuously reviewed to reflect the operator's current operating procedures.
 - 4.2 All Flights Measurement: A system that defines what is normal practice. This may be accomplished by retaining various snapshots of information from each flight.
 - 4.3 Statistics: A series of measures collected to support the analysis process. These would be expected to include the numbers of flights flown and analysed, aircraft and sector details sufficient to generate rate and trend information.
5. Flight Data Monitoring Analysis, Assessment and Process Control Tools: The effective assessment of information obtained from digital flight data is dependent on the provision of appropriate information technology tool sets. A programme suite may include: Annotated data trace displays, engineering unit listings, visualisation for the most significant incidents, access to interpretative material, links to other safety information, and statistical presentations.
6. Education and Publication: Sharing safety information is a fundamental principle of aviation safety in helping to reduce accident rates the operator should pass on the lessons learnt to all relevant personnel and, where appropriate, industry. Similar media to air safety systems may be used. These may include: Newsletters, flight safety magazines, highlighting examples in training and simulator exercises, periodic reports to industry and the regulatory authority.



7. Accident and incident data requirements specified in OPS 1.160 take precedence over the requirements of an FDM programme. In these cases the FDR data should be retained as part of the investigation data and may fall outside the de-identification agreements.
8. Every crew member has a responsibility to report events described in OPS 1.085(b) using the company occurrence reporting scheme detailed in OPS 1.037(c). Mandatory Occurrence Reporting is a requirement under OPS 1.420. Significant risk-bearing incidents detected by FDM will therefore normally be the subject of mandatory occurrence reporting by the crew. If this is not the case then they should submit a retrospective report that will be included under the normal safety management system process without prejudice.
9. The data recovery strategy should ensure a sufficiently representative capture of flight information to maintain an overview of operations. Data analysis should be performed sufficiently frequently to enable action to be taken on significant safety issues.
10. The data retention strategy should aim to provide the greatest safety benefits practicable from the available data. A full data set should be retained until the action and review processes are complete; thereafter, a reduced data set relating to closed issues can be maintained for longer term trend analysis. Programme managers may wish to retain samples of de-identified full-flight data for various safety purposes (detailed analysis, training, benchmarking etc.).
11. Data Access and Security policy should restrict information access to authorised persons. When data access is required for airworthiness and maintenance purposes, a procedure should be in place to prevent disclosure of crew identity.
12. Procedure Document; this document signed by all parties (airline management, flight crew member representatives nominated either by the union or the flight crew themselves) will, as a minimum, define:
 - a. The aim of the FDM programme.
 - b. A data access and security policy that should restrict access to information to specifically authorised persons identified by their position.
 - c. The method to obtain de-identified crew feedback on those occasions that require specific flight follow-up for contextual information; where such crew contact is required the authorised person(s) need not necessarily be the programme manager, or safety manager, but could be a third party (broker) mutually acceptable to unions or staff and management.
 - d. The data retention policy and accountability including the measures taken to ensure the security of the data.
 - e. The conditions under which, on rare occasions, advisory briefing or remedial training should take place; this should always be carried out in a constructive and non-punitive manner.
 - f. The conditions under which the confidentiality may be withdrawn for reasons of gross negligence or significant continuing safety concern.
 - g. The participation of flight crew member representative(s) in the assessment of the data, the action and review process and the consideration of recommendations.
 - h. The policy for publishing the findings resulting from FDM.
13. Airborne systems and equipment used to obtain FDM data will range from an already installed full Quick Access Recorder, in a modern aircraft with digital systems, to a basic crash protected recorder in an older or less sophisticated aircraft. The analysis potential of the reduced data set available in the latter case may reduce the safety benefits obtainable. the operator shall ensure that FDM use does not adversely affect the serviceability of equipment required for accident investigation.

AMC OPS 1.037(f)
Flight Safety Documents System
See OPS 1.037(f)

1. Introduction



- 1.1 The following material provides guidance on the organisation and development of the operator's flight safety documents system. It should be understood that the development of a flight safety documents system is a complete process, and changes to each document comprising the system may affect the entire system. Guidelines applicable to the development of operational documents have been produced by government and industry sources and are available to operators. Nevertheless, it may be difficult for operators to make the best use of these guidelines, since they are distributed across a number of publications.
 - 1.2 Furthermore, guidelines applicable to operational documents development tend to focus on a single aspect of documents design, for example, formatting and typography. Guidelines rarely cover the entire process of operational documents development. It is important for operational documents to be consistent with each other, and consistent with regulations, manufacturer requirements and Human Factors principles. It is also necessary to ensure consistency across departments as well as consistency in application. Hence the emphasis on an integrated approach, based on the notion of the operational documents as a complete system.
 - 1.3 The guidelines in this AMC address the major aspects of the operator's flight safety documents system development process, with the aim of ensuring compliance. The guidelines are based not only upon scientific research, but also upon current best industry practices, with an emphasis on a high degree of operational relevance.
2. Organisation
 - 2.1 A flight safety documents system should be organised according to criteria which ensure easy access to information required for flight and ground operations contained in the various operational documents comprising the system and which facilitate management of the distribution and revision of operational documents.
 - 2.2 Information contained in a flight safety documents system should be grouped according to the importance and use of the information, as follows:
 - a. time-critical information, e.g., information that can jeopardize the safety of the operation if not immediately available;
 - b. time-sensitive information, e.g., information that can affect the level of safety or delay the operation if not available in a short time period;
 - c. frequently used information;
 - d. reference information, e.g., information that is required for the operation but does not fall under b) or c) above; and
 - e. information that can be grouped based on the phase of operation in which it is used.
 - 2.3 Time-critical information should be placed early and prominently in the flight safety documents system.
 - 2.4 Time-critical information, time-sensitive information, and frequently used information should be placed in cards and quick-reference guides.
 3. Validation

The flight safety documents system should be validated before deployment, under realistic conditions. Validation should involve the critical aspects of the information use, in order to verify its effectiveness. Interactions among all groups that can occur during operations should also be included in the validation process.
 4. Design
 - 4.1 A flight safety documents system should maintain consistency in terminology and in the use of standard terms for common items and actions.
 - 4.2 Operational documents should include a glossary of terms, acronyms and their standard definition, updated on a regular basis to ensure access to the most recent terminology. All significant terms, acronyms and abbreviations included in the flight documents system should be defined.



4.3 A flight safety documents system should ensure standardization across document types, including writing style, terminology, use of graphics and symbols, and formatting across documents. This includes a consistent location of specific types of information, consistent use of units of measurement and consistent use of codes.

4.4 A flight safety documents system should include a master index to locate, in a timely manner, information included in more than one operational document.

Note: The master index must be placed in the front of each document and consist of no more than three levels of indexing. Pages containing abnormal and emergency information must be tabbed for direct access.

4.5 A flight safety documents system should comply with the requirements of the operator's Quality System, if applicable.

5. Deployment

Operators should monitor deployment of the flight safety documents system, to ensure appropriate and realistic use of the documents, based on the characteristics of the operational environment and in a way which is both operationally relevant and beneficial to operational personnel. This monitoring should include a formal feedback system for obtaining input from operational personnel.

6. Amendment

6.1 Operators should develop an information gathering, review, distribution and revision control system to process information and data obtained from all sources relevant to the type of operation conducted, including, but not limited to, the State of the Operator, State of design, State of Registry, manufacturers and equipment vendors.

Note: Manufacturers provide information for the operation of specific aircraft that emphasizes the aircraft systems and procedures under conditions that may not fully match the requirements of operators. Operators should ensure that such information meets their specific needs and those of the local authority.

6.2 Operators should develop an information gathering, review and distribution system to process information resulting from changes that originate within the operator, including:

- a. changes resulting from the installation of new equipment;
- b. changes in response to operating experience;
- c. changes in the operator's policies and procedures;
- d. in the operator certificate; and
- e. changes for purposes of maintaining cross fleet standardization.

Note: Operators should ensure that crew coordination philosophy, policies and procedures are specific to their operation.

6.3 A flight safety documents system should be reviewed:

- a. on a regular basis (at least once a year);
- b. after major events (mergers, acquisitions, rapid growth, downsizing, etc.);
- c. after technology changes (introduction of new equipment); and
- d. after changes in safety regulations.

6.4 Operators should develop methods of communicating new information. The specific methods should be responsive to the degree of communication urgency.



Note: As frequent changes diminish the importance of new or modified procedures, it is desirable to minimize changes to the flight safety documents system.

- 6.5 New information should be reviewed and validated considering its effects on the entire flight safety documents system.
- 6.6 The method of communicating new information should be complemented by a tracking system to ensure currency by operational personnel. The tracking system should include a procedure to verify that operational personnel have the most recent updates.

AC OPS 1.037(g) RFFS Category

1. Purpose and scope

1.1 Introduction

The purpose of this guidance material is to provide guidance for assessing the level of RFFS deemed acceptable by aeroplane operators using aerodromes for differing purposes. This guidance does not relieve the operator from the obligation to ensure that an acceptable level of protection is available for the aeroplane intended to be used.

1.2 Basic concepts

- 1.2.1 For flight planning purposes an aeroplane operator should utilize an aerodrome whose RFFS category matches or exceeds the aeroplane's RFFS category. Some aerodromes currently used do not meet these requirements. This level of RFFS protection does not take into account aeroplanes for which the aerodrome is selected as an alternative aerodrome.
- 1.2.2 If an aerodrome is exposed to a temporary reduction of its RFFS capability, ICAO requires that: "Changes in the level of protection normally available at an aerodrome for rescue and fire fighting shall be notified to the appropriate air traffic services units and aeronautical information services units to enable those units to provide the necessary information to arriving and departing aircraft. When such a change has been corrected, the above units shall be advised accordingly."
- 1.2.3 In order to determine the acceptability of an aerodrome RFFS protection level, the operator should consider:
- a. *for a departure or destination aerodrome;*

the difference between the aerodrome RFFS category and the aeroplane RFFS category, and the frequency of flights to that aerodrome; and
 - b. *for an alternate aerodrome;*

the difference between the aerodrome RFFS category and the aeroplane RFFS category, and the probability that this alternate aerodrome will be used.
- 1.2.4 The intention is that the operator will consider the available RFFS as one element of a risk assessment process conducted under their Safety Management System, to ensure that the overall safety of the operation can be maximised. This risk assessment would also include considerations of aerodrome facilities, availability, terrain, weather conditions etc. to ensure that the most appropriate aerodrome was selected.
- 1.2.4 The following guidance is intended to assist operators in making the assessment with due consideration of the basic principles described above. It is not intended that this guidance limit or regulate the operation of an aerodrome.

2. Glossary of terms

Aerodrome RFFS category. The RFFS category for a given aerodrome, as published in the appropriate Aeronautical Information Publication (AIP).

Aeroplane RFFS category. The category derived from ICAO Annex 14, Volume I, Table 9-1 for a given aeroplane type.



Temporary downgrade. RFFS category as notified, including by NOTAM, and resulting from the downgrade of the level of RFFS protection available at an aerodrome.

3. Minimum acceptable aerodrome RFFS category

3.1 Planning

3.1.1 In principle, the published RFFS category for each of the aerodromes used for a given flight should be equal to or better than the aeroplane's RFFS category. However, if the aeroplane's RFFS category is not available at one or more of the aerodromes required to be specified in the operational flight plan, the operator should ensure that the aerodrome a level of RFFS category which is deemed acceptable based on a risk assessment conducted as part of the operator's safety management system (SMS). When establishing acceptable levels of RFFS category for these situations, the operator may use the criteria in Table below. Notwithstanding these criteria, the operator may determine other acceptable levels of RFFS category in accordance with paragraph 3.1.3 below.

3.1.1.1 Intended operations

3.1.1.1 Intended operations to aerodromes with RFFS categories below the levels specified in Annex 14, Volume I, Chapter 9, 9.2, should be coordinated between the aeroplane operator and the aerodrome operator.

3.1.1.2 For departure and destination aerodromes, during flight planning, the acceptable RFFS protection level should equal or exceed the values specified in Table 1.



Table 1

Acceptable aerodrome category for rescue and fire-fighting (departure and destination aerodrome)

<p>Aerodromes (Required to be specified in the operational flight plan)</p> <p><i>Note: If an individual aerodrome serves more than one purpose, the highest required category corresponding to that purpose at the time of expected use applies.</i></p>	<p>Acceptable aerodrome RFFS category (Based on published aerodrome RFFS category, including any modification by NOTAM)</p>
<p>Departure and destination aerodrome</p>	<p>RFFS category for each aerodrome should be equal to or better than the aeroplane RFFS category.</p> <p>Where a suitable risk assessment has been conducted by the operator:</p> <p>One category below the aeroplane RFFS category, or</p> <p>Two categories below the aeroplane RFFS category, in the case of a temporary downgrade of 72 hours or less</p> <p>but not lower than aerodrome RFFS Category 4 for aeroplanes with maximum certificated take-off mass of over 27000 kg and not lower than Category 1 for other aeroplanes.</p>

3.1.1.3 So as to comply with the operational regulations applicable to a given flight, the operator selects alternate aerodrome(s) for various uses. During flight planning, the acceptable aerodrome RFFS category at a selected alternate aerodrome may equal or exceed the values in Table 2.

Table 2

Acceptable aerodrome category for rescue and firefighting (alternate aerodromes)

<p>Aerodromes (Required to be specified in the operational flight plan)</p> <p><i>Note: If an individual aerodrome serves more than one purpose, the highest required category corresponding to that purpose at the time of expected use applies.</i></p>	<p>Acceptable aerodrome RFFS protection level (Based on published aerodrome RFFS category, including any modification by NOTAM)</p>
<p>Take-off alternate and destination alternate aerodromes</p>	<p>Where a suitable risk assessment has been conducted by the operator:</p> <p>Two categories below the aeroplane RFFS category, or</p> <p>Three categories below the aeroplane RFFS category in the case of a temporary downgrade of 72 hours or less</p>



	<p>but not lower than aerodrome RFFS Category 4 for aeroplanes with maximum certificated take-off mass of over 27000 kg and not lower than Category 1 for other aeroplanes.</p>
<p>En-route alternate aerodromes</p>	<ul style="list-style-type: none"> • If at least 30 minutes notice is given to the aerodrome operator prior to the arrival of the aeroplane, a minimum of RFFS Category 4 for aeroplanes with maximum certificated take-off mass of over 27000 kg, and RFFS Category 1 for other aeroplanes. • If less than 30 minutes notice can be given to the aerodrome operator prior to the arrival of the aeroplane: <ul style="list-style-type: none"> - Two categories below the aeroplane RFFS category; or - Three categories below the aeroplane RFFS category in the case of a temporary downgrade of 72 hours or less. <p>but not lower than aerodrome RFFS Category 4 for aeroplanes with maximum certificated take-off mass of over 27000 kg and not lower than Category 1 for other aeroplanes.</p>

3.1.2 For all-cargo operations, further reductions might be acceptable provided that the RFFS capability is adequate to arrest fire around the flight deck area long enough for the persons on board to safely evacuate the aeroplane.

3.1.3 Variations

3.1.3.1 Notwithstanding the guidance developed in 3.1.1, an aerodrome RFFS category below the protection levels defined in Tables 1 and 2 may be acceptable if other considerations prevail, such as weather conditions, runway(s) characteristics, or length of diversion. Such variation should be based on a specific risk assessment conducted by the operator as part of its safety management system.

3.1.3.2 Variations to the aerodrome RFFS category may concern, amongst other cases:

- a. an occasional flight; or
- b. temporary downgrades exceeding 72 hours.

Where applicable, a variation may be used for a group of aerodromes selected for the same purpose, for a given aeroplane type.

3.1.3.3 The aforementioned variations may be based on additional or other criteria relevant to the type of operations. For instance, the 72-hour threshold for RFFS temporary downgrades may not be relevant for a single flight to or from the aerodrome concerned, such as a non-scheduled flight, whereas it is fully relevant for operations carried out on a continuous and daily basis. A variation may be time limited. A variation may also be modified to reflect the changes of the RFFS protection level available at the aerodrome(s) concerned. The variations and their validity period should be included in the operations manual.

3.1.3.4 For variations to the acceptable RFFS category at departure and destination aerodromes, the aeroplane operator’s specific safety risk assessment for an aerodrome intended to be used as a departure or destination aerodrome may be based on the following elements:

- a. the frequency of flights intended by the aeroplane operator in relation to a lowered aerodrome RFFS category;



- b. coordination between the aeroplane operator and the aerodrome operator (for instance, reducing intervention time by prepositioning the existing RFFS means along the runway before the intended take-off or landing).
- 3.1.3.5 For regular flights, the coordination should take into account the principles of ICAO Annex 14, Volume I, Chapter 9, 9.2.5 and 9.2.6 which are applicable to the aerodrome operator, as well as the possibilities to modulate the aerodrome RFFS category available on a daily cycle or seasonal cycle.
- 3.1.3.6 For variations in acceptable RFFS for an alternate aerodrome, the aeroplane operator's specific safety risk assessment for an aerodrome selected as a take-off alternate aerodrome, a destination alternate aerodrome or an en-route alternate aerodrome may be based on the following elements:
- a. the probability of effective use of the aerodrome concerned; and
 - b. the frequency of selection of the aerodrome for the respective purpose of use.
- 3.2 In flight
- 3.2.1 The information contained in the operations manual about the aerodrome RFFS category acceptable at the planning stage (including Tables 1 and 2 above and, where usable, the variations under the specifications in sub-paragraph 3.1.3) is applicable at the in-flight re-planning point.
- 3.2.2 In flight, the commander may decide to land at an aerodrome regardless of the RFFS category if, in the pilot's judgement after due consideration of all prevailing circumstances, to do so would be safer than to divert.

AMC OPS 1.065

Carriage of Weapons of War and Munitions of War

See OPS 1.065

1. There is no internationally agreed definition of weapons of war and munitions of war. Some States may have defined them for their particular purposes or for national need.
2. It should be the responsibility of the operator to check, with the State(s) concerned, whether or not a particular weapon or munitions is regarded as a weapon of war or munitions of war. In this context, States which may be concerned with granting approvals for the carriage of weapons of war or munitions of war are those of origin, transit, over flight and destination of the consignment and the State of the Operator.
3. Where weapons of war or munitions of war are also dangerous goods by definition (e.g. torpedoes, bombs, etc.), Subpart R will also apply. (See also AMC OPS 1.070.)

AMC OPS 1.070

Carriage of Sporting Weapons

See OPS 1.070

1. There is no internationally agreed definition of sporting weapons. In general they may be any weapon which is not a weapon of war or munitions of war (See AMC OPS 1.065). Sporting weapons include hunting knives, bows and other similar articles. An antique weapon, which at one time may have been a weapon of war or munitions of war, such as a musket, may now be regarded as a sporting weapon.
2. A firearm is any gun, rifle or pistol which fires a projectile.
3. In the absence of a specific definition, for the purpose of OPS and in order to provide some guidance to operators, the following firearms are generally regarded as being sporting weapons:
 - a. Those designed for shooting game, birds and other animals;
 - b. Those used for target shooting, clay-pigeon shooting and competition shooting, providing the weapons are not those on standard issue to military forces;
 - c. Airguns, dart guns, starting pistols, etc.
4. A firearm, which is not a weapon of war or munitions of war, should be treated as a sporting weapon for the purposes of its carriage on an aeroplane.



5. Other procedures for the carriage of sporting weapons may need to be considered if the aeroplane does not have a separate compartment in which the weapons can be stowed. These procedures should take into account the nature of the flight, its origin and destination, and the possibility of unlawful interference. As far as possible, the weapons should be stowed so they are not immediately accessible to the passengers (e.g. in locked boxes, in checked baggage which is stowed under other baggage or under fixed netting). If procedures other than those in OPS 1.070(b)(1) are applied, the commander should be notified accordingly.

AC OPS 1.085(e)(3)
Crew Responsibilities
See OPS 1.085(e)(3)

Information on the effects of medication, drugs, other treatments and alcohol, is to be found in ICAO or EASA Manual of Aviation Medicine, CAR MED 3.040 or at the authorised Aviation Medical Centre.

AC OPS 1.085(f)(9)
Sterile Flight Crew Compartment

Those procedures and instructions shall not require crew members to perform any activities during critical phases of flight other than those required for the safe operation of the aircraft. Procedures and instructions for a sterile flight crew compartment shall also be included.

- a. Sterile flight crew compartment procedures should ensure that:
 1. flight crew activities are restricted to essential operational activities; and
 2. cabin crew and technical crew communications to flight crew or entry into the flight crew compartment are restricted to safety or security matters.
- b. The sterile flight crew compartment procedures should be applied:
 1. during critical phases of flight; that is;
 - i) during taxiing; and
 - ii) below 10000 feet above the aerodrome of departure after take-off and the aerodrome of destination before landing, except for cruise flight; and
 2. during any other phases of flight as determined by the commander.
- c. All crew members should be trained on sterile flight crew compartment procedures established by the operator, as appropriate to their duties.
- d. permitted occupants of the flight crew compartment must be briefed on sterile flight crew compartment procedures.

AC OPS 1.125
Documents to be Carried
See OPS 1.125

The Certificates may be presented in digital format. The certificates, when issued by the Authority, are rendered valid as the original documents in their digital form. They satisfy the on-board carriage requirements for aircraft engaged in international air navigation in accordance with Articles 29 and 31 of the Convention on International Civil Aviation as well as the requirements of Annex 7 and 8 to the same Convention.

The procedures for the carriage of an electronic version of the documents listed in OPS 1.125(a) must be acceptable to the Authority.

AMC OPS 1.130
Manuals to be Carried
See OPS 1.130 (a) (1)

The carriage of an approved electronic version of the Operations Manual is acceptable.



AC OPS 1.160(a)(1) and (2)
Preservation of Recordings
See OPS 1.060(a)(1) and (2)

In OPS 1.160(a)(1) and (2), the phrase 'to the extent possible' means that either :

1. There may be technical reasons why all of the data cannot be preserved; or
2. The aeroplane may have been dispatched with unserviceable recording equipment as permitted by the MEL Policy.

AC OPS 1.165(c)(2)
Leasing of Aeroplanes Between a San Marino Operator and any Entity
See OPS 1.165(c)(2)

1. *Reserved*
2. The Authority may approve San Marino operators provided that:
 - a. The lessor is the operator holding an AOC issued by a State which is a signatory to the Convention on International Civil Aviation; and
 - b. Unless otherwise agreed by the Authority of the lessee, the lessee audits the operation of the lessor to confirm compliance with operating and aircrew training standards equivalent to OPS 1, maintenance standards and aircraft certification standards as prescribed by the Certifying State; and
 - c. The routes intended to be flown are contained within the authorised areas of operations specified in the AOC of the lessor; and
 - d. (Reserved)
 - e. For the duration of the lease, the flight and duty time limitations and rest requirements used by the lessor are not more permissive than apply in OPS 1.
3. Lessors, when first approved by the Authority, and any revalidations, remain valid for a period not exceeding 12 months.

Note: The lessee is responsible for providing information to the Authority to support the initial application and any revalidations.



**Appendix to AC OPS 1.037 (d)
Flight Data Monitoring Programme**

The following table provides examples of FDM events that may be further developed using operator- and aeroplane-specific limits. The table is considered illustrative and not exhaustive.

Event Group	Description
Rejected Take-off	High Speed Rejected Take-off
Take-off Pitch	Pitch rate high on Take-off Pitch attitude high during Take-off
Unstick Speeds	Unstick speed high Unstick speed low
Height Loss in Climb-out	Initial climb height loss 20 ft AGL to 400 ft AAL Initial climb height loss 400 ft to 1500 ft AAL
Slow Climb-out	Excessive time to 1000 ft AAL after Take-off
Climb-out Speeds	Climb out speed high below 400 ft AAL Climb out speed high 400 ft AAL to 1000 ft AAL Climb out speed low 35 ft AGL to 400 ft AAL Climb out speed low 400 ft AAL to 1500 ft AAL
High Rate of Descent	High rate of descent below 2000 ft AGL
Go-around	Go-around below 1000 ft AAL Go-around above 1000 ft AAL
Low Approach	Low on approach
Glideslope	Deviation under glideslope Deviation above glideslope (below 600 ft AGL)
Approach Power	Low power on approach
Approach Speeds	Approach speed high within 90 sec of touchdown Approach speed high below 500 ft AAL Approach speed high below 50 ft AGL Approach speed low within 2 minutes of touchdown
Landing Flap	Late land flap (not in position below 500 ft AAL) Reduced flap landing Flap load relief system operation
Landing Pitch	Pitch attitude high on landing Pitch attitude low on landing
Bank Angles	Excessive bank below 100 ft AGL Excessive bank 100 ft AGL to 500 ft AAL Excessive bank above 500 ft AGL Excessive bank near ground (below 20 ft AGL)
Normal Acceleration	High normal acceleration on ground High normal acceleration in flight flaps up (+/- increment) High normal acceleration in flight flaps down(+/- increment) High normal acceleration at landing
Abnormal Configuration	Take-off configuration warning Early configuration change after Take-off (flap) Speed brake with flap Speedbrake on approach below 800 ft AAL Speedbrake not armed below 800 ft AAL
Ground Proximity Warning	GPWS operation - hard warning GPWS operation - soft warning GPWS operation - windshear warning GPWS operation - false warning
TCAS Warning	TCAS operation – Resolution Advisory
Margin to Stall/Buffer	Stickshake False stickshake Reduced lift margin except near ground Reduced lift margin at Take-off Low buffet margin (above 20000 ft)
Flight Manual Limitations	Vmo Exceedance Mmo Exceedance Flap placard speed Exceedance Gear down speed Exceedance Gear selection up/down speed Exceedance Flap/ Slat altitude Exceedance Maximum operating altitude Exceedance



This Page Intentionally Left Blank

**AC/AMC C****OPERATOR CERTIFICATION & SUPERVISION****AMC OPS 1.175****The Management Organisation of an AOC Holder****See OPS 1.175(g)-(o)**

1. Function and Purpose
 - 1.1 The safe conduct of air operations is achieved by the operator and an Authority working in harmony towards a common aim. The functions of the two bodies are different, well defined, but complementary. In essence, the operator complies with the standards set through putting in place a sound and competent management structure. The Authority working within a framework of law (statutes), sets and monitors the standards expected from operators.
2. Responsibilities of Management
 - 2.1 The responsibilities of management related to OPS 1 should include at least the following five main functions:
 - a. Determination of the operator's flight safety policy;
 - b. Allocation of responsibilities and duties and issuing instructions to individuals, sufficient for implementation of company policy and the maintenance of safety standards;
 - c. Monitoring of flight safety standards;
 - d. Recording and analysis of any deviations from company standards and ensuring corrective action;
 - e. Evaluating the safety record of the company in order to avoid the development of undesirable trends.

AMC OPS 1.175(c)(1)**Principal Place of Business****See OPS 1.175(c)(1)**

1. OPS 1.175(c)(1) requires the operator to have his principal place of business located in San Marino.
2. If maintenance, continuing airworthiness functions or operational control is outsourced, the registered office in San Marino must demonstrate, to the Authority, the ability to ensure regulatory compliance.

AC OPS 1.175(h)**Accountable Manager****See OPS 1.175(h)**

The Accountable Manager is the person acceptable to the Authority who has corporate authority for ensuring that all operations and maintenance activities can be financed and carried out to the standard required by the Authority, and any additional requirements defined by the operator. The Accountable Manager's responsibilities include:

1. being the single, identifiable person having responsibility for the effective and efficient performance of the organisation including the Safety Management System (SMS).
2. having direct responsibility for the conduct of the organisation's affairs.
3. ensuring that all necessary resources are available to accomplish the standards defined in the CAA requirements and the organisation's approved manuals.
4. having ultimate responsibility for operational standards and compliance with the relevant regulations
5. having full authority for financial matters.
6. having full authority for human resources.
7. having final responsibility for all safety and quality functions and standards.
8. establishing and promote the safety and quality policy specified in the applicable regulations.
9. demonstrating a basic understanding of the regulations applicable to the CAA approval granted.

**AC OPS 1.175(i)****Nominated Postholders – Competence****See OPS 1.175(i)**

1. General. Nominated Postholders should, in the normal way, be expected to satisfy the Authority that they possess the appropriate experience and licensing requirements which are listed in paragraphs 2 to 6 below. In particular cases, and exceptionally, the Authority may accept a nomination which does not meet the requirements in full but, in this circumstance, the nominee should be able to demonstrate experience which the Authority will accept as being comparable and also the ability to perform effectively the functions associated with the post and with the scale of the operation.

Note: Refer also to CAP 11.

2. Nominated postholders should have:
 - 2.1 Practical experience and expertise in the application of aviation safety standards and safe operating practices;
 - 2.2 Comprehensive knowledge of:
 - a. OPS 1 and any associated requirements and procedures;
 - b. The AOC holder's Operations Specifications;
 - c. The need for, and content of, the relevant parts of the AOC holder's Operations Manual;
 - 2.3 Familiarity with Quality Systems;
 - 2.4 Appropriate management experience in a comparable organisation; and
 - 2.5 Five years relevant work experience of which at least two years should be from the aeronautical industry in an appropriate position.
3. Flight Operations. The nominated postholder or his deputy should hold a valid Flight Crew Licence appropriate to the type of operation conducted under the AOC in accordance with the following:
 - 3.1 If the AOC includes aeroplanes certificated for a minimum crew of 2 pilots - An Airline Transport Pilot's Licence issued or validated by the Authority;
 - 3.2 If the AOC is limited to aeroplanes certificated for a minimum crew of 1 pilot - A Commercial Pilot's Licence, and if appropriate to the operation, an Instrument Rating issued or validated by the Authority.
4. Continuing Airworthiness. The nominated postholder should possess the following:
 - 4.1 Relevant engineering degree, or aircraft maintenance technician with additional education acceptable to the Authority. 'Relevant engineering degree' means an engineering degree from Aeronautical, Mechanical, Electrical, Electronic, Avionic or other studies relevant to the maintenance of aircraft/aircraft components.
 - 4.2 Thorough familiarity with the organisation's Maintenance Management Exposition.
 - 4.3 Knowledge of the relevant type(s) of aircraft.
 - 4.4 Knowledge of maintenance methods.
5. Crew Training. The nominated postholder or his deputy is expected to hold, or have held, a Type Rating Instructor rating (or acceptable equivalent instructional qualification).
 - 5.1 The nominated Postholder should have a thorough knowledge of the AOC holder's crew training concept for Flight Crew and for Cabin Crew when relevant.
6. Ground Operations. The nominated postholder should have a thorough knowledge of the AOC holder's ground operations concept.

AMC OPS 1.175(i)**Nominated Persons****See OPS 1.175(i)**

- a. The person may hold more than one of the nominated posts if such an arrangement is considered suitable and properly matched to the scale and scope of the operation.
- b. A description of the functions and the responsibilities of the nominated persons, including their names, should be contained in the operations manual.



- c. The holder of an AOC should make arrangements to ensure continuity of supervision in the absence of nominated persons and these arrangements must be in the Operations Manual.
- d. The person nominated by the holder of an AOC should not be nominated by another holder of an AOC, unless agreed with the competent authorities concerned.
- e. Persons nominated should be contracted to work sufficient hours to fulfil the management functions associated with the scale and scope of the operation.

AMC OPS 1.175(i)**Nominated Persons – Small Organisations****See OPS 1.175(i)**

The smallest organisation that can be considered is the one-man organisation where all of the nominated posts are filled by the accountable manager, and audits are conducted by an independent person.

AC OPS 1.175(l)**Combination of Nominated Postholder's Responsibilities****See OPS 1.175(l)**

1. The acceptability of a single person holding several posts, possibly in combination with being the Accountable Manager, should depend upon the nature and scale of the operation. The two main areas of concern are competence and an individual's capacity to meet his/her responsibilities.
2. As regards competence in the different areas of responsibility, there should not be any difference from the requirements applicable to persons holding only one post.
3. The capacity of an individual to meet his/her responsibilities will primarily be dependent upon the scale of the operation. However the complexity of the organisation or of the operation may prevent, or limit, combinations of posts which may be acceptable in other circumstances.
4. In most circumstances, the responsibilities of a nominated postholder will rest with a single individual. However, in the area of ground operations, it may be acceptable for these responsibilities to be split, provided that the responsibilities of each individual concerned are clearly defined.
5. The intent of OPS 1.175 is neither to prescribe any specific organisational hierarchy within the operator's organisation nor to prevent an Authority from requiring a certain hierarchy before it is satisfied that the management organisation is suitable.

AC OPS 1.175(j) & (k)**Employment of Staff****See OPS 1.175(j) & (k)**

In the context of OPS 1.175(j) & (k), the expression "full-time staff" means members of staff who are employed for not less than 35 hours per week excluding vacation periods. For the purpose of establishing the scale of operation, administrative staff, not directly involved in operations or maintenance, should be excluded.

AMC OPS 1.185(b)**Maintenance Management Exposition Details****See OPS 1.185(b)**

1. The organisation's Maintenance Management Exposition should reflect the details of any sub-contract(s).
2. A change of aeroplane type or of the approved maintenance organisation may require the submission of an acceptable amendment to the Maintenance Management Exposition.



This Page Intentionally Blank

**AC/AMC D****OPERATIONAL PROCEDURES****AC OPS 1.195****Operational Control****See OPS 1.195**

1. Operational control means the exercise by the operator, in the interest of safety, of responsibility for the initiation, continuation, termination or diversion of a flight. There may be a requirement for licensed flight dispatchers and a full flight watch system.
2. The organisation and methods established to exercise operational control should be included in the Operations Manual and should cover at least a description of responsibilities concerning the initiation, continuation, termination or diversion of each flight.

AMC to OPS 1.197**Aircraft Tracking**

Guidance on aircraft tracking capabilities is contained in the Normal Aircraft Tracking Implementation Guidelines (Cir 347).

Note 1: Oceanic area, for the purpose of aircraft tracking, is the airspace which overlies waters outside the territory of a State.

Note 2: Operational procedures for monitoring the aircraft tracking information are contained in PANS-OPS, Volume III, Section 10.

AC OPS 1.205**Competence of Operations Personnel****See OPS 1.205**

If the operator employs Flight Operations Officers in conjunction with a method of Operational Control as defined in OPS 1.195, training for these personnel should be based on relevant parts of ICAO Doc 7192 D3. This training should be described in Subpart D of the Operations Manual. It is not to be inferred from this that there is a requirement for Licensed Flight Dispatchers or for a flight following system

AMC OPS 1.210(a)**Establishment of Procedures****See OPS 1.210(a)**

1. The operator should specify the contents of safety briefings for all cabin crew members prior to the commencement of a flight or series of flights.
2. The operator should specify procedures to be followed by cabin crew with respect to:
 - a. Arming and disarming of slides;
 - b. The operation of cabin lights, including emergency lighting;
 - c. The prevention and detection of cabin, oven and toilet fires;
 - d. Action to be taken when turbulence is encountered; and
 - e. Actions to be taken in the event of an emergency and/or an evacuation.

AMC OPS 1.210(b)**Establishment of Procedures****See OPS 1.210(b)**

When the operator establishes procedures and a checklist system for use by cabin crew with respect to the aeroplane cabin, at least the following items should be taken into account:



ITEM	PRE-TAKE-OFF	IN-FLIGHT	PRE-LANDING	POST-LANDING
1. Brief of cabin crew by the senior cabin crew member prior to commencement of a flight or series of flights.	X			
2. Check of safety equipment in accordance with operator's policies and procedures.	X			
3. Security checks as required by Subpart S (OPS 1.1250).	X			X
4. Supervision of passenger embarkation and disembarkation (OPS 1.075; OPS 1.105; OPS 1.270; OPS 1.280; OPS 1.305).	X			X
5. Securing of passenger cabin (e.g. seat belts, cabin cargo/baggage etc.(OPS 1.280; OPS 1.285; OPS 1.310).	X		X	
6. Securing of galleys and stowage of equipment (OPS 1.325).	X		X	
7. Arming of door slides.	X		X	
8. Safety information to passengers (OPS 1.285).	X	X	X	X
9. 'Cabin secure' report to flight crew.	X	if required	X	
10. Operation of cabin lights.	X	if required	X	
11. Cabin crew at crew stations for Take-off and landing.(OPS 1.310, OPS 1.210(c)/AMC OPS 1.210(c)).	X		X	X
12. Surveillance of passenger cabin.	X	X	X	X
13. Prevention and detection of fire in the cabin (including the combi-cargo area), crew rest areas, galleys and toilets and instructions for actions to be taken.	X	X	X	X
14. Action to be taken when turbulence is encountered or in-flight incidents (pressurisation failure, medical emergency etc.). (See also OPS 1.320 and OPS 1.325).		X		
15. Disarming of door slides.				X
16. Reporting of any deficiency and/or unserviceability of equipment and/or any incident (See also OPS 1.420).	X	X	X	X

AC OPS 1.216
In-flight Operational Instructions
 See OPS 1.216

When co-ordination with an appropriate Air Traffic Service unit has not been possible, in-flight operational instructions do not relieve a commander of responsibility for obtaining an appropriate clearance from an Air Traffic Service unit, if applicable, before making a change in flight plan.

AC OPS 1.235
Noise Abatement Departure Procedures (NADP)
 See OPS 1.235

OPS 1.235 deals only with the vertical profile of the departure procedure. Lateral track has to comply with the SID.

“Climb profile” in OPS 1.235(c) means the vertical path of the NADP as it results from the pilot’s actions (Engine power reduction, acceleration, slats/flaps retraction).

“Sequence of actions” means the order and the timing in which these pilot’s actions are carried out.

Example: for a given aeroplane type when establishing the Distant NADP, the operator should choose either to reduce power first and then accelerate or to accelerate first and then wait until slats/flaps are retracted before reducing power. The two methods constitute two different sequences of actions within the meaning of this AC.

For an aeroplane type, each of the two departure climb profiles should be defined by:

- one sequence of actions (one for close-in, one for distant).
- two AAL altitudes (heights):
 - the altitude of the first pilot’s action (generally power reduction with or without acceleration). This altitude should not be less than 800ft AAL.
 - the altitude of the end of the noise abatement procedure. This altitude should usually not be more than 3000ft AAL.



These two altitudes may be runway-specific when the aeroplane FMS has the relevant function which permits the crew to change thrust reduction and/or acceleration altitude/height. If the aeroplane is not FMS-equipped or the FMS is not fitted with the relevant function, two fixed heights should be defined and used for each of the two NADPs.

AC OPS 1.243

Operations in Areas with Specified Navigation Performance Requirements

See OPS 1.243

1. The equipment carriage requirements, operational and contingency procedures and operator approval requirements relating to areas, portions of airspace or on routes where navigation performance specifications have so far been specified can be found in the following documentation:
 - a. For the North Atlantic NAT HLA - ICAO document Doc 7030/4 Regional Supplementary Procedures (NAT Supps) & NAT Doc 007)
 - b. For RVSM in the North Atlantic and Europe (ECAC States) - Doc 7030/4 (NAT and EUR Supps)
 - c. For General Guidance on Performance Based Navigation Manual - ICAO Doc 9613
 - d. For European RNAV (ECAC States) - Doc 7030/4 (EUR Supps)
 - e. JAA TGL 2 (Note this is now in the GAI 20 Series as AMC 20-4) – B-RNAV (ECAC States)
 - f. JAA TGL 10 – P-RNAV (ECAC States)
 - g. JAA GAI 20 - AMJ 20X9 "Recognition of FAA Order 8400.12A for RNP 10 Operations"
 - h. Eurocontrol Standard Document 009-93 (RNAV Operations)
2. Operators should be aware that requirements relating to performance-based navigation, including Area Navigation (RNAV) and Required Navigation Performance (RNP), are currently under rapid development. Pending the development, appropriate guidance and approval material or available material published by other than ICAO or EASA may be used in order to approve operators for operations in airspace that has specified navigation performance requirements.

AMC OPS 1.245(a)

Maximum Distance from an Adequate Aerodrome for Two-engine Aeroplanes without EDTO Approval

See OPS 1.245

Notes:

1. *MAPSC - Maximum Approved Passenger Seating Configuration*
2. *MTOM - Maximum Take-off Mass*
3. *The OEI cruising speed is intended to be used solely for establishing the maximum distance from an adequate aerodrome.*

AMC OPS 1.245(a)(2)(ii)

Operation of Non-EDTO Approved Twin Turbojet Aeroplanes between 120 and 180 Minutes from an Adequate Aerodrome

See OPS 1.245(a)(2)(ii)

1. As prescribed in OPS 1.245(a)(2), the operator may not operate a twin turbo-jet powered aeroplane having a maximum approved passenger seating configuration of 19 or less beyond 120 minutes from an adequate aerodrome at the one-engine-inoperative cruise speed calculated in accordance with OPS 1.245(b) unless specifically approved by the Authority. This 120 minute threshold may be exceeded by no more than 60 minutes. In order for operations between 120 and 180 minutes to be approved, due account should be taken of the aeroplane's design and capabilities (as outlined below) and the operator's experience related to such operations. The operator must ensure that the following items are addressed and information must be included in the Operations Manual and the operator's Maintenance Management Exposition.



Note: Mention of “the aeroplane’s design” in paragraph 1 above does not imply any additional Type Design Approval requirements (beyond the applicable original Type Certification requirements) before the Authority will permit operations beyond the 120 minute threshold.

2. Systems capability - Aeroplanes should be certificated to EASA CS-25 as appropriate (or equivalent). With respect to the capability of the aeroplane systems, the objective is that the aeroplane is capable of a safe diversion from the maximum diversion distance with particular emphasis on operations with one-engine-inoperative or with degraded system capability. To this end, the operator should give consideration to the capability of the following systems to support such a diversion:

a. Propulsion systems - The aeroplane power plant should meet the applicable requirements prescribed in EASA CS 25 and EASA CS E or equivalents, concerning engine type certification, installation and system operation. In addition to the performance standards established by the Authority at the time of engine certification, the engines should comply with all subsequent mandatory safety standards specified by the Authority, including those necessary to maintain an acceptable level of reliability.

In addition, consideration should be given to the effects of extended duration single-engine operation (e.g. the effects of higher power demands such as bleed and electrical).

b. Airframe systems - With respect to electrical power, three or more reliable (as defined by FAR 25/EASA CS-25 or equivalent) and independent electrical power sources should be available, each of which should be capable of providing power for all essential services (See paragraph 8 below). For single-engine operations, the remaining power (electrical, hydraulic, pneumatic) should continue to be available at levels necessary to permit continued safe flight and landing, and to provide those services necessary for the overall safety of the passengers and crew. As a minimum, following the failure of any two of the three electrical power sources, the remaining source should be capable of providing power for all of the items necessary for the duration of any diversion. If one or more of the required electrical power sources are provided by an APU, hydraulic system or Air Driven Generator/Ram Air Turbine (ADG/RAT), the following criteria should apply as appropriate:

- i. To ensure hydraulic power (Hydraulic Motor Generator) reliability, it may be necessary to provide two or more independent energy sources.
- ii. The ADG/RAT, if fitted, should not require engine dependent power for deployment.
- iii. The APU should meet the criteria in sub-paragraph c below.

c. APU - The APU, if required for extended range operations, should be Certificated as an essential APU and should meet the applicable FAR 25/EASA CS 25 provisions or equivalent.

d. Fuel supply system - Consideration should include the capability of the fuel supply system to provide sufficient fuel for the entire diversion taking account of aspects such as fuel boost and fuel transfer.

3. Powerplant Events and corrective action.

a. All powerplant events and operating hours should be reported by the operator to the Airframe and Engine manufacturers as well as to the Authority in the State of the Operator.

b. These events should be evaluated by the operator in consultation with his Authority and with the engine and airframe manufacturers. The Authority may consult with the type design authority to ensure that world wide data is evaluated.

c. Where statistical assessment alone may not be applicable e.g. where the fleet size or accumulated flight hours are small, individual powerplant events should be reviewed on a case by case basis.

d. The evaluation or statistical assessment, when available, may result in corrective action or the application of operational restrictions.

Note: Powerplant events could include engine shut downs, both on ground and in-flight, (excluding normal training events) including flameout, occurrences where the intended thrust level was not achieved or where crew action was taken to reduce thrust below the normal level for whatever reason, and unscheduled removals.



4. Maintenance: The operator's maintenance requirements should address the following:
 - a. Release to service - A pre-departure check, additional to the pre-flight inspection required by OPS 1.890(a)(1) should be reflected in the operator's Maintenance Management Exposition. These checks should be conducted and certified by an organisation appropriately approved/accepted in accordance with CAR 145 or by an appropriately trained flight crew member prior to an extended range flight to ensure that all maintenance actions are complete and all fluid levels are at prescribed levels for the flight duration.
 - b. Engine oil consumption programmes - Such programmes are intended to support engine condition trend monitoring (see below).
 - c. Engine condition trend monitoring programme - A programme for each powerplant that monitors engine performance parameters and trends of degradation that provides for maintenance actions to be undertaken prior to significant performance loss or mechanical failure.
 - d. Arrangements to ensure that all corrective actions required by the type design authority are implemented.
5. Flight Crew Training: Flight crew training for this type of operation should include, in addition to the requirements of OPS 1 Subpart N, particular emphasis on the following:
 - a. Fuel management - Verifying required fuel on board prior to departure and monitoring fuel on board en-route including calculation of fuel remaining. Procedures should provide for an independent cross-check of fuel quantity indicators (e.g. fuel flow used to calculate fuel burned compared to indicated fuel remaining). Confirmation that the fuel remaining is sufficient to satisfy the critical fuel reserves.
 - b. Procedures for single and multiple failures in flight that may give rise to go/no-go and diversion decisions - Policy and guidelines to aid the flight crew in the diversion decision making process and the need for constant awareness of the closest suitable alternate aerodrome in terms of time.
 - c. One-engine-inoperative performance data - Drift down procedures and one-engine-inoperative service ceiling data.
 - d. Weather reports and flight requirements - METAR and TAF reports and obtaining in flight weather updates on en-route alternate, destination and destination alternate aerodromes. Consideration should also be given to forecast winds (including the accuracy of the forecast compared to actual wind experienced during flight) and meteorological conditions along the expected flight path at the one-engine-inoperative cruising altitude and throughout the approach and landing.
 - e. Pre-departure check - Flight crew members who are responsible for the pre-departure check of an aeroplane (see paragraph 3.a above), should be fully trained and competent to carry out the check. The training programme required, which should be approved by the Authority, should cover all relevant maintenance actions with particular emphasis on checking required fluid levels.
6. MEL - The MEL should take into account all items specified by the manufacturer relevant to operations in accordance with this AMC.
7. Dispatch/Flight Planning Requirements: The operator's dispatch should address the following:
 - a. Fuel and oil supply - An aeroplane should not be dispatched on an extended range flight unless it carries sufficient fuel and oil to comply with the applicable operational requirements and any additional reserves determined in accordance with sub-paragraphs (a)(i) (ii) and (iii) below.
 - (i) Critical fuel scenario - The critical point is the furthest point from an alternate aerodrome assuming a simultaneous failure of an engine and the pressurisation system. For those aeroplanes that are type certificated to operate above Flight Level 450, the critical point is the furthest point from an alternate aerodrome assuming an engine failure. the operator should carry additional fuel for the worst-case fuel burn condition (one engine versus two engines operating), if this is greater than the additional fuel calculated in accordance with Appendix 1 to OPS 1.255(a)(6), as follows:
 - A. Fly from the critical point to an alternate aerodrome:
 - At 10,000ft; or



- At 25,000ft or the single-engine ceiling, whichever is lower, provided that all occupants can be supplied with and use supplemental oxygen for the time required to fly from the critical point to an alternate aerodrome; or
 - At the single-engine ceiling, provided that the aeroplane is type certificated to operate above Flight Level 450.
- B. Descend and hold at 1,500 feet for 15 minutes in ISA conditions;
- C. Descend to the applicable MDA/DH followed by a missed approach (taking into account the complete missed approach procedure); followed by
- D. A normal approach and landing.
- (ii) Ice protection - Additional fuel used when operating in icing conditions (e.g. operation of ice protection systems (engine/airframe as applicable)) and, when manufacturer's data is available, take account of ice accumulation on unprotected surfaces if icing conditions are likely to be encountered during a diversion;
- (iii) APU operation - If an APU has to be used to provide additional electrical power, consideration should be given to the additional fuel required.
- b. Communication facilities - The availability of communications facilities in order to allow reliable two-way voice communications between the aeroplane and the appropriate air traffic control unit at one-engine-inoperative cruise altitudes.
- c. Aircraft Technical Log review to ensure proper MEL procedures, deferred items, and required maintenance checks completed.
- d. En-route alternate aerodrome(s) - Ensuring that en-route alternate aerodromes are available for the intended route, within 180 minutes based upon the one-engine-inoperative cruise speed which is a speed within the certificated limits of the aeroplane, selected by the operator and approved by the Authority, and confirmation that, based on the available meteorological information, the weather conditions at en-route alternate aerodromes are at or above the applicable minima for the period of time during which the aerodrome(s) may be used. (See also OPS 1.297).

Planning minima			
Type of Approach	Planning Minima (RVR visibility required & ceiling if applicable)		
	Aerodrome with		
	at least 2 separate approach procedures based on 2 separate aids serving 2 separate runways (see AMC OPS 1.295 (c)(1)(ii))	at least 2 separate approach procedures based on 2 separate aids serving 1 runway	or at least 1 approach procedure based on 1 aid serving 1 runway
Precision Approach Cat II, III (ILS, MLS)	Precision Approach Cat I Minima	Non-Precision Approach Minima	
Precision Approach Cat I (ILS, MLS)	Non-Precision Approach Minima	Circling minima or, if not available, non-precision approach minima plus 200 ft / 1 000 m	
Non-Precision Approach	The lower of non-precision approach minima plus 200 ft / 1 000 m or circling minima	The higher of circling minima or non-precision approach minima plus 200 ft / 1 000 m	
Circling Approach	Circling minima		

8. Power Supply to Essential Services: Any one of the three electrical power sources referred to in subparagraph 2.b above should be capable of providing power for essential services which should normally include:
- a. Sufficient instruments for the flight crew providing, as a minimum, attitude, heading, airspeed and altitude information;
 - b. Appropriate pitot heating;
 - c. Adequate navigation capability;
 - d. Adequate radio communication and intercommunication capability;
 - e. Adequate flight deck and instrument lighting and emergency lighting;
 - f. Adequate flight controls;
 - g. Adequate engine controls and restart capability with critical type fuel (from the stand-point of flame-out and restart capability) and with the aeroplane initially at the maximum relight altitude;



- h. Adequate engine instrumentation;
- i. Adequate fuel supply system capability including such fuel boost and fuel transfer functions that may be necessary for extended duration single or dual engine operation;
- j. Such warnings, cautions and indications as are required for continued safe flight and landing;
- k. Fire protection (engines and APU);
- l. Adequate ice protection including windshield de-icing; and
- m. Adequate control of the flight deck and cabin environment including heating and pressurisation.

The equipment (including avionics) necessary for extended diversion times should have the ability to operate acceptably following failures in the cooling system or electrical power systems.

AMC OPS 1.245(d)(1)

Operations by aeroplanes with turbine engines beyond 60 minutes to an en-route alternate aerodrome
 See OPS 1.245(d)(1)

- 1. Additional provisions for operations by aeroplanes with turbine engines beyond 60 minutes to an en-route alternate aerodrome also apply to non-extended diversion time operations. The following figure illustrates generically the integration of operations beyond 60 minutes to an en-route alternate aerodrome as well as defining the difference between non-EDTO and EDTO.

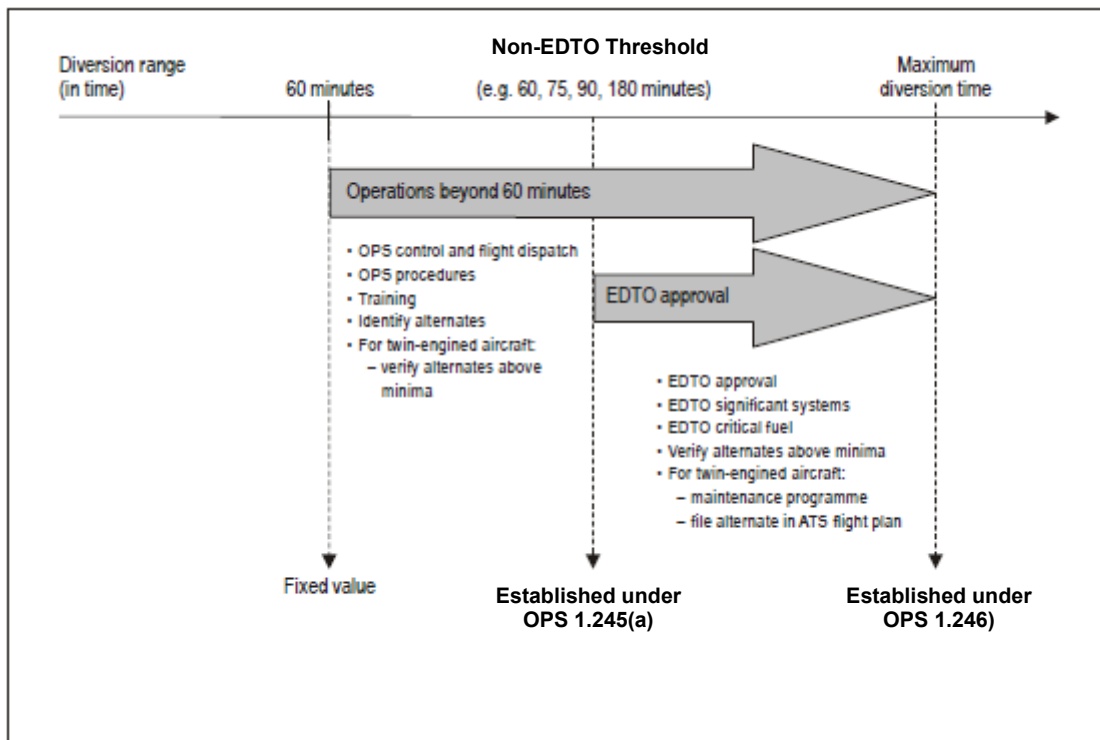

Generic Non EDTO & EDTO graphical representation

- 2. In applying the requirements for aeroplanes with turbine engines, it should be understood that:
 - a. operational control refers to the exercise, by the operator, of responsibility for the initiation, continuation, termination or diversion of a flight;
 - b. flight dispatch procedures refer to the method of control and supervision of flight operations. This does not imply a specific requirement for licensed flight dispatchers or a full flight following system;
 - c. operating procedures refer to the specification of organization and methods established to exercise operational control and flight dispatch procedures in the appropriate manual(s) and should cover at least a description of responsibilities concerning the initiation, continuation, termination or diversion of each flight as well as the method of control and supervision of flight operations; and



d. training programme refers to the training for pilots and flight operations officers/flight dispatchers in operations covered by this and following sections.

3. Aeroplanes with turbine engines operating beyond 60 minutes to an en-route alternate aerodrome are not required to have specific additional approval by the authority, except if they engage in extended diversion time operations.

4. Training

Training programmes should ensure area, route and aerodrome qualifications are complied with such as, but not limited to, route qualification, flight preparation, concept of extended diversion time operations and criteria for diversions.

5. Flight dispatch and operational requirements

In applying the general flight dispatch requirements particular attention should be paid to the conditions which might prevail any time that the operation is beyond 60 minutes to an en-route alternate aerodrome, e.g. systems degradation, reduced flight altitude, etc. At least the following aspects should be considered:

- a. identify en-route alternate airports;
- b. ensure that prior to departure the flight crew is provided with the most up-to-date information on the identified en-route alternate aerodromes, including operational status and meteorological conditions and, in flight, make available means for the flight crew to obtain the most up-to-date weather information;
- c. methods to enable two-way communications between the aeroplane and the operator's operational control centre;
- d. ensure that the operator has a means to monitor conditions along the planned route including the identified alternate airports and ensure that procedures are in place so that the flight crew are advised of any situation that may affect the safety of flight;
- e. ensure that the intended route does not exceed the established aeroplane threshold time unless the operator is approved for EDTO operations;
- f. pre-flight system serviceability including the status of items in the minimum equipment list;
- g. communication and navigation facilities and capabilities;
- h. fuel requirements; and
- i. availability of relevant performance information for the identified en-route alternate aerodrome(s).

6. In addition, operations conducted by aeroplanes with two turbine engines require that, prior to departure and in flight, the meteorological conditions at identified en-route alternate aerodromes will be at or above the aerodrome operating minima required for the operation during the estimated time of use.

7. En-route alternate aerodromes

Aerodrome(s) to which an aircraft may proceed in the event that a diversion becomes necessary while en route, where the necessary services and facilities are available, where aircraft performance requirements can be met, and which are expected to be operational if required, need to be identified any time that the operation is beyond 60 minutes to an en-route alternate aerodrome.

Note: En-route alternate aerodromes may also be the take-off and/or destination aerodromes.

AMC OPS 1.246
Extended Diversion Time Operations
(See OPS 1.246)

1. **Extended Diversion Time Operations - General**



- 1.1 This guidance material is organised to address operations beyond the stated threshold times of OPS 1.245 to an en-route alternate aerodrome for all aeroplanes with turbine engines. All extended diversion time operations require Authority approval. It should be understood that the threshold time established in accordance with OPS 1.245 is not an operating limit. It is a flight time to an en-route alternate aerodrome, which is established by the Authority as being the EDTO threshold beyond which particular consideration should be given to the aeroplane capability as well as the operator's relevant operational experience, before granting an EDTO approval.
- 1.2 Determination of the diversion time.
- a. Performance Class A aeroplanes with a maximum approved passenger seating configuration of 20 or more;
 - i. two turbine engines - for determining whether a point on the route is beyond the diversion time to an en-route alternate, the operator should select an approved one-engine-inoperative (OEI) speed. The distance is calculated from the point of the diversion followed by cruise for 60 minutes, in ISA and still air conditions. For the purposes of computing distances, credit for drift-down may be taken.
 - ii. aeroplanes with more than two turbine engines - for determining whether a point on the route is beyond the diversion time to an en-route alternate, the operator should select an approved all-engine-operative (AEO) speed. The distance is calculated from the point of the diversion followed by cruise for 120 minutes, in ISA and still air.
 - b. Performance Class A aeroplanes with a maximum approved passenger seating configuration of 19 or less;
 - i. two turbine engines - for determining whether a point on the route is beyond the diversion time to an en-route alternate, the operator should select an approved one-engine-inoperative (OEI) speed. The distance is calculated from the point of the diversion followed by cruise for 120 minutes or, subject to approval by the authority, up to 180 minutes for turbojet aeroplanes, in ISA and still air conditions. For the purposes of computing distances, credit for drift-down may be taken.
 - ii. aeroplanes with more than two turbine engines - for determining whether a point on the route is beyond the diversion time to an en-route alternate, the operator should select an approved all-engine-operative (AEO) speed. The distance is calculated from the point of the diversion followed by cruise for 180 minutes, in ISA and still air.
 - c. Performance Class B or C aeroplanes;
 - i. for determining whether a point on the route is beyond the diversion time to an en-route alternate, the operator should select an approved one-engine-inoperative (OEI) speed. The distance is calculated from the point of the diversion followed by cruise for 120 minutes in ISA and still air conditions or 300 NM whichever is less.

1.3 Training

Training programmes should ensure area, route and aerodrome qualifications are complied with such as, but not limited to, route qualification, flight preparation, concept of extended diversion time operations and criteria for diversions.

1.4 Flight dispatch and operational requirements

In applying the general flight dispatch requirements particular attention should be paid to the conditions which might prevail any time that the operation is beyond 60 minutes to an en-route alternate aerodrome, e.g. systems degradation, reduced flight altitude, etc. At least the following aspects should be considered:

- a. identify en-route alternate airports;
- b. ensure that prior to departure the flight crew is provided with the most up-to-date information on the identified en-route alternate aerodromes, including operational status and meteorological conditions and, in flight, make available means for the flight crew to obtain the most up-to-date weather information;



- c. methods to enable two-way communications between the aeroplane and the operator’s operational control centre;
- d. ensure that the operator has a means to monitor conditions along the planned route including the identified alternate airports and ensure that procedures are in place so that the flight crew are advised of any situation that may affect the safety of flight;
- e. ensure that the intended route does not exceed the established aeroplane threshold time unless the operator is approved for EDTO operations;
- f. pre-flight system serviceability including the status of items in the minimum equipment list;
- g. communication and navigation facilities and capabilities;
- h. fuel requirements; and
- i. availability of relevant performance information for the identified en-route alternate aerodrome(s).

1.5 In addition, operations conducted by aeroplanes with two turbine engines require that, prior to departure and in flight, the meteorological conditions at identified en-route alternate aerodromes will be at or above the aerodrome operating minima required for the operation during the estimated time of use.

1.6 En-route alternate aerodromes

Aerodrome(s) to which an aircraft may proceed in the event that a diversion becomes necessary while en route, where the necessary services and facilities are available, where aircraft performance requirements can be met, and which are expected to be operational if required, need to be identified any time that the operation is beyond 60 minutes to an en-route alternate aerodrome.

Note: En-route alternate aerodromes may also be the take-off and/or destination aerodromes.

2. **EDTO requirements – Two or more turbine engines**

2.1 Basic concept

This section addresses provisions that apply in addition to those in Section 1 to operations by aeroplanes with two or more turbine engines where the diversion time to an en-route alternate aerodrome is greater than the threshold time established under OPS 1.245.

2.2 EDTO significant systems

EDTO significant systems may be the aeroplane propulsion system and any other aeroplane systems whose failure or malfunctioning could adversely affect safety particular to an EDTO flight, or whose functioning is specifically important to continued safe flight and landing during an aeroplane EDTO diversion.

Many of the aeroplane systems which are essential for non-extended diversion time operations may need to be reconsidered to ensure that the redundancy level and/or reliability will be adequate to support the conduct of safe extended diversion time operations.

The maximum diversion time should not exceed the value of the EDTO significant system limitation(s), if any, for extended diversion time operations identified in the Aeroplane’s Flight Manual directly or by reference, reduced with an operational safety margin, commonly 15 minutes, specified by the Authority.

The specific safety risk assessment to approve operations beyond the time limits of an EDTO significant time-limited system should be based on the safety risk management guidance contained in the operator’s Safety Management Manual.

Hazards should be identified and safety risks assessed according to predicted probability and the severity of the consequences based on the worst foreseeable situation. When addressing the following components of the specific safety risk assessment it should be understood that:

- a. capabilities of the operator refer to the operator’s quantifiable in-service experience, compliance record, aeroplane capability, and overall operational reliability that:



- i. is sufficient to support operations beyond the time limits of an EDTO significant time-limited system;
 - ii. demonstrate the ability of the operator to monitor and respond to changes in a timely manner; and
 - iii. there is an expectation that the operator's established processes, necessary for successful and reliable extended diversion time operations, can be successfully applied to such operations;
- b. overall reliability of the aeroplane refers:
- i. to quantifiable standards of reliability taking into account the number of engines, aircraft EDTO significant systems and any other factors that may affect operations beyond the time limits of a particular EDTO significant time limited system; and
 - ii. relevant data from the aeroplane manufacturer and data from the operator reliability program used as a basis to determine overall reliability of the aeroplane and its EDTO significant systems;
- c. reliability of each time limited system refers to quantifiable standards of design, testing and monitoring that ensure the reliability of each particular EDTO significant time limited system;
- d. relevant information from the aeroplane manufacturer refers to technical data and characteristics of the aeroplane and worldwide fleet operational data provided by the manufacturer and used as a basis to determine overall reliability of the aeroplane and its EDTO significant systems; and
- e. specific mitigation measures refer to the safety risk management mitigation strategies, which have manufacturer concurrence, that ensure an equivalent level of safety is maintained. These specific mitigations shall be based on:
- i. technical expertise (e.g. data, evidence) proving the operator's eligibility for an approval of operations beyond the time limit of the relevant EDTO significant system; and
 - ii. an assessment of relevant hazards, their probability and severity of the consequences that may adversely impact the safety of the operation, of an aeroplane operated beyond the limit of a particular EDTO significant time limited system.

2.3 Maximum diversion time

It should be understood that the maximum diversion time to be approved should take into consideration the most limiting EDTO significant system time limitation, if any, indicated in the Aeroplane's Flight Manual (directly or by reference) for a particular aeroplane type and the operator's operational and EDTO experience, if any, with the aeroplane type, or if relevant with another aeroplane type or model.

2.4 Operational and diversion planning principles

When planning or conducting, extended diversion time operations, the operator and pilot-in-command, should ensure that:

- a. when planning an EDTO flight, the minimum equipment list, the communications and navigation facilities, fuel and oil supply, en-route alternate aerodromes and aeroplane performance, are appropriately considered;
- b. if no more than one engine is shut down, the pilot-in-command may elect to continue beyond the nearest en-route alternate aerodrome (in terms of time) if he determines that it is safe to do so. In making this decision the pilot-in-command should consider all relevant factors; and
- c. in the event of a single or multiple failure of an EDTO significant system or systems (excluding engine failure), proceed to and land at the nearest available en-route alternate aerodrome where a safe landing can be made unless it has been determined that no substantial degradation of safety results from any decision made to continue the planned flight.



2.5 EDTO critical fuel

An aeroplane with more than two engines engaged in EDTO operations should carry enough fuel to fly to an en-route alternate aerodrome. The following should be considered, using the anticipated mass of the aeroplane, in determining the corresponding EDTO critical fuel:

- a. fuel sufficient to fly to an en-route alternate aerodrome, considering at the most critical point of the route, simultaneous engine failure and depressurisation or depressurisation alone, whichever is more limiting;
 - i. the speed selected for the diversions (i.e. depressurisation, combined or not with an engine failure) may be different from the approved all-engine operative speed used to determine the EDTO threshold and maximum diversion distance.
- b. fuel to account for icing;
- c. fuel to account for errors in wind forecasting;
- d. fuel to account for holding, an instrument approach and landing at the en-route alternate aerodrome;
- e. fuel to account for deterioration in cruise fuel burn performance; and
- f. fuel to account for APU use (if required).

Note: Guidance on EDTO critical fuel planning can be found in the Flight Planning and Fuel Management Manual (Doc 9976) and in the Extended Diversion Time Operations Manual (Doc 10085).

2.6 Aerodrome Considerations

The following factors may be considered in determining if a landing at a given aerodrome is the more appropriate course of action:

- a. aeroplane configuration, weight, systems status, and fuel remaining;
- b. wind and weather conditions en-route at the diversion altitude, minimum altitudes en-route and fuel consumption to the en-route alternate aerodrome;
- c. runways available, runway surface condition, weather, wind and terrain, in proximity of the en-route alternate aerodrome;
- d. instrument approaches and approach/runway lighting available, rescue and fire fighting services (RFFS) at the en-route alternate aerodrome;
- e. the pilot's familiarity with that aerodrome and information about that aerodrome provided to the pilot by the operator; and
- f. facilities for passenger and crew disembarkation and accommodation.

2.7 En-route alternate aerodromes

In addition to the en-route alternate aerodrome provisions described in Section 1 the following apply:

- a. for route planning purposes, identified en-route alternate aerodromes need to be located at a distance within the maximum diversion time from the route and which could be used if necessary; and
- b. in extended diversion time operations, before an aeroplane crosses its threshold time during flight, there should always be an en-route alternate aerodrome within the approved maximum diversion time whose conditions will be at or above the operator's established aerodrome operating minima for the operation during the estimated time of use.
- c. If any conditions, such as weather below landing minima, are identified that would preclude a safe approach and landing at that aerodrome during the estimated time of use, an alternative course of action should be determined such as selecting another en-route alternate aerodrome within the operator's approved maximum diversion time.



3. EDTO requirements – Two turbine engines

3.1 Basic concept

This section addresses provisions that apply in addition to those in Section 1 to operations by aeroplanes with two turbine engines where the diversion time to an en-route alternate aerodrome is greater than the threshold time established under OPS 1.245.

The Authority, as the State of the Operator of an aeroplane type with two turbine engines which, prior to 25 March 1986, was authorised and operating on a route where the flight time at one-engine-inoperative cruise speed to an en-route alternate aerodrome exceeded the threshold time established for such operations may give consideration to permitting such an operation to continue on that route after that date.

3.2 Operational and diversion planning principles

When planning or conducting, extended diversion time operations, the operator and pilot in command, should normally ensure that:

- a. when planning an EDTO flight, the minimum equipment list, the communications and navigation facilities, fuel and oil supply, en-route alternate aerodromes or aeroplane performance, are appropriately considered;
- b. if an aeroplane engine shutdown, proceed to and land at the nearest (in terms of the least flying time) en-route alternate aerodrome where a safe landing can be made; and
- c. in the event of a single or multiple failure of an EDTO significant systems or systems (excluding engine failure), proceed to and land at the nearest available en-route alternate aerodrome where a safe landing can be made unless it has been determined that no substantial degradation of safety results from any decision made to continue the planned flight.

3.3 EDTO critical fuel

An aeroplane with two engines engaged in EDTO operations should carry enough fuel to fly to an en-route alternate aerodrome as described in OPS 1.255. The following should be considered, using the anticipated mass of the aeroplane, in determining the corresponding EDTO critical fuel:

- a. fuel sufficient to fly to an en-route alternate aerodrome, considering at the most critical point of the route, failure of one engine or simultaneous engine failure and depressurisation or depressurisation alone, whichever is more limiting;
 - i. the speed selected for the all-engine-operative diversion (i.e. depressurisation alone) may be different from the approved one-engine-inoperative speed used to determine the EDTO threshold and maximum diversion distance.
 - ii. the speed selected for the one-engine-inoperative diversions (i.e. engine failure alone and combined engine failure and depressurisation) should be the approved one-engine-inoperative speed used to determine the EDTO threshold and maximum diversion distance.
- b. fuel to account for icing;
- c. fuel to account for errors in wind forecasting;
- d. fuel to account for holding, an instrument approach and landing at the en-route alternate aerodrome;
- e. fuel to account for deterioration in cruise fuel burn performance; and
- f. fuel to account for APU use (if required).

3.4 Aerodrome Considerations

The following factors may be considered in determining if a landing at a given aerodrome is the more appropriate course of action:



- a. aeroplane configuration, weight, systems status, and fuel remaining;
- b. wind and weather conditions en-route at the diversion altitude, minimum altitudes en-route and fuel consumption to the en-route alternate aerodrome;
- c. runways available, runway surface condition, weather, wind, and terrain, in proximity of the en-route alternate aerodrome;
- d. instrument approaches and approach/runway lighting available, rescue and fire fighting services (RFFS) at the en-route alternate aerodrome;
- e. pilot's familiarity with that aerodrome and information about that aerodrome provided to the pilot by the operator; and
- f. facilities for passenger and crew disembarkation and accommodation.

3.5 Maximum diversion time

In approving the maximum diversion time, the Authority will take into consideration the EDTO certified capability of the aeroplane, the aeroplanes EDTO significant systems (e.g. limiting time limitation, if any, and relevant to that particular operation) for a particular aeroplane type and the operator's operational and EDTO experience with the aeroplane type, or if relevant, with another aeroplane type or model.

The operator's approved maximum diversion time should not exceed the EDTO certified capability of the aeroplane nor the most limiting EDTO significant system time limitation identified in the Aeroplane's Flight Manual reduced by an operational safety margin specified, commonly 15 minutes, by the Authority.

3.6 EDTO significant systems

The reliability of the propulsion system for the aeroplane-engine combination being certified is such that the risk of double engine failures from independent causes is assessed and found acceptable to support the diversion time being approved.

For all operations beyond the EDTO threshold as determined by the Authority, the operator should consider, at time of dispatch and as outlined below, the EDTO certified capability of the aeroplane and the most limiting EDTO significant system time limitation, if any, indicated in the Aeroplane's Flight Manual (directly or by reference) and relevant to that particular operations.

The operator should check that from any point on the route, the maximum diversion time at the approved speed does not exceed the most limiting EDTO significant system time limitation, other than the cargo fire suppression system, reduced with an operational safety margin of 15 minutes.

The operator should check that from any point on the route, the maximum diversion time, at all engine operating cruise speed, considering ISA and still air conditions, does not exceed the cargo fire suppression system time limitation reduced with an operational safety margin of 15 minutes.

3.7 En-route alternate aerodromes

In addition to the en-route alternate aerodrome provisions described in Section 1 the following apply:

- a. for route planning purposes, identified en-route alternate aerodromes need to be located at a distance within the maximum diversion time from the route and which could be used if necessary; and
- b. in extended diversion time operations, before an aeroplane crosses its threshold time during flight, there should always be an en-route alternate aerodrome within the approved maximum diversion time whose conditions will be at or above the operator's established aerodrome operating minima for the operation during the estimated time of use.

If any conditions, such as weather below landing minima, are identified that would preclude a safe approach and landing at that aerodrome during the estimated time of use, an alternative course of action should be determined such as selecting another en-route alternate aerodrome within the operator's approved maximum diversion time. During flight preparation and throughout the flight the most up-to-date information should be provided to the flight crew on the identified en-route alternate aerodromes, including operational status and meteorological conditions.



In addition, operations conducted by aeroplanes with two turbine engines require that prior to departure and in flight, the meteorological conditions at identified en-route alternate aerodromes will be at or above the aerodrome operating minima required for the operation during the estimated time of use.

AMC OPS 1.250
Establishment of Minimum Flight Altitudes
See OPS 1.250

1. The following are examples of some of the methods available for calculating minimum flight altitudes.

2. KSS Formula

2.1 Minimum obstacle clearance altitude (MOCA). MOCA is the sum of:

- a. The maximum terrain or obstacle elevation whichever is highest; plus
- b. 1000 ft for elevation up to and including 6000 ft; or
- c. 2000 ft for elevation exceeding 6000 ft rounded up to the next 100 ft.

2.1.1 The lowest MOCA to be indicated is 2000 ft.

2.1.2 From a VOR station, the corridor width is defined as a borderline starting 5 NM either side of the VOR, diverging 4° from centreline until a width of 20 NM is reached at 70 NM out, thence paralleling the centreline until 140 NM out, thence again diverging 4° until a maximum width of 40 NM is reached at 280 NM out. Thereafter the width remains constant (see figure 1).

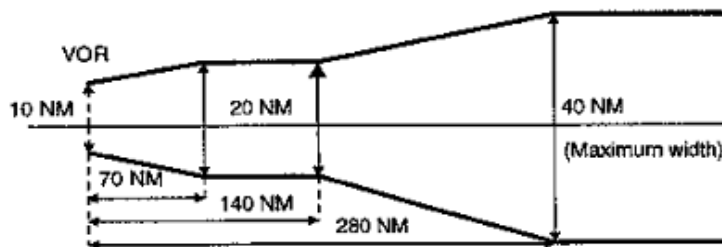

FIGURE 1

2.1.3 From an NDB, similarly, the corridor width is defined as a borderline starting 5 NM either side of the NDB diverging 7° until a width of 20 NM is reached 40 NM out, thence paralleling the centreline until 80 NM out, thence again diverging 7° until a maximum width of 60 NM is reached 245 NM out. Thereafter the width remains constant (see figure 2).

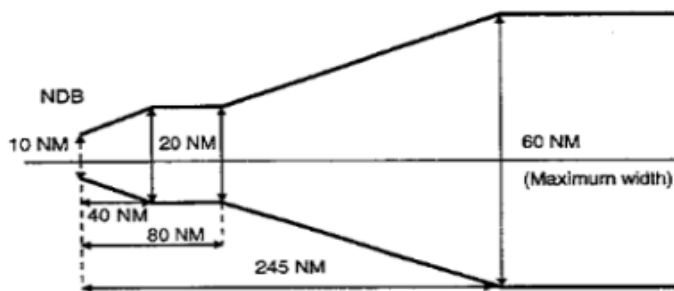

FIGURE 2

2.1.4 MOCA does not cover any overlapping of the corridor.

2.2 Minimum off-route altitude (MORA). MORA is calculated for an area bounded by every or every second LAT/LONG square on the Route Facility Chart (RFC)/Terminal Approach Chart (TAC) and is based on a terrain clearance as follows:

- a. Terrain with elevation up to 6000 ft (2000 m) – 1000 ft above the highest terrain and obstructions;
- b. Terrain with elevation above 6000 ft (2000 m) – 2000 ft above the highest terrain and obstructions.

3. Jeppesen Formula (see figure 3)



- 3.1 MORA is a minimum flight altitude computed by Jeppesen from current ONC or WAC charts. Two types of MORAs are charted which are:
 - a. Route MORAs e.g. 9800a; and
 - b. Grid MORAs e.g. 98.
- 3.2 Route MORA values are computed on the basis of an area extending 10 NM to either side of route centreline and including a 10 NM radius beyond the radio fix/reporting point or mileage break defining the route segment.
- 3.3 MORA values clear all terrain and man-made obstacles by 1000 ft in areas where the highest terrain elevation or obstacles are up to 5000 ft. A clearance of 2000 ft is provided above all terrain or obstacles which are 5 001 ft and above.
- 3.4 A Grid MORA is an altitude computed by Jeppesen and the values are shown within each Grid formed by charted lines of latitude and longitude. Figures are shown in thousands and hundreds of feet (omitting the last two digits so as to avoid chart congestion). Values followed by ± are believed not to exceed the altitudes shown. The same clearance criteria as explained in paragraph 3.3 above apply.

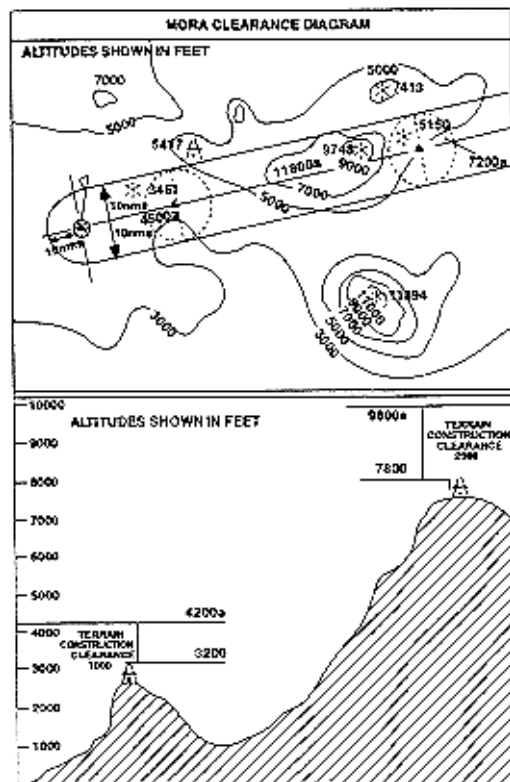

FIGURE 3

- 4. ATLAS Formula
- 4.1 Minimum safe En-route Altitude (MEA). Calculation of the MEA is based on the elevation of the highest point along the route segment concerned (extending from navigational aid to navigational aid) within a distance on either side of track as specified below:
 - a. Segment length up to 100 NM – 10 NM (See Note 1 below).
 - b. Segment length more than 100 NM – 10% of the segment length up to a maximum of 60 NM (See Note 2 below).

Note 1: This distance may be reduced to 5 NM within TMAs where, due to the number and type of available navigational aids, a high degree of navigational accuracy is warranted.

Note 2: In exceptional cases, where this calculation results in an operationally impracticable value, an additional special MEA may be calculated based on a distance of not less than 10 NM either side of track. Such special MEA will be shown together with an indication of the actual width of protected airspace.



- 4.2 The MEA is calculated by adding an increment to the elevation specified above as appropriate:

Elevation of highest point	Increment
Not above 5000 ft	1500 ft
Above 5000 ft but not above 10000 ft	2000 ft
Above 10000 ft	10% of elevation plus 1000 ft

Note: For the last route segment ending over the initial approach fix, a reduction to 1000 ft is permissible within TMAs where, due to the number and type of available navigation aids, a high degree of navigational accuracy is warranted.

The resulting value is adjusted to the nearest 100 ft.

- 4.3 Minimum safe Grid Altitude (MGA). Calculation of the MGA is based on the elevation of the highest point within the respective grid area.

The MGA is calculated by adding an increment to the elevation specified above as appropriate:

Elevation of highest point	Increment
Not above 5000 ft	1500 ft
Above 5000 ft but not above 10000 ft	2000 ft
Above 10000 ft	10% of elevation plus 1000 ft

The resulting value is adjusted to the nearest 100 ft.

AC OPS 1.255

Contingency Fuel Statistical Method

See Appendix 1 to OPS 1.255 (a)(3)(i)(D)

1. As an example, the following values of statistical coverage of the deviation from the planned to the actual trip fuel provides appropriate statistical coverage:
 - a. 99% coverage plus 3% of the trip fuel, if the calculated flight time is less than two hours, or more than two hours and no suitable en-route alternate aerodrome is available;
 - b. 99% coverage if the calculated flight time is more than two hours and a suitable en-route alternate aerodrome is available;
 - c. 90% coverage if:
 - i. the calculated flight time is more than two hours; and
 - ii. a suitable en-route alternate aerodrome is available; and
 - iii. at the destination aerodrome two (2) separate runways are available and usable, one of which is equipped with an ILS/MLS, and the weather conditions are in compliance with OPS 1.295(c)(1)(ii); or the ILS/MLS is operational to Cat II/III operating minima and the weather conditions are at or above 500ft/2 500m.
2. The fuel consumption database used in conjunction with these values shall be based on fuel consumption monitoring for each route/aeroplane combination over a rolling two-year period.

AC OPS 1.260

Carriage of Persons with Reduced Mobility

See OPS 1.260

1. A person with reduced mobility (PRM) is understood to mean a person whose mobility is reduced due to physical incapacity (sensory or locomotory), an intellectual deficiency, age, illness or any other cause of disability when using transport and when the situation needs special attention and the adaptation to a person's need of the service made available to all passengers.
2. In normal circumstances PRMs should not be seated adjacent to an emergency exit.



3. In circumstances in which the number of PRMs forms a significant proportion of the total number of passengers carried on board:
 - a. The number of PRMs should not exceed the number of able-bodied persons capable of assisting with an emergency evacuation; and
 - b. The guidance given in paragraph 2 above should be followed to the maximum extent possible.

AMC OPS 1.270**Cargo Carriage in the Passenger Cabin****See OPS 1.270**

1. In establishing procedures for the carriage of cargo in the passenger cabin of an aeroplane, the operator should observe the following:
 - a. That dangerous goods are not permitted (See also OPS 1.1210(a));
 - b. That a mix of the passengers and live animals should not be permitted except for pets (weighing not more than 8 kg) and guide dogs;
 - c. That the weight of the cargo does not exceed the structural loading limit(s) of the cabin floor or seat(s);
 - d. That the number/type of restraint devices and their attachment points should be capable of restraining the cargo in accordance with FAR 25/EASA CS-25 or equivalent;
 - e. That the location of the cargo should be such that, in the event of an emergency evacuation, it will not hinder egress nor impair the cabin crew's view.

AC OPS 1.280**Passenger Seating****See OPS 1.280**

- 1 The operator should establish procedures to ensure that:
 - a. Those passengers who are allocated seats which permit direct access to emergency exits appear to be reasonably fit, strong and able to assist the rapid evacuation of the aeroplane in an emergency after an appropriate briefing by the crew:
 - b. In all cases, passengers who, because of their condition, might hinder other passengers during an evacuation or who might impede the crew in carrying out their duties should not be allocated seats which permit direct access to emergency exits. If the operator is unable to establish procedures which can be implemented at the time of passenger 'check-in', he should establish an alternative procedure acceptable to the Authority that the correct seat allocation will, in due course, be made.

AMC OPS 1.280**Passenger Seating****See OPS 1.280****See AC OPS 1.280**

- 1 The following categories of passengers are among those who should not be allocated to, or directed to seats which permit direct access to emergency exits:
 - a. Passengers suffering from obvious physical, or mental, handicap to the extent that they would have difficulty in moving quickly if asked to do so;
 - b. Passengers who are either substantially blind or substantially deaf to the extent that they might not readily assimilate printed or verbal instructions given;
 - c. Passengers who because of age or sickness are so frail that they have difficulty in moving quickly;
 - d. Passengers who are so obese that they would have difficulty in moving quickly or reaching and passing through the adjacent emergency exit;
 - e. Children (whether accompanied or not) and infants;
 - f. Deportees or prisoners in custody; and,
 - g. Passengers with animals.



Note: "Direct access" means a seat from which a passenger can proceed directly to the exit without entering an aisle or passing around an obstruction.

AC OPS 1.297(b)(2)**Planning Minima for Alternate Aerodromes****See OPS 1.297(b)(2)**

'Non precision minima' in OPS 1.297, Table 1, means the next highest minimum that is available in the prevailing wind and serviceability conditions; Localizer Only approaches, if published, are considered to be 'non precision' in this context. It is recommended that operators wishing to publish Tables of planning minima choose values that are likely to be appropriate on the majority of occasions (e.g. regardless of wind direction). Unserviceabilities must, however, be fully taken into account.



This Page Intentionally Left Blank



AMC OPS 1.297
Application of Aerodrome Forecasts
 See OPS 1.297

APPLICATION OF AERODROME FORECASTS (TAF & TREND) TO PRE-FLIGHT PLANNING (ICAO Annex 3 refers)							
1. APPLICATION OF INITIAL PART OF TAF (For aerodrome planning minima see OPS 1.297) a) Applicable time period : From the start of the TAF validity period up to the time of applicability of the first subsequent 'FM...*' or 'BECMG' or, if no 'FM' or 'BECMG' is given, up to the end of the validity period of the TAF. b) Application of forecast: The prevailing weather conditions forecast in the initial part of the TAF should be fully applied with the exception of the mean wind and gusts (and crosswind) which should be applied in accordance with the policy in the column 'BECMG AT and FM' in the table below. This may however be overruled temporarily by a 'TEMPO' or 'PROB***' if applicable acc. to the table below.							
2. APPLICATION OF FORECAST FOLLOWING CHANGE INDICATORS IN TAF AND TREND							
TAF or TREND for AERODROME PLANNED AS:	FM (alone) and BECMG AT: Deterioration and Improvement	BECMG (alone), BECMG FM, BECMG TL, BECMG FM ...* TL, in case of:		TEMPO (alone), TEMPO FM, TEMPO TL, TEMPO FM ... TL, PROB30/40 (alone)		PROB TEMPO Deterioration and Improvement	
		Deterioration	Improvement	Deterioration			Improvement In any case
				Transient/Showery Conditions in connection with short-lived weather phenomena, e.g. thunderstorms, showers	Persistent Conditions in connection with e.g. haze, mist, fog, dust/sandstorm, continuous precipitation		
DESTINATION at ETA ± 1 HR TAKE-OFF ALTERNATE at ETA ± 1 HR DEST. ALTERNATE at ETA ± 1 HR ENROUTE ALTERNATE at ETA ± 1 HR (See JAR-OPS AMC 1.255)	Applicable from the start of the change . Mean wind: Should be within required limits; Gusts: May be disregarded.	Applicable from the time of start of the change. Mean wind: Should be within required limits; Gusts: May be disregarded.	Applicable from the time of end of the change. Mean wind: Should be within required limits; Gusts: May be disregarded.	Not applicable Mean wind and gusts exceeding required limits may be disregarded .	Applicable Mean wind: Should be within required limits; Gusts: May be disregarded	Should be disregarded.	Deterioration may be disregarded; Improvement should be disregarded including mean wind and gusts.
ETOPS ENRT ALTN at earliest/latest ETA ± 1 HR	Applicable from the time of start of change; Mean wind: Should be within required limits; Gusts exceeding crosswind limits should be fully applied.	Applicable from the time of start of change; Mean wind: Should be within required limits; Gusts exceeding crosswind limits should be fully applied.	Applicable from the time of end of the change; Mean wind: Should be within required limits; Gusts exceeding crosswind limits should be fully applied.	Applicable if below applicable landing minima Mean wind: Should be within required limits; Gusts exceeding crosswind limits should be fully applied.	Applicable if below applicable landing minima Mean wind: Should be within required limits; Gusts exceeding crosswind limits should be fully applied.		
Note 1: "Required limits" are those contained in the Operations Manual. Note 2: If promulgated aerodrome forecasts do not comply with the requirements of ICAO Annex 3, operators should ensure that guidance in the application of these reports is provided. * The space following 'FM' should always include a time group e.g. 'FM1030'.							



This Page Intentionally Left Blank

**AMC OPS 1.300****Submission of ATS Flight Plan****See OPS 1.300**

1. Flights without ATS flight plan. When unable to submit or to close the ATS flight plan due to lack of ATS facilities or any other means of communications to ATS, the operator should establish procedures, instructions and a list of authorised persons to be responsible for alerting search and rescue services.
2. To ensure that each flight is located at all times, these instructions should:
 - a. Provide the authorised person with at least the information required to be included in a VFR Flight plan, and the location, date and estimated time for re-establishing communications;
 - b. If an aeroplane is overdue or missing, provide for notification to the appropriate ATS or Search and Rescue facility; and
 - c. Provide that the information will be retained at a designated place until the completion of the flight.

AMC OPS 1.305**Refuelling/Defueling with Passengers Embarking, on Board or Disembarking****See OPS 1.305**

When re/defuelling with passengers on board, ground servicing activities and work inside the aeroplane, such as catering and cleaning, should be conducted in such a manner that they do not create a hazard and that the aisles and emergency doors are unobstructed.

AMC OPS 1.307**Refuelling/Defueling with Wide-cut Fuel****See OPS 1.307**

1. 'Wide cut fuel' (designated JET B, JP-4 or AVTAG) is an aviation turbine fuel that falls between gasoline and kerosene in the distillation range and consequently, compared to kerosene (JET A or JET A1), it has the properties of higher volatility (vapour pressure), lower flash point and lower freezing point.
2. Wherever possible, the operator should avoid the use of wide-cut fuel types. If a situation arises such that only wide-cut fuels are available for refuelling/defuelling, operators should be aware that mixtures of wide-cut fuels and kerosene turbine fuels can result in the air/fuel mixture in the tank being in the combustible range at ambient temperatures. The extra precautions set out below are advisable to avoid arcing in the tank due to electrostatic discharge. The risk of this type of arcing can be minimised by the use of a static dissipation additive in the fuel. When this additive is present in the proportions stated in the fuel specification, the normal fuelling precautions set out below are considered adequate.
3. Wide-cut fuel is considered to be "involved" when it is being supplied or when it is already present in aircraft fuel tanks.
4. When wide-cut fuel has been used, this should be recorded in the Technical Log. The next two uplifts of fuel should be treated as though they too involved the use of wide-cut fuel.
5. When refuelling/defuelling with turbine fuels not containing a static dissipator, and where wide -cut fuels are involved, a substantial reduction on fuelling flow rate is advisable. Reduced flow rate, as recommended by fuel suppliers and/or aeroplane manufacturers, has the following benefits:
 - a. It allows more time for any static charge build-up in the fuelling equipment to dissipate before the fuel enters the tank;
 - b. It reduces any charge which may build up due to splashing; and
 - c. Until the fuel inlet point is immersed, it reduces misting in the tank and consequently the extension of the flammable range of the fuel.
6. The flow rate reduction necessary is dependent upon the fuelling equipment in use and the type of filtration employed on the aeroplane fuelling distribution system. It is difficult, therefore, to quote precise flow rates. Reduction in flow rate is advisable whether pressure fuelling or over-wing fuelling is employed.



7. With over-wing fuelling, splashing should be avoided by making sure that the delivery nozzle extends as far as practicable into the tank. Caution should be exercised to avoid damaging bag tanks with the nozzle.

AC OPS 1.308
Push Back and Towing
See OPS 1.308

Towbarless towing should be based on the applicable SAE ARP (Aerospace Recommended Practices), i.e.4852B/4853B/5283/5284/5285 (as amended).

AC OPS 1.310(a)(3)
Controlled Rest on Flight Deck
See OPS 1.310(a)(3)

Even though crew members should stay alert at all times during flight, unexpected fatigue can occur as a result of sleep disturbance and circadian disruption. To cover for this unexpected fatigue, and to regain a high level of alertness, a controlled rest procedure on the Flight Deck can be used. Moreover, the use of controlled rest has been shown to increase significantly levels of alertness during the later phases of flight, particularly after the top of descent, and is considered a good use of CRM principles. Controlled rest should be used in conjunction with other on board fatigue management countermeasures such as physical exercise, bright flight crew compartment illumination at appropriate times, balanced eating and drinking, and intellectual activity. The maximum rest time has been chosen to limit deep sleep with consequent long recovery time (sleep inertia).

1. It is the responsibility of all crew members to be properly rested before flight (see OPS 1.085).
2. This AC is concerned with controlled rest taken by the minimum certificated flight crew. It is not concerned with resting by members of an augmented crew.
3. Controlled rest means a period of time 'off task' some of which may include actual sleep.
4. Controlled rest may be used at the discretion of the commander to manage both sudden unexpected fatigue and fatigue which is expected to become more severe during higher workload periods later in the flight. It cannot be planned before flight.
5. Controlled rest should only take place during a low workload part of the flight.
6. Controlled rest periods should be agreed according to individual needs and the accepted principles of CRM; where the involvement of the cabin crew is required, consideration should be given to their workload.
7. Only one crew member at a time should take rest, at his station; the harness should be used and the seat positioned to minimise unintentional interference with the controls.
8. The commander should ensure that the other flight crew member(s) is (are) adequately briefed to carry out the duties of the resting crew member. One pilot must be fully able to exercise control of the aeroplane at all times. Any system intervention which would normally require a cross check according to multi crew principles should be avoided until the resting crew member resumes his duties.
9. Controlled rest may be taken according the following conditions:
 - a. The rest period should be no longer than 45 minutes (in order to limit any actual sleep to approximately 30 minutes).
 - b. After this 45-minute period, there should be a recovery period of 20 minutes during which sole control of the aeroplane should not be entrusted to the pilot who has completed his rest.
 - c. In the case of 2-crew operations, means should be established to ensure that the non-resting flight crew member remains alert. This may include:
 - Appropriate alarm systems
 - Onboard systems to monitor crew activity



- Frequent Cabin Crew checks; In this case, the commander should inform the senior cabin crewmember of the intention of the flight crew member to take controlled rest, and of the time of the end of that rest; Frequent contact should be established between the flight deck and the cabin crew by means of the interphone, and cabin crew should check that the resting crew member is again alert at the end of the period. The frequency of the contacts should be specified in the Ops Manual.
10. A minimum 20 minute period should be allowed between rest periods to overcome the effects of sleep inertia and allow for adequate briefing.
 11. If necessary, a flight crew member may take more than one rest period if time permits on longer sectors, subject to the restrictions above.
 12. Controlled rest periods should terminate at least 30 minutes before top of descent.

AMC OPS 1.310(b)**Cabin Crew Seating Positions****See OPS 1.310(b)**

1. When determining cabin crew seating positions, the operator should ensure that they are:
 - i. Close to a floor level exit;
 - ii. Provided with a good view of the area(s) of the passenger cabin for which the cabin crew member is responsible; and
 - iii. Evenly distributed throughout the cabin,in the above order of priority.
2. Paragraph 1 above should not be taken as implying that, in the event of there being more such cabin crew stations than required cabin crew, the number of cabin crew members should be increased.

AC OPS 1.311(b)(i)**Minimum Number of Cabin Crew Required to be on Board an Aeroplane during Disembarkation when the Number of Passengers Remaining on Board is Less than 20****See OPS 1.311(b)(i)**

1. When developing the procedure(s) in relation to OPS 1.311(b)(i) the following should be taken into account:
 - a. The possibility of gathering the remaining passengers in one part of each deck or of the deck, depending upon their initial seat allocation,
 - b. The possible occurrence of refuelling/defuelling,
 - c. The associated number and distribution of cabin crew and the possible presence of flight crew on board, until the last passenger has disembarked,
 - d. AC OPS 1.260 3a.

AC OPS 1.345**Ice and Other Contaminants Procedures**

1. General
 - a. Any deposit of frost, ice, snow or slush on the external surfaces of an aeroplane may drastically affect its flying qualities because of reduced aerodynamic lift, increased drag, modified stability and control characteristics. Furthermore, freezing deposits may cause moving parts, such as elevators, ailerons, flap actuating mechanism etc., to jam and create a potentially hazardous condition. Propeller/engine/APU/ systems performance may deteriorate due to the presence of frozen contaminants to blades, intakes and components.



- b. Also, engine operation may be seriously affected by the ingestion of snow or ice, thereby causing engine stall or compressor damage. In addition, ice/frost may form on certain external surfaces (e.g. wing upper and lower surfaces, etc.) due to the effects of cold fuel/structures, even in ambient temperatures well above 0° C.
- b. The procedures established by the operator for de-icing and/or anti-icing in accordance with OPS 1.345 are intended to ensure that the aeroplane is clear of contamination so that degradation of aerodynamic characteristics or mechanical interference will not occur and, following anti-icing, to maintain the airframe in that condition during the appropriate holdover time. The de-icing and/or anti-icing procedures should therefore include requirements, including type-specific, taking into account manufacturer's recommendations and cover:
- i. Contamination checks, including detection of clear ice and under-wing frost.
Note: limits on the thickness/area of contamination published in the AFM or other manufacturers' documentation should be followed;
 - ii. De-icing and/or anti-icing procedures including procedures to be followed if de-icing and/or anti-icing procedures are interrupted or unsuccessful;
 - iii. Post-treatment checks;
 - iv. Pre take-off checks;
 - v. Pre take-off contamination checks;
 - vi. The recording of any incidents relating to de-icing and/or anti-icing; and
 - vii. The responsibilities of all personnel involved in de-icing and/or anti-icing.
- c. Under certain meteorological conditions de-icing and/or anti-icing procedures may be ineffective in providing sufficient protection for continued operations. Examples of these conditions are freezing rain, ice pellets and hail, heavy snow, high wind velocity, fast dropping OAT or any time when freezing precipitation with high water content is present. No Holdover Time Guidelines exist for these conditions.
- d. Material for establishing operational procedures can be found, for example, in:
- ICAO Annex 3, Meteorological Service for International Air Navigation;
 - ICAO Doc 9640-AN/940 "Manual of aircraft ground de-icing/anti-icing operations";
 - ISO 11075 () ISO Type I fluid;
 - ISO 11076 () Aircraft de-icing/anti-icing methods with fluids;
 - ISO 11077 () Self-propelled de-icing/anti-icing vehicles-functional requirements;
 - ISO 11078 () ISO Type II fluid;
 - FAA guidance material
https://www.faa.gov/other_visit/aviation_industry/airline_operators/airline_safety/deicing/
 - Transport Canada guidance material
<https://www.tc.gc.ca/en/services/aviation/general-operating-flight-rules/de-icing-aircraft/hold-over-guidelines.html>
 - EUROCAE ED-104/SAE AS 5116 Minimum operational performance specification for ground ice detection systems;
 - SAE ARP 4737 Aircraft de-icing/anti-icing methods;
 - SAE AMS 1424 Type I fluids;



- SAE AMS 1428 Type II, III and IV fluids;
- SAE ARP 1971 Aircraft De-icing Vehicle, Self-Propelled, Large and Small Capacity;
- SAE ARD 50102 Forced air or forced air/fluid equipment for removal of frozen contaminants;
- SAE ARP 5149 Training Programme Guidelines for De-icing/Anti-icing of Aircraft on Ground.

Note: The revision cycle of ISO documents is infrequent and therefore the documents quoted may not reflect the latest industry standards.

2. Terminology

Terms used in the context of this AC have the following meanings. Explanations of other definitions may be found elsewhere in the documents listed in 1 d. In particular, meteorological definitions may be found in ICAO doc. 9640.

- a. Anti-icing. The procedure that provides protection against the formation of frost or ice and accumulation of snow on treated surfaces of the aeroplane for a limited period of time (holdover time).
- b. Anti-icing fluid. Anti-icing fluid includes but is not limited to the following:
 - i. Type I fluid if heated to min 60° C at the nozzle;
 - ii. Mixture of water and Type I fluid if heated to min 60°C at the nozzle;
 - iii. Type II fluid;
 - iv. Mixture of water and Type II fluid;
 - v. Type III fluid;
 - vi. Mixture of water and Type III fluid;
 - vii. Type IV fluid;
 - viii. Mixture of water and Type IV fluid.

Note: On uncontaminated aeroplane surfaces Type II, III and IV anti-icing fluids are normally applied unheated.

- c. Clear ice. A coating of ice, generally clear and smooth, but with some air pockets. It forms on exposed objects, the temperature of which are at, below or slightly above the freezing temperature, by the freezing of super-cooled drizzle, droplets or raindrops.
- d. Conditions conducive to aeroplane icing on the ground. Freezing fog, freezing precipitation, frost, rain or high humidity (on cold soaked wings), mixed rain and snow and snow.
- e. Contamination. Contamination in this context is understood as all forms of frozen or semi-frozen moisture such as frost, snow, slush, or ice.
- f. Contamination check. Check of aeroplane for contamination to establish the need for de-icing.
- g. De-icing. The procedure by which frost, ice, snow or slush is removed from an aeroplane in order to provide uncontaminated surfaces.
- h. De-icing fluid. Such fluid includes, but is not limited to, the following:
 - i. Heated water;
 - ii. Type I fluid;
 - iii. Mixture of water and Type I fluid;



- iv. Type II fluid;
- v. Mixture of water and Type II fluid;
- vi. Type III fluid;
- vii. Mixture of water and Type III fluid;
- viii. Type IV fluid;
- ix. Mixture of water and Type IV fluid.

Note: De-icing fluid is normally applied heated to ensure maximum efficiency.

- i. De-icing/anti-icing. This is the combination of de-icing and anti-icing performed in either one or two steps.
- j. Ground Ice Detection System (GIDS). System used during aeroplane ground operations to inform the ground crew and/or the flight crew about the presence of frost, ice, snow or slush on the aeroplane surfaces.
- k. Holdover time (HOT). The estimated period of time for which an anti-icing fluid is expected to prevent the formation of frost or ice and the accumulation of snow on the treated surfaces of an aeroplane on the ground in the prevailing ambient conditions.
- l. Lowest Operational Use Temperature (LOUT). The lowest temperature at which a fluid has been tested and certified as acceptable in accordance with the appropriate aerodynamic acceptance test whilst still maintaining a freezing point buffer of not less than:
 - 10° C for a type I de-icing/anti-icing fluid,
 - 7° C for type II, III or IV de-/anti-icing fluids.
- m. Post-treatment check. An external check of the aeroplane after de-icing and/or anti-icing treatment accomplished from suitably elevated observation points (e.g. from the de-icing equipment itself or other elevated equipment) to ensure that the aeroplane is free from any frost, ice, snow, or slush.
- n. Pre-take-off check. An assessment, normally performed from within the flight deck, to validate the applied holdover time.
- o. Pre-take-off contamination check. A check of the treated surfaces for contamination, performed when the hold-over-time has been exceeded or if any doubt exists regarding the continued effectiveness of the applied anti-icing treatment. It is normally accomplished externally, just before the commencement of the take-off run.

3. Fluids

- a. Type I fluid. Due to its properties, Type I fluid forms a thin, liquid-wetting film on surfaces to which it is applied which, under certain weather conditions, gives a very limited holdover time. With this type of fluid, increasing the concentration of fluid in the fluid/water mix does not provide any extension in holdover time.
- b. Type II and type IV fluids contain thickeners which enable the fluid to form a thicker liquid-wetting film on surfaces to which it is applied. Generally, this fluid provides a longer holdover time than Type I fluids in similar conditions. With this type of fluid, the holdover time can be extended by increasing the ratio of fluid in the fluid/water mix.
- c. Type III fluid: a thickened fluid intended especially for use on aeroplanes with low rotation speeds.
- d. Fluids used for de-icing/anti-icing should be acceptable to the operator and the aeroplane manufacturer. These fluids conform to specifications such as SAE AMS 1424, 1428 or equivalent. Use of non-conforming fluids is not recommended due to their characteristics not being known.



Note: The anti-icing and aerodynamic properties of thickened fluids may be seriously degraded by, for example, inappropriate storage, treatment, application, application equipment and age.

4. Communications

4.1 Before aeroplane treatment.

When the aeroplane is to be treated with the flight crew on board, the flight and ground crews should confirm the fluid to be used, the extent of treatment required, and any aeroplane type-specific procedure(s) to be used. Any other information needed to apply the HOT tables should be exchanged.

4.2 Anti-icing code

- a. The operator's procedures should include an anti-icing code, which indicates the treatment the aeroplane has received. This code provides the flight crew with the minimum details necessary to estimate a holdover time (see para 5 below) and confirms that the aeroplane is free of contamination.
- b. The procedures for releasing the aeroplane after the treatment should therefore provide the commander with the anti-icing code.
- c. Anti-icing Codes to be used (examples):
 - i. "Type I" at (start time) – To be used if anti-icing treatment has been performed with a Type I fluid;
 - ii. "Type II/100" at (start time) – To be used if anti-icing treatment has been performed with undiluted Type II fluid;
 - iii. "Type II/75" at (start time) – To be used if anti-icing treatment has been performed with a mixture of 75% Type II fluid and 25% water;
 - iv. "Type IV/50" at (start time) – To be used if anti-icing treatment has been performed with a mixture of 50% Type IV fluid and 50% water.

Note: When a two-step de-icing/anti-icing operation has been carried out, the Anti-Icing Code is determined by the second step fluid. Fluid brand names may be included, if desired.

4.3 After Treatment

Before reconfiguring or moving the aeroplane, the flight crew should receive a confirmation from the ground crew that all de-icing and/or anti-icing operations are complete and that all personnel and equipment are clear of the aeroplane.

5. Holdover protection

- a. Holdover protection is achieved by a layer of anti-icing fluid remaining on and protecting aeroplane surfaces for a period of time. With a one-step de-icing/anti-icing procedure, the holdover time (HOT) begins at the commencement of de-icing/anti-icing. With a two-step procedure, the holdover time begins at the commencement of the second (anti-icing) step. The holdover protection runs out:
 - i. At the commencement of take-off roll (due to aerodynamic shedding of fluid) or
 - ii. When frozen deposits start to form or accumulate on treated aeroplane surfaces, thereby indicating the loss of effectiveness of the fluid.
- b. The duration of holdover protection may vary subject to the influence of factors other than those specified in the holdover time (HOT) tables. Guidance should be provided by the operator to take account of such factors which may include:
 - i. Atmospheric conditions, e.g. exact type and rate of precipitation, wind direction and velocity, relative humidity and solar radiation and
 - ii. The aeroplane and its surroundings, such as aeroplane component inclination angle, contour and surface roughness, surface temperature, operation in close proximity to other



aeroplanes (jet or propeller blast) and ground equipment and structures.

- c. Holdover times are not meant to imply that flight is safe in the prevailing conditions if the specified holdover time has not been exceeded. Certain meteorological conditions, such as freezing drizzle or freezing rain, may be beyond the certification envelope of the aeroplane.
 - d. The operator should publish in the Operations Manual the holdover times in the form of a table or diagram to account for the various types of ground icing conditions and the different types and concentrations of fluids used. However, the times of protection shown in these tables are to be used as guidelines only and are normally used in conjunction with pre-take-off check.
 - e. References to usable HOT tables may be found in the 'FAA or Transport Canada guidance material at paragraph 1d.
6. Procedures to be used. Operator's procedures should ensure that:
- a. When aeroplane surfaces are contaminated by ice, frost, slush or snow, they are de-iced prior to take-off; according to the prevailing conditions. Removal of contaminants may be performed with mechanical tools, fluids (including hot water), infra-red heat or forced air, taking account of aeroplane type-specific requirements.
 - b. Account is taken of the wing skin temperature versus OAT, as this may affect:
 - i. The need to carry out aeroplane de-icing and/or anti-icing; and
 - ii. The performance of the de-icing/anti-icing fluids.
 - c. When freezing precipitation occurs or there is a risk of freezing precipitation occurring, which would contaminate the surfaces at the time of take-off, aeroplane surfaces should be anti-iced. If both de-icing and anti-icing are required, the procedure may be performed in a one or two-step process depending upon weather conditions, available equipment, available fluids and the desired holdover time. One-step de-icing/ anti-icing means that de-icing and anti-icing are carried out at the same time using a mixture of de-icing/ anti-icing fluid and water. Two-step de-icing/anti-icing means that de-icing and anti-icing are carried out in two separate steps. The aeroplane is first de-iced using heated water only or a heated mixture of de-icing/anti-icing fluid and water. After completion of the de-icing operation a layer of a mixture of de-icing/anti-icing fluid and water, or of de-icing/anti-icing fluid only, is to be sprayed over the aeroplane surfaces. The second step will be applied, before the first step fluid freezes, typically within three minutes and, if necessary, area by area.
 - d. When an aeroplane is anti-iced and a longer holdover time is needed/desired, the use of a less diluted Type II or Type IV fluid should be considered.
 - e. All restrictions relative to Outside Air Temperature (OAT) and fluid application (including, but not necessarily limited to temperature and pressure), published by the fluid manufacturer and/or aeroplane manufacturer, are followed. Procedures, limitations and recommendations to prevent the formation of fluid residues are followed.
 - f. During conditions conducive to aeroplane icing on the ground or after de-icing and/or anti-icing, an aeroplane is not dispatched for departure unless it has been given a contamination check or a post-treatment check by a trained and qualified person. This check should cover all treated surfaces of the aeroplane and be performed from points offering sufficient accessibility to these parts. To ensure that there is no clear ice on suspect areas, it may be necessary to make a physical check (e.g. tactile).
 - g. The required entry is made in the Technical Log. (See AMC OPS 1.915, par. 2, Section 3.vi.).
 - h. The commander continually monitors the environmental situation after the performed treatment. Prior to take-off he performs a pre-take-off check, which is an assessment whether the applied HOT is still appropriate. This pre-take-off check includes, but is not limited to, factors such as precipitation, wind and OAT.
 - i. If any doubt exists as to whether a deposit may adversely affect the aeroplane's performance and/or controllability characteristics, the commander should require a pre-take-off contamination check to be performed in order to verify that the aeroplane's surfaces are free of contamination. Special



methods and/or equipment may be necessary to perform this check, especially at night time or in extremely adverse weather conditions. If this check cannot be performed just prior to take-off, re-treatment should be applied.

- j. When re-treatment is necessary, any residue of the previous treatment should be removed and a completely new de-icing/anti-icing treatment applied.
- k. When a Ground Ice Detection System (GIDS) is used to perform an aeroplane surfaces check prior to and/or after a treatment, the use of GIDS by suitably trained personnel should be a part of the procedure.

7. Special operational considerations

- a. When using thickened de-icing/anti-icing fluids, the operator should consider a two-step de-icing/anti-icing procedure, the first step preferably with hot water and/or non thickened fluids.
- b. The use of de-icing/anti-icing fluids has to be in accordance with the aeroplane manufacturer's documentation. This is particular true for thickened fluids to assure sufficient flow-off during take-off.
- c. The operator should comply with any type-specific operational requirement(s) such as an aeroplane mass decrease and/or a take-off speed increase associated with a fluid application.
- d. The operator should take into account any flight handling procedures (stick force, rotation speed and rate, take-off speed, aeroplane attitude etc.) laid down by the aeroplane manufacturer when associated with a fluid application.
- e. The limitations or handling procedures resulting from c and/or d above should be part of the flight crew pre take-off briefing.

8. Special maintenance considerations

a. General

The operator should take proper account of the possible side-effects of fluid use. Such effects may include, but are not necessarily limited to, dried and/or re-hydrated residues, corrosion and the removal of lubricants.

b. Special considerations due to residues of dried fluids.

The operator should establish procedures to prevent or detect and remove residues of dried fluid. If necessary the operator should establish appropriate inspection intervals based on the recommendations of the airframe manufacturers and/or own experience:

i. Dried fluid residues.

Dried fluid residue could occur when surfaces has been treated but the aircraft has not subsequently been flown and not been subject to precipitation. The fluid may then have dried on the surfaces;

ii. Re-hydrated fluid residues.

Repetitive application of thickened de-icing/anti-icing fluids may lead to the subsequent formation/build-up of a dried residue in aerodynamically quiet areas, such as cavities and gaps. This residue may re-hydrate if exposed to high humidity conditions, precipitation, washing, etc., and increase to many times its original size/volume.

This residue will freeze if exposed to conditions at or below 0° C. This may cause moving parts such as elevators, ailerons, and flap actuating mechanisms to stiffen or jam in flight.

Re-hydrated residues may also form on exterior surfaces, which can reduce lift, increase drag and stall speed. Re-hydrated residues may also collect inside control surface structures and cause clogging of drain holes or imbalances to flight controls. Residues may also collect in hidden areas: around flight control hinges, pulleys, grommets, on cables and in gaps;



- iii. Operators are strongly recommended to request information about the fluid dry-out and rehydration characteristics from the fluid manufacturers and to select products with optimised characteristics;
- iv. Additional information should be obtained from fluid manufacturers for handling, storage, application and testing of their products.

9. Training

- a. The operator should establish appropriate initial and recurrent de-icing and/or anti-icing training programmes (including communication training) for flight crew and those of his ground crew who are involved in de-icing and/or anti-icing.
- b. These de-icing and/or anti-icing training programmes should include additional training if any of the following will be introduced:
 - i. A new method, procedure and/or technique;
 - ii. A new type of fluid and/or equipment; and
 - iii. A new type(s) of aeroplane.
- c. The operator should establish appropriate initial and recurrent training for the Cabin Crew, which includes;
 - i. Awareness of the effects of surface contamination; and
 - ii. The need to inform the Flight Crew of any observed surface contamination.

10. Subcontracting (See AMC OPS 1.035 sections 4 and 5)

The operator should ensure that the subcontractor complies with the operator's quality and training/qualification requirements together with the special requirements in respect of:

- a. De-icing and/or anti-icing methods and procedures;
- b. Fluids to be used, including precautions for storage and preparation for use;
- c. Specific aeroplane requirements (e.g. no-spray areas, propeller/engine de-icing, APU operation etc.);
- d. Checking and communications procedures.

AC OPS 1.346

Flight in Expected or Actual Icing Conditions

See OPS 1.346

- 1. The procedures to be established by the operator should take account of the design, the equipment or the configuration of the aeroplane and also of the training which is needed. For these reasons, different aeroplane types operated by the same company may require the development of different procedures. In every case, the relevant limitations are those which are defined in the Aeroplane Flight Manual (AFM) and other documents produced by the manufacturer.
- 2. For the required entries in the Operations Manual, the procedural principles which apply to flight in icing conditions are referred to under Appendix 1 to OPS 1.1045, A 8.3.8 and should be cross-referenced, where necessary, to supplementary, type-specific data under B 4.1.1.
- 3. *Technical content of the Procedures.* the operator should ensure that the procedures take account of the following:
 - a. OPS 1.675;
 - b. The equipment and instruments which must be serviceable for flight in icing conditions;
 - c. The limitations on flight in icing conditions for each phase of flight. These limitations may be imposed by the aeroplane's de-icing or anti-icing equipment or the necessary performance



corrections which have to be made;

- d. The criteria the Flight Crew should use to assess the effect of icing on the performance and/or controllability of the aeroplane;
- e. The means by which the Flight Crew detects, by visual cues or the use of the aeroplane’s ice detection system, that the flight is entering icing conditions; and
- f. The action to be taken by the Flight Crew in a deteriorating situation (which may develop rapidly) resulting in an adverse effect on the performance and/or controllability of the aeroplane, due to either:
 - i. the failure of the aeroplane’s anti-icing or de-icing equipment to control a build-up of ice, and/or
 - ii. ice build-up on unprotected areas.

4. *Training for dispatch and flight in expected or actual icing conditions.* The content of the Operations Manual, Part D, should reflect the training, both conversion and recurrent, which Flight Crew, Cabin Crew and all other relevant operational personnel will require in order to comply with the procedures for dispatch and flight in icing conditions.

4.1 For the Flight Crew, the training should include:

- a. Instruction in how to recognise, from weather reports or forecasts which are available before flight commences or during flight, the risks of encountering icing conditions along the planned route and on how to modify, as necessary, the departure and in-flight routes or profiles;
- b. Instruction in the operational and performance limitations or margins;
- c. The use of in-flight ice detection, anti-icing and de-icing systems in both normal and abnormal operation; and
- d. Instruction in the differing intensities and forms of ice accretion and the consequent action which should be taken.

4.2 For the Cabin Crew, the training should include;

- a. Awareness of the effects of surface contamination; and
- b. The need to inform the Flight Crew of any observed surface contamination.

AC OPS 1.390(a)(1)
Assessment of Cosmic Radiation
See OPS 1.390(a)(1)

1 In order to show compliance with OPS 1.390(a), the operator should assess the likely exposure for crew members so that he can determine whether or not action to comply with OPS 1.390(a)(2), (3), (4) and (5) will be necessary.

- a. Assessment of exposure level can be made by the method described below, or other method acceptable to the Authority:

Table 1 - Hours exposure for effective dose of 1 millisievert (mSv)

Altitude (feet)	Kilometre equivalent	Hours at latitude 60° N	Hours at equator
27000	8.23	630	1330
30000	9.14	440	980
33000	10.06	320	750
36000	10.97	250	600
39000	11.89	200	490
42000	12.80	160	420
45000	13.72	140	380
48000	14.63	120	350

Note: This table, published for illustration purposes, is based on the JARI-3 computer program; and may be superseded by updated versions, as approved by the Authority.

The uncertainty on these estimates is about ± 20%. A conservative conversion factor of 0.8 has been used to convert ambient dose equivalent to effective dose.



- b. Doses from cosmic radiation vary greatly with altitude and also with latitude and with the phase of the solar cycle. Table 1 gives an estimate of the number of flying hours at various altitudes in which a dose of 1 mSv would be accumulated for flights at 60° N and at the equator. Cosmic radiation dose rates change reasonably slowly with time at altitudes used by conventional jet aircraft (i.e. up to about 15 km / 49000 ft).
- c. Table 1 can be used to identify circumstances in which it is unlikely that an annual dosage level of 1 mSv would be exceeded. If flights are limited to heights of less than 8 km (27000 ft), it is unlikely that annual doses will exceed 1 mSv. No further controls are necessary for crew members whose annual dose can be shown to be less than 1 mSv.

AC OPS 1.390(a)(2)**Working Schedules and Record Keeping****See OPS 1.390(a)(2)**

Where in-flight exposure of crew members to cosmic radiation is likely to exceed 1 mSv per year the operator should arrange working schedules, where practicable, to keep exposure below 6 mSv per year. For the purpose of this regulation crew members who are likely to be exposed to more than 6 mSv per year are considered highly exposed and individual records of exposure to cosmic radiation should be kept for each crew member concerned.

AC OPS 1.390(a)(3)**Explanatory Information****See OPS 1.390(a)(3)**

Operators should explain the risks of occupational exposure to cosmic radiation to their crew members. Female crew members should know of the need to control doses during pregnancy, and the operator consequently notified so that the necessary dose control measures can be introduced.

AC OPS 1.398**Use of Airborne Collision Avoidance System (ACAS)****See OPS 1.398**

- 1 The ACAS operational procedures and training programmes established by the operator should take into account Temporary Guidance Leaflet 11 "Guidance for Operators on Training Programmes for the Use of ACAS". This TGL incorporates advice contained in:
 - a. ICAO Annex 10 Volume 4;
 - b. ICAO Doc 8168 PANS OPS Volume 1;
 - c. ICAO Doc 4444 PANS RAC Part X paragraph 3.1.2; and
 - d. ICAO guidance material "ACAS Performance - Based Training Objectives" (published under Attachment E to State letter AN 7/1.3.7.2-97/77.)

AMC OPS 1.400**Approach and Landing Conditions****See OPS 1.400**

The in-flight determination of the landing distance should be based on the latest available report, preferably not more than 30 minutes before the expected landing time.



Appendix 1 to AMC OPS 1.245(a)(2)
Power Supply to Essential Services

1. Any one of the three electrical power sources referred to in sub-paragraph 2.b of AMC OPS 1.245(a)(2) should be capable of providing power for essential services which should normally include:
 - a. Sufficient instruments for the flight crew providing, as a minimum, attitude, heading, airspeed and altitude information;
 - b. Appropriate pitot heating;
 - c. Adequate navigation capability;
 - d. Adequate radio communication and intercommunication capability;
 - e. Adequate flight deck and instrument lighting and emergency lighting;
 - f. Adequate flight controls;
 - g. Adequate engine controls and restart capability with critical type fuel (from the stand-point of flame-out and restart capability) and with the aeroplane initially at the maximum relight altitude;
 - h. Adequate engine instrumentation;
 - i. Adequate fuel supply system capability including such fuel boost and fuel transfer functions that may be necessary for extended duration single or dual engine operation;
 - j. Such warnings, cautions and indications as are required for continued safe flight and landing;
 - k. Fire protection (engines and APU);
 - l. Adequate ice protection including windshield de-icing; and
 - m. Adequate control of the flight deck and cabin environment including heating and pressurisation.
2. The equipment (including avionics) necessary for extended diversion times should have the ability to operate acceptably following failures in the cooling system or electrical power systems.



This Page Intentionally Left Blank



AC/AMC E

ALL WEATHER OPERATIONS

AC OPS 1.430 Continuous Descent Final Approach (CDFA)

See OPS 1.430

1. Introduction
 - 1.1. Controlled-Flight-Into-Terrain (CFIT) is a major causal category of accident and hull loss in commercial aviation. Most CFIT accidents occur in the final approach segment of non-precision approaches; the use of stabilised-approach criteria on a continuous descent with a constant, predetermined vertical path is seen as a major improvement in safety during the conduct of such approaches. Operators should ensure that the following techniques are adopted as widely as possible, for all approaches.
 - 1.2. The elimination of level flight segments at Minimum Descent Altitude (MDA) close to the ground during approaches, and the avoidance of major changes in attitude and power / thrust close to the runway which can destabilise approaches, are seen as ways to reduce operational risks significantly.
 - 1.3. For completeness this AC also includes criteria which should be considered to ensure the stability of an approach (in terms of the aeroplane's energy and approach-path control).
 - 1.4. The term Continuous Descent Final Approach (CDFA) has been selected to cover a technique for any type of non-precision approach.
 - 1.5. Non-precision approaches operated other than using a constant pre-determined vertical path or when the facility requirements and associated conditions do not meet the conditions specified in Para 2.4 below RVR penalties apply. However, this should not preclude the operator from applying CDFA technique to such approaches. Those operations should be classified as special letdown procedures, since it has been shown that such operations, flown without additional training, may lead to inappropriately steep descent to the MDA(H), with continued descent below the MDA(H) in an attempt to gain (adequate) visual reference.
 - 1.6. The advantages of CDFA are:
 - a. The technique enhances safe approach operations by the utilisation of standard operating practices;
 - b. The profile reduces the probability of infringement of obstacle-clearance along the final approach segment and allows the use of MDA as DA;
 - c. The technique is similar to that used when flying an ILS approach, including when executing the missed approach and the associated go-around manoeuvre;
 - d. The aeroplane attitude may enable better acquisition of visual cues;
 - e. The technique may reduce pilot workload;
 - f. The Approach profile is fuel efficient;
 - g. The Approach profile affords reduced noise levels;
 - h. The technique affords procedural integration with APV approach operations;
 - i. When used and the approach is flown in a stabilised manner is the safest approach technique for all approach operations.
2. CDFA (Continuous Descent Final Approach)
 - 2.1. Continuous Descent Final Approach. A specific technique for flying the final approach segment of a non-precision instrument approach procedure as a continuous descent, without level-off, from an altitude/height at or above the final approach fix altitude/height to a point approximately 15m (50 ft) above the landing runway threshold or the point where the flare manoeuvre should begin for the type of aircraft flown.



2.2. An approach is only suitable for application of CDFA technique when it is flown along a predetermined vertical slope (see sub- paragraph a. below) which follows a designated or nominal vertical profile (see sub-paragraphs b. and c. below):

- a. Predetermined Approach Slope: Either the designated or nominal vertical profile of an approach.
 - i. Designated Vertical Profile: A continuous vertical approach profile which forms part of the approach procedure design. APV is considered to be an approach with a designated vertical profile.
 - ii. Nominal Vertical Profile: A vertical profile not forming part of the approach procedure design, but which can be flown as a continuous descent.

Note: The nominal vertical profile information may be published or displayed (on the approach chart) to the pilot by depicting the nominal slope or range / distance vs height.

Approaches with a nominal vertical profile are considered to be:

- a. NDB, NDB/DME;
- b. VOR, VOR/DME;
- c. LLZ, LLZ/DME;
- d. VDF, SRA or
- e. RNAV/LNAV.

2.3. Stabilised Approach (SAp). An approach which is flown in a controlled and appropriate manner in terms of configuration, energy and control of the flight path from a pre-determined point or altitude/height down to a point 50 feet above the threshold or the point where the flare manoeuvre is initiated if higher.

- a. The control of the descent path is not the only consideration when using the CDFA technique. Control of the aeroplane's configuration and energy is also vital to the safe conduct of an approach.
- b. The control of the flight path, described above as one of the requirements for conducting an SAp, should not be confused with the path requirements for using the CDFA technique. The pre-determined path requirements for conducting SAp are established by the operator and published in the Operations Manual (OM) Part B; guidance for conducting SAp operations is given in paragraph 5 below.
- c. The predetermined approach slope requirements for applying the CDFA technique are established by:
 - i. The instrument-procedure design when the approach has a designated vertical profile;
 - ii. The published 'nominal' slope information when the approach has a nominal vertical profile;
 - iii. The designated final-approach segment minimum of 3 NM, and maximum, when using timing techniques, of 8 NM.
- d. A Stabilised Approach will never have any level segment of flight at DA(H) (or MDA(H) as applicable). This enhances safety by mandating a prompt go-around manoeuvre at DA(H) (or MDA(H))
- e. An approach using the CDFA technique will always be flown as an SAp, since this is a requirement for applying CDFA; however, an SAp does not have to be flown using the CDFA technique, for example a visual approach.

2.4. Approach with a designated vertical profile using the CDFA technique:

- a. The optimum angle for the approach slope is 3 degrees, and the gradient should preferably not exceed 6.5 per cent which equates to a slope of 3.77 degrees, (400 ft/NM) for procedures intended for conventional aeroplane types/classes and/or operations. In any case, conventional approach slopes should be limited to 4.5 degrees for Category A and B aeroplanes and 3.77 degrees for



Category C and D aeroplanes, which are the upper limits for applying the CDFA technique. A 4.5 degree approach slope is the upper limit for certification of conventional aeroplanes.

- b. The approach is to be flown utilising operational flight techniques and onboard navigation system(s) and navigation aids to ensure it can be flown on the desired vertical path and track in a stabilised manner, without significant vertical path changes during the final-segment descent to the runway. APV is included.
- c. The approach is flown to a DA(H).
- d. No MAPt is published for these procedures.

2.5. Approach with a nominal vertical profile using the CDFA technique:

- a. The optimum angle for the approach slope is 3 degrees, and the gradient should preferably not exceed 6.5 per cent which equates to a slope of 3.77 degrees, (400 ft/NM) for procedures intended for conventional aeroplane types / class and / or operations. In any case, conventional approaches should be limited to 4.5 degrees for Category A and B aeroplanes and 3.77 degrees for Category C and D aeroplanes, which are the upper limits for applying CDFA technique. A 4.5 degree approach slope is the upper limit for certification of conventional aeroplanes.
- b. The approach should meet at least the following facility requirements and associated conditions. NDB, NDB/DME, VOR, VOR/DME, LLZ, LLZ/DME, VDF, SRA, RNAV(LNAV) with a procedure which fulfils the following criteria:
 - i. The final approach track off-set \leq 5degrees except for Category A and B aeroplanes, where the approach-track off-set is \leq 15 degrees; and
 - ii. A FAF, or another appropriate fix where descent is initiated is available; and
 - iii. The distance from the FAF to the THR is less than or equal to 8 NM in the case of timing; or
 - iv. The distance to the threshold (THR) is available by FMS/RNAV or DME; or
 - v. The minimum final-segment of the designated constant angle approach path should not be less than 3 NM from the THR unless approved by the Authority.
- c. CDFA may also be applied utilising the following:
 - i. RNAV/LNAV with altitude/height cross checks against positions or distances from the THR; or
 - ii. Height crosscheck compared with DME distance values.
- d. The approach is flown to a DA(H).
- e. The approach is flown as an SAp.

Note: Generally, a MAPt is published for these procedures.

3. Operational Procedures

- 3.1. A MAPt should be specified to apply CDFA with a nominal vertical profile as for any non-precision approach.
- 3.2. The flight techniques associated with CDFA employ the use of a predetermined approach slope. The approach, in addition, is flown in a stabilised manner, in terms of configuration, energy and control of the flight path. The approach should be flown to a DA(H) at which the decision to land or go-around is made immediately. This approach technique should be used when conducting:
 - a. All non-precision approaches (NPA) meeting the specified CDFA criteria in Para 2.4; and
 - b. All approaches categorised as APV.



- 3.3. The flight techniques and operational procedures prescribed above should always be applied; in particular with regard to control of the descent path and the stability of the aeroplane on the approach prior to reaching MDA(H). Level flight at MDA(H) should be avoided as far as practicable. In addition appropriate procedures and training should be established and implemented to facilitate the applicable elements of paragraphs 4, 5 and 8. Particular emphasis should be placed on subparagraphs 4.8, 5.1 to 5.7 and 8.4.
- 3.4. In cases where the CDFA technique is not used with high MDA(H), it may be appropriate to make an early descent to MDA(H) with appropriate safeguards to include the above training requirements, as applicable, and the application of a significantly higher RVR/Visibility.
- 3.5. For Circling Approaches (Visual Manoeuvring), all the applicable criteria with respect to the stability of the final descent path to the runway should apply. In particular, the control of the desired final nominal descent path to the threshold should be conducted to facilitate the techniques described in paragraphs 4 and 5 of this AC.
- a. Stabilisation during the final straight-in segment for a circling approach should ideally be accomplished by 1000 ft above aerodrome elevation for turbo-jet aeroplanes.
 - b. For a circling approach where the landing runway threshold and appropriate visual landing aids may be visually acquired from a point on the designated or published procedure (prescribed tracks), stabilisation should be achieved not later than 500 ft above aerodrome elevation. It is however recommended that the aeroplane be stabilised when passing 1000 ft above aerodrome elevation.
 - c. When a low-level final turning manoeuvre is required in order to align the aeroplane visually with the landing runway, a height of 300 ft above the runway threshold elevation, or aerodrome elevation as appropriate, should be considered as the lowest height for approach stabilisation with wings level.
 - d. Dependent upon aeroplane type/class the operator may specify an appropriately higher minimum stabilisation height for circling approach operations.
 - e. The operator should specify in the OM the procedures and instructions for conducting circling approaches to include at least:
 - i. The minimum required visual reference; and
 - ii. The corresponding actions for each segment of the circling manoeuvre; and
 - iii. The relevant go-around actions if the required visual reference is lost.
 - iv. The visual reference requirements for any operations with a prescribed track circling manoeuvre to include the MDA(H) and any published MAPt.
- 3.6. Visual Approach. All the applicable criteria with respect to the stability of the final descent path to the runway should apply to the operation of visual approaches. In particular, the control of the desired final nominal descent path to the threshold should be conducted to facilitate the appropriate techniques and procedures described in paragraphs 6 and 7 of this AC.
- a. Stabilisation during the final straight-in segment for a visual approach should ideally be accomplished by 500 ft above runway threshold elevation for turbo-jet aeroplanes.
 - b. When a low level final turning manoeuvre is required in order to align the aeroplane with the landing runway, a minimum height of 300 ft above the runway threshold elevation (or aerodrome elevation as appropriate) should be considered as the lowest height for visual approach stabilisation with wings level.
 - c. Dependent upon aeroplane type/class, the operator may specify an appropriately higher minimum stabilisation height for visual approach operations.
 - d. The operator should specify in the OM the procedures and instructions for conducting visual approaches to include at least:
 - i. The minimum required visual reference; and



- ii. The corresponding actions if the required visual reference is lost during a visual approach manoeuvre; and
 - iii. The appropriate go around actions.
- 3.7. The control of the descent path using the CDFA technique ensures that the descent path to the runway threshold is flown using either:
 - a. A variable descent rate or flight path angle to maintain the desired path, which may be verified by appropriate crosschecks; or
 - b. A pre-computed constant rate of descent from the FAF, or other appropriate fix which is able to define a descent point and/or from the final approach segment step-down fix; or
 - c. Vertical guidance, including APV.

The above techniques also support a common method for the implementation of flight-director-guided or auto-coupled RNAV(VNAV) or GLS approaches.
- 3.8. Missed Approach - The manoeuvre associated with the vertical profile of the missed approach should be initiated not later than reaching the MAPt or the DA(H) specified for the approach, whichever occurs first. The lateral part of the missed approach procedure must be flown via the MAPt unless otherwise stated on the approach chart.
- 3.9. In case the CDFA technique is not used the approach should be flown to an altitude/height at or above the MDA(H) where a level flight segment at or above MDA(H) may be flown to the MAPt.
- 3.10. In case the CDFA technique is not used when flying an approach, the operator should implement procedures to ensure that early descent to the MDA(H) will not result in a subsequent flight below MDA(H) without adequate visual reference. These procedures could include:
 - a. Awareness of radio altimeter information with reference to the approach profile;
 - b. Enhanced Ground Proximity Warning System and / or Terrain Awareness information;
 - c. Limitation of rate of descent;
 - d. Limitation of the number of repeated approaches;
 - e. Safeguards against too early descents with prolonged flight at MDA(H);
 - f. Specification of visual requirements for the descent from the MDA(H).
4. Flight techniques
 - 4.1. The CDFA technique can be used on almost any published non-precision approach when the control of the descent path is aided by either:
 - a. A recommended descent rate, based on estimated ground speed, which may be provided on the approach chart; or
 - b. The descent path as depicted on the chart.
 - 4.2. In order to facilitate the requirement of paragraph 4.1.b. above, the operator should either provide charts which depict the appropriate cross check altitudes/heights with the corresponding appropriate range information, or such information should be calculated and provided to the flight-crew in an appropriate and useable format.
 - 4.3. For approaches flown coupled to a designated descent path using computed electronic glideslope guidance (normally a 3 degree path), the descent path should be appropriately coded in the flight management system data base and the specified navigational accuracy (RNP) should be determined and maintained throughout the operation of the approach.



- 4.4. With an actual or estimated ground speed, a nominal vertical profile and required descent rate, the approach should be flown by crossing the FAF configured and on-speed. The tabulated or required descent rate is established and flown to not less than the DA(H), observing any step-down crossing altitudes if applicable.
- 4.5. To assure the appropriate descent path is flown, the pilot monitoring should announce crossing altitudes as published fixes and other designated points are crossed, giving the appropriate altitude or height for the appropriate range as depicted on the chart. The pilot flying should promptly adjust the rate of descent as appropriate.
- 4.6. With the required visual reference requirements established, the aeroplane should be in position to continue descent through the DA(H) or MDA(H) with little or no adjustment to attitude or thrust/power.
- 4.7. When applying CDFA on an approach with a nominal vertical profile to a DA(H), it may be necessary to apply an add-on to the published minima (vertical profile only) to ensure sufficient obstacle clearance. The add on, if applicable, should be published in the OM – (Aerodrome Operating Minima). However, the resulting procedure minimum will still be referred to as the DA(H) for the approach.
- 4.8. Operators should establish a procedure to ensure that an appropriate callout (automatic or oral) is made when the aeroplane is approaching DA(H). If the required visual references are not established at DA(H), the missed-approach procedure is to be executed promptly. Visual contact with the ground alone is not sufficient for continuation of the approach. With certain combinations of DA(H), RVR and approach slope, the required visual references may not be achieved at the DA(H) in spite of the RVR being at or above the minimum required for the conduct of the approach. The safety benefits of CDFA are negated if prompt go-around action is not initiated.
- 4.9. The following bracketing conditions in relation to angle of bank, rate of descent and thrust /power management are considered to be suitable for most aeroplane types/class to ensure the predetermined vertical path approach is conducted in a stabilised manner:
- Bank angle: As prescribed in the AOM, should generally be less than 30 degrees;
 - Rate of descent (ROD): The target ROD should not exceed 1000 fpm. The ROD should deviate by no more than + 300 feet per minute (fpm) from the target ROD. Prolonged rates of descent which differ from the target ROD by more than 300 fpm indicate that the vertical path is not being maintained in a stabilised manner. The ROD should not exceed 1200 fpm except under exceptional circumstances, which have been anticipated and briefed prior to commencing the approach; for example, a strong tailwind.
Note: Zero rate of descent may be used when the descent path needs to be regained from below the profile. The target ROD may need to be initiated prior to reaching the required descent point (typically 0.3 NM before the descent point, dependent upon ground speed, which may vary for each type/class of aeroplane). See c. below.
 - Thrust/power management: The limits of thrust/power and the appropriate range should be specified in the OM, Part B or equivalent documents
- 4.10. Transient corrections/ Overshoots: The above-specified range of corrections should normally be used to make occasional momentary adjustments in order to maintain the desired path and energy of the aeroplane. Frequent or sustained overshoots should require the approach to be abandoned and a go around initiated. A correction philosophy should be applied similar to that described in paragraph 5 below.
- 4.11. The relevant elements of paragraph 4 above should, in addition, be applied to approaches not flown using the CDFA technique; the procedures thus developed, thereby ensure a controlled flight path to MDA(H). Dependent upon the number of step down fixes and the aeroplane type/class, the aeroplane should be appropriately configured to ensure safe control of the flight path prior to the final descent to MDA(H).
5. Stabilisation of energy/speed and configuration of the aeroplane on the approach
- 5.1. The control of the descent path is not the only consideration. Control of the aeroplane's configuration and energy is also vital to the safe conduct of an approach.
- 5.2. The approach should be considered to be fully stabilised when the aeroplane is:
- tracking on the required approach path and profile; and



- b. in the required configuration and attitude; and
 - c. flying with the required rate of descent and speed; and
 - d. flying with the appropriate thrust/power and trim.
- 5.3. The following flight path control criteria should be met and maintained when the aeroplane passes the gates described in paragraphs 5.6 and 5.7 below.
- 5.4. The aeroplane is considered established on the required approach path at the appropriate energy for stable flight using the CDFA technique when:
- a. It is tracking on the required approach path with the correct track set, approach aids tuned and identified as appropriate to the approach type flown and on the required vertical profile; and
 - b. It is at the appropriate attitude and speed for the required target ROD with the appropriate thrust/power and trim.
- 5.5. It is recommended to compensate for strong wind/gusts on approach by speed increments given in the aeroplane Operations Manual (AOM) or equivalent document. To detect windshear and magnitude of winds aloft, all available aeroplane equipment such as FMS, INS, etc. should be used.
- 5.6. It is recommended that stabilisation during any straight-in approach without visual reference to the ground should be achieved at the latest when passing 1,000 ft above runway threshold elevation. For approaches with a designated vertical profile applying CDFA, a later stabilisation in speed may be acceptable if higher than normal approach speeds are required by ATC procedures or allowed by the OM. Stabilisation should, however, be achieved not later than 500 ft above runway threshold elevation.
- 5.7. For approaches where the pilot has visual reference with the ground, stabilisation should be achieved not later than 500 ft above aerodrome elevation. However, it is recommended that the aeroplane should be stabilised when passing 1,000 ft above runway threshold elevation.
- 5.8. The relevant elements of paragraph 5 above should in addition be applied to approaches not flown using the CDFA technique; the procedures thus developed ensure that a controlled and stable path to MDA(H) is achieved. Dependent upon the number of step down fixes and the aeroplane type/class, the aeroplane should be appropriately configured to ensure safe and stable flight prior to the final descent to MDA(H).
6. Visual Reference and path-control below MDA(H) when not using the CDFA technique
- 6.1. In addition to the requirements stated in Appendix 1 to OPS 1.430, the pilot should have attained a combination of visual cues to safely control the aeroplane in roll and pitch to maintain the final approach path to landing. This must be included in the standard operating procedures and reflected in the OM.
7. Operational Procedures and Instructions for using the CDFA technique or not.
- 7.1. The operator should establish procedures and instructions for flying approaches using the CDFA technique and not. These procedures should be included in the OM and should include the duties of the flight crew during the conduct of such operations.
- a. The operator should publish in the OM the requirements stated in paragraphs 4 and 5 above, as appropriate to the aeroplane type or class to be operated.
 - b. The checklists should be completed as early as practicable and preferably before commencing final descent towards the DA(H).
- 7.2. The operator's manuals should at least specify the maximum rate of descent for each aeroplane type/class operated and the required visual reference to continue the approach below:
- a. The DA(H) when applying CDFA;
 - b. MDA(H) when not applying CDFA.



- 7.3. The operator should establish procedures which prohibit level flight at MDA(H) without the flight crew having obtained the required visual references.

Note: It is not the intention of this paragraph to prohibit level flight at MDA(H) when conducting a circling approach, which does not come within the definition of the CDFA technique.

- 7.4. The operator should provide the flight crew with:

- a. Unambiguous details of the technique used (CDFA or not).
- b. The corresponding relevant minima should include:
 - i. Type of decision, whether DA(H) or MDA(H);
 - ii. MAPt as applicable;
 - iii. Appropriate RVR/Visibility for the approach classification and aeroplane category.

- 7.5. Specific types/class of aeroplane, in particular certain Performance Class B and Class C aeroplanes, may be unable to comply fully with the requirements of this AC relating to the operation of CDFA. This problem arises because some aeroplanes must not be configured fully into the landing configuration until required visual references are obtained for landing, because of inadequate missed approach performance engine out. For such aeroplanes, the operator should either:

- a. Obtain approval from the Authority for an appropriate modification to the stipulated procedures and flight techniques prescribed herein; or
- b. Increase the required minimum RVR to ensure the aeroplane will be operated safely during the configuration change on the final approach path to landing.

8. Training

- 8.1. The operator should ensure that, prior to using the CDFA technique or not (as appropriate), each flight crew member undertakes:

- a. The appropriate training and checking as required by Subpart N. Such training should cover the techniques and procedures appropriate to the operation which are stipulated in paragraphs 4 and 5 of this AC
- b. The operator's proficiency check should include at least one approach to a landing or go around as appropriate using the CDFA technique or not. The approach should be operated to the lowest appropriate DA(H) or MDA(H) as appropriate; and, if conducted in a Simulator, the approach should be operated to the lowest approved RVR.

Note. The approach required by paragraph 8.1.b. is not in addition to any manoeuvre currently required by either licensing regulations or OPS 1. The requirement may be fulfilled by undertaking any currently required approach (engine out or otherwise) other than a precision approach, whilst using the CDFA technique.

- 8.2. The policy for the establishment of constant predetermined vertical path and approach stability are to be enforced both during initial and recurrent pilot training and checking. The relevant training procedures and instructions should be documented in the OM.

- 8.3. The training should emphasise the need to establish and facilitate joint crew procedures and CRM to enable accurate descent path control and the requirement to establish the aeroplane in a stable condition as required by the operator's operational procedures. If barometric vertical navigation is used the crews should be trained in the errors associated with these systems.

- 8.4. During training emphasis should be placed on the flight crew's need to:

- a. Maintain situational awareness at all times, in particular with reference to the required vertical and horizontal profile;
- b. Ensure good communication channels throughout the approach;



- c. Ensure accurate descent-path control particularly during any manually-flown descent phase. The non-operating/non-handling pilot should facilitate good flight path control by:
 - i. Communicating any altitude/height crosschecks prior to the actual passing of the range/altitude or height crosscheck;
 - ii. Prompting, as appropriate, changes to the target ROD;
 - iii. Monitoring flight path control below DA/MDA.
 - d. Understand the actions to be taken if the MAPt is reached prior to the MDA(H).
 - e. Ensure that the decision to go around must, at the latest, have been taken upon reaching the DA(H) or MDA(H).
 - f. Ensure that prompt go around action is taken immediately when reaching DA(H) if the required visual reference has not been obtained as there may be no obstacle protection if the go-around manoeuvre is delayed.
 - g. Understand the significance of using the CDFA technique to a DA(H) with an associated MAPt and the implications of early go around manoeuvres.
 - h. Understand the possible loss of the required visual reference (due to pitch-change/climb) when not using the CDFA technique for aeroplane types/classes which require a late change of configuration and/or speed to ensure the aeroplane is in the appropriate landing configuration.
- 8.5. Additional specific training when not using the CDFA technique with level flight at or above MDA(H).
- a. The training should detail:
 - i. The need to facilitate good CRM; with good flight-crew communication in particular.
 - ii. The additional known safety risks associated with the 'dive-and-drive' approach philosophy which may be associated with non-CDFA.
 - iii. The use of DA(H) during approaches flown using the CDFA technique.
 - iv. The significance of the MDA(H) and the MAPt where appropriate.
 - v. The actions to be taken at the MAPt and the need to ensure the aeroplane remains in a stable condition and on the nominal and appropriate vertical profile until the landing.
 - vi. The reasons for increased RVR/Visibility minima when compared to the application of CDFA.
 - vii. The possible increased obstacle infringement risk when undertaking level flight at MDA(H) without the required visual references.
 - viii. The need to accomplish a prompt go around manoeuvre if the required visual reference is lost.
 - ix. The increased risk of an unstable final approach and an associated unsafe landing if a rushed approach is attempted either from:
 - a. Inappropriate and close-in acquisition of the required visual reference;
 - b. Unstable aeroplane energy and or flight path control.
 - x. The increased risk of CFIT (see introduction).
9. Approvals
- 9.1. The procedures which are flown with level flight at/or above MDA(H) must be approved by the Authority and listed in the OM.



- 9.2. Operators should classify aerodromes where there are approaches which require level flight at/or above MDA(H) as being B and C categorised. Such aerodrome categorisation will depend upon the operator's experience, operational exposure, training programme(s) and flight crew qualification(s).
- 9.3. Exemptions granted in accordance with OPS 1.430, paragraph (d)(3) should be limited to locations where there is a clear public interest to maintain current operations. The exemptions should be based on the operators experience, training programme and flight crew qualification. The exemptions should be reviewed at regular intervals and should be terminated as soon as facilities are improved to allow SAP or CDFA.

AMC OPS 1.430

Documents Containing Information Related to All Weather Operations

See OPS 1, Subpart E

- 1 The purpose of this AMC is to provide operators with a list of documents related to AWO.
 - a. ICAO Annex 2 / Rules of the Air;
 - b. ICAO Annex 6 / Operation of Aircraft, Part I;
 - c. ICAO Annex 10 / Telecommunications Vol 1;
 - d. ICAO Annex 14 / Aerodromes Vol 1;
 - e. ICAO Doc 8186 / PANS - OPS Aircraft Operations;
 - f. ICAO Doc 9365 / AWO Manual;
 - g. ICAO Doc 9476 / SMGCS Manual (Surface Movement Guidance And Control Systems);
 - h. ICAO Doc 9157 / Aerodrome Design Manual;
 - i. ICAO Doc 9328 / Manual for RVR Assessment;
 - j. ECAC Doc 17, Issue 3 (partly incorporated in OPS); and
 - k. EASA CS-AWO (Airworthiness Certification).

AMC to Appendix 1 to OPS 1.430 Table 6a

Effect on Landing Minima of Temporarily Failed or Downgraded Ground Equipment

See Appendix 1 to OPS 1.430 Table 6a

1. Introduction
 - 1.1 This AMC provides operators with instructions for flight crews on the effects on landing minima of temporary failures or downgrading of ground equipment.
 - 1.2 Aerodrome facilities are expected to be installed and maintained to the standards prescribed in ICAO Annexes 10 and 14. Any deficiencies are expected to be repaired without unnecessary delay.
2. General. These instructions are intended for use both pre-flight and in-flight. It is not expected however that the commander would consult such instructions after passing the outer marker or equivalent position. If failures of ground aids are announced at such a late stage, the approach could be continued at the commander's discretion.

If, however, failures are announced before such a late stage in the approach, their effect on the approach should be considered as described in Tables 1A and 1B below, and the approach may have to be abandoned to allow this to happen.

Note: Tables 1A and 1B below are copied from Appendix 1 to OPS 1.430 Table 6a.

3. Operations with no Decision Height (DH)
 - 3.1 The operator should ensure that, for aeroplanes authorised to conduct no DH operations with the lowest RVR limitations, the following applies in addition to the content of Tables 1A and 1B, below:
 - a. RVR. At least one RVR value must be available at the aerodrome;
 - b. Runway lights
 - i. No runway edge lights, or no centre lights – Day – RVR 200 m; Night – Not allowed;
 - ii. No TDZ lights – No restrictions;



- iii. No standby power to runway lights – Day – RVR 200 m; Night – not allowed.
4. Conditions applicable to Tables 1A & 1B
- a. Multiple failures of runway lights other than indicated in Table 1B are not acceptable.
 - b. Deficiencies of approach and runway lights are treated separately.
 - c. Category II or III operations. A combination of deficiencies in runway lights and RVR assessment equipment is not allowed.
 - d. Failures other than ILS affect RVR only and not DH.



This Page Intentionally Left Blank



TABLE 1A - Failed or Downgraded Equipment - Effect on Landing Minima

FAILED OR DOWNGRADED EQUIPMENT	EFFECT ON LANDING MINIMA				
	CAT III B (: 1)	CAT III A	CAT II	CAT I	NON PRECISION
ILS stand-by transmitter	Not allowed		No effect		
Outer Marker	No effect if replaced by published equivalent position				Not applicable
Middle Marker	No effect				No effect unless used as MAPT
Touch Down Zone RVR assessment system	May be temporarily replaced with midpoint RVR if approved by the State of the aerodrome. RVR may be reported by human observation			No effect	
Midpoint or Stopend RVR	No effect				
Anemometer for R/W in use	No effect if other ground source available				
Celiometer	No effect				

Note 1: For Cat III B operations with no DH, see also paragraph 3, above.



TABLE 1B - Failed or Downgraded Equipment - Effect on Landing Minima

FAILED OR DOWNGRADED EQUIPMENT	EFFECT ON LANDING MINIMA				
	CAT III B (Note 1)	CAT III A	CAT II	CAT I	NON PRECISION
Approach lights	Not allowed for operations with DH > 50 ft		Not allowed	Minima as for nil facilities	
Approach lights except the last 210 m	No effect		Not allowed	Minima as for nil facilities	
Approach lights except the last 420 m	No effect			Minima as for intermediate facilities	
Standby power for approach lights	No effect				No effect
Whole runway light system	Not allowed			Day - Minima as for nil facilities Night - Not allowed	
Edge lights	Day only; Night - not allowed				
Centreline lights	Day - RVR 300 m Night - not allowed		Day - RVR 300 m Night - 550 m	No effect	
Centreline lights spacing increased to 30 m	RVR 150 m	No effect			
Touch Down Zone lights	Day - RVR 200 m Night - 300 m	Day - RVR 300 m Night - 550 m		No effect	
Standby power for runway lights	Not allowed			No effect	
Taxiway light system	No effect - except delays due to reduced movement rate				

Note: For Cat III B operations with no DH, see also paragraph 3 above.



**AC OPS to Appendix 1 to OPS 1.430(d)
Aerodrome Operating Minima
Determination of RVR / Visibility Minima for Category I, APV and Non-precision Approaches**

1. Introduction
 - 1.1. The minimum RVR values for the conduct of Category I, APV and non-precision approaches shall be the higher of the values derived from Table 5 or 6 of Appendix 1 to OPS 1.430.
 - 1.2. The tables are to be used for the determination of all applicable operational RVR values except as prescribed in paragraph 1.3 below.
 - 1.3. With the approval of the Authority, the formula below may be used with the actual approach slope and or the actual length of the approach lights for a particular runway. This formula may also be used with the approval of the Authority to calculate the applicable RVR for special (one-off) approach operations which are allowed under OPS 1.430(d)(2).
 - 1.4. When the formula is utilised as described above, the calculation conventions and methodologies described in the notes applicable to Paragraph 2 below should be used.

2. Derivation of Minimum RVR Values.

- 2.1. The values in Table 5 in Appendix 1 to OPS 1.430 are derived from the formula below:

$$\text{Required RVR/Visibility (m)} = \frac{\text{DH/MDH (ft)} \times 0.3048 - \text{length of approach lights (m)}}{\tan \alpha}$$

- Note 1: α is the calculation angle, being a default value of 3.00 degrees increasing in steps of 0.10 degrees for each line in Table 5 up to 3.77 degrees and then remains constant.*
- Note 2: The default value for the length of the approach lights is equal to the minimum length of the various systems described in Table 4 in Appendix 1 to OPS 1.430.*
- Note 3: The values derived from the above formula have been rounded to the nearest 50 metres up to a value of 800 metres RVR and thereafter to the nearest 100 metres.*
- Note 4: The DH/MDH intervals in Table 5 have been selected to avoid anomalies caused by the rounding of the calculated OCA(H).*
- Note 5: The height intervals, referred in Note 4 above, are 10 feet up to a DH/MDH of 300 feet, 20 feet up to a DH/MDH of 760 feet and then 50 feet for DH/MDH above 760 feet.*
- Note 6: The minimum value of the table is 550 metres.*

- 2.2. With the approval of the Authority, the formula may be used to calculate the applicable RVR value for approaches with approach-slopes of greater than 4.5 degrees.
3. Approach Operations with an RVR of less than 750m (800m for single-pilot operations)
 - 3.1. Providing the DH is not more than 200 ft, approach operations are almost unrestricted with a runway which is equipped with FALS, RTZL and RCLL. Under these circumstances, the applicable RVR of less than 750m (800m for single-pilot operations) may be taken directly from Table 5. The ILS should not be promulgated as restricted in AIPs, NOTAMS or other documents. Unacceptable ILS restrictions would include limitations on the use of the Localizer and / or glideslope below a certain height, prohibitions on its use auto-coupled or limitations on the ILS classification.
 - 3.2. Without RTZL and RCLL in order to be able to operate to the RVR values of less than 750m (800m for single-pilot operations) in Table 5, the approach must be conducted utilising an approved HUDLS (or equivalent approved system), or be flown as a coupled approach or flight-director-flown approach (Note: not for single-pilot operations) to a DH of not greater than 200 ft.



The equivalent system could for instance be an approved HUD which is not certificated as a landing system but is able to provide adequate guidance cues. Other devices may also be suitable, such as Enhanced/Synthetic Vision Systems (E/SVS) or other hybrids of such devices.

4. Description of Approach Lighting Systems

4.1. The following table describes the types of approach lighting systems which are acceptable for calculation of the aerodrome operating minima. The systems described are basically the ICAO systems as described in Annex 14. However, the table also contains shorter systems which are acceptable for operational use. This is concurrent with the fact that approach lighting systems may sometimes be adjusted to the conditions existing before the threshold. Additionally the table describes the FAA approach lighting systems which are considered to be corresponding for calculation of aerodrome operating minima.

OPS 1 Class of Facility	Length, configuration and intensity of approach lights
FALS (Full Approach Light System)	Precision approach category I lighting system as specified in Annex 14, high intensity lights, 720 m or more FAA: ALSF1, AL
IALS (Intermediate Approach Light System)	OPS1/EASA: Simplified Approach Light System as specified in Annex 14, high intensity lights, 420 – 719 m FAA: MALSF, MALS, SALS/SALSF, SSALF, SSALS, high or medium intensity and/or flashing lights, 420 – 719 m
BALS (Basic Approach Light System)	OPS 1/EASA: High, medium or low intensity lights, 210 - 419 m including one crossbar FAA: ODALS, high or medium intensity or flashing lights 210 - 419 m
NALS (No Approach Light System)	OPS 1/EASA: Approach Light System shorter than 210 m or no approach lights

**AMC to Appendix 1 to OPS 1.430, paragraphs (e) and (f)
Establishment of Minimum RVR for Category II and III Operations
See Appendix 1 to OPS 1.430, paragraphs (f) and (g)**

1. General
 - 1.1. When establishing minimum RVR for Category II and III Operations, operators should pay attention to the following information which originates in ECAC Doc 17 3rd Edition, Subpart A. It is retained as background information and, to some extent, for historical purposes although there may be some conflict with current practices.
 - 1.2. Since the inception of precision approach and landing operations various methods have been devised for the calculation of aerodrome operating minima in terms of decision height and runway visual range. It is a comparatively straightforward matter to establish the decision height for an operation but establishing the minimum RVR to be associated with that decision height so as to provide a high probability that the required visual reference will be available at that decision height has been more of a problem.
 - 1.3. The methods adopted by various States to resolve the DH/RVR relationship in respect of Category II and Category III operations have varied considerably. In one instance there has been a simple approach which entailed the application of empirical data based on actual operating experience in a particular environment. This has given satisfactory results for application within the environment for which it was developed. In another instance a more sophisticated method was employed which utilised a fairly complex computer programme to take account of a wide range of variables. However, in the latter case, it has been found that with the improvement in the performance of visual aids, and the increased use of automatic equipment in the many different types of new aircraft, most of the variables cancel each other out and a simple tabulation can be constructed which is applicable to a wide range of aircraft. The basic principles which are observed in establishing the values in such a table are that the scale of visual reference required by a pilot at and below decision height depends on the task that he has to carry out, and that the degree to which his vision is obscured depends on the obscuring medium, the general rule in fog being that it becomes more dense with increase in height. Research using flight simulators coupled with flight trials has shown the following:



- a. Most pilots require visual contact to be established about 3 seconds above decision height though it has been observed that this reduces to about 1 second when a fail-operational automatic landing system is being used;
 - b. To establish lateral position and cross-track velocity most pilots need to see not less than a 3 light segment of the centre line of the approach lights, or runway centre line, or runway edge lights;
 - c. For roll guidance most pilots need to see a lateral element of the ground pattern, i.e. an approach lighting cross bar, the landing threshold, or a barrette of the touchdown zone lighting; and
 - d. To make an accurate adjustment to the flight path in the vertical plane, such as a flare, using purely visual cues, most pilots need to see a point on the ground which has a low or zero rate of apparent movement relative to the aircraft.
 - e. With regard to fog structure, data gathered in the United Kingdom over a twenty-year period have shown that in deep stable fog there is a 90% probability that the slant visual range from eye heights higher than 15ft above the ground will be less than the horizontal visibility at ground level, i.e. RVR. There are at present no data available to show what the relationship is between the Slant Visual Range and RVR in other low visibility conditions such as blowing snow, dust or heavy rain, but there is some evidence in pilot reports that the lack of contrast between visual aids and the background in such conditions can produce a relationship similar to that observed in fog.
2. Category II Operations
- 2.1. The selection of the dimensions of the required visual segments which are used for Category II operations is based on the following visual requirements:
- a. A visual segment of not less than 90 metres will need to be in view at and below decision height for pilot to be able to monitor an automatic system;
 - b. A visual segment of not less than 120 metres will need to be in view for a pilot to be able to maintain the roll attitude manually at and below decision height; and
 - c. For a manual landing using only external visual cues, a visual segment of 225 metres will be required at the height at which flare initiation starts in order to provide the pilot with sight of a point of low relative movement on the ground.
3. Category III fail-passive operations
- 3.1. Category III operations utilising fail-passive automatic landing equipment were introduced in the late 1960's and it is desirable that the principles governing the establishment of the minimum RVR for such operations be dealt with in some detail.
- 3.2. During an automatic landing the pilot needs to monitor the performance of the aircraft system, not in order to detect a failure which is better done by the monitoring devices built into the system, but so as to know precisely the flight situation. In the final stages he should establish visual contact and, by the time he reaches decision height, he should have checked the aircraft position relative to the approach or runway centre-line lights. For this he will need sight of horizontal elements (for roll reference) and part of the touchdown area. He should check for lateral position and cross-track velocity and, if not within the pre-stated lateral limits, he should carry out a go-around. He should also check longitudinal progress and sight of the landing threshold is useful for this purpose, as is sight of the touchdown zone lights.
- 3.3. In the event of a failure of the automatic flight guidance system below decision height, there are two possible courses of action; the first is a procedure which allows the pilot to complete the landing manually if there is adequate visual reference for him to do so, or to initiate a go-around if there is not; the second is to make a go-around mandatory if there is a system disconnect regardless of the pilot's assessment of the visual reference available.
- a. If the first option is selected then the overriding requirement in the determination of a minimum RVR is for sufficient visual cues to be available at and below decision height for the pilot to be able to carry out a manual landing. Data presented in Doc 17 showed that a minimum value of 300 metres would give a high probability that the cues needed by the pilot to assess the aircraft in pitch and roll will be available and this should be the minimum RVR for this procedure.



- b. The second option, to require a go-around to be carried out should the automatic flight-guidance system fail below decision height, will permit a lower minimum RVR because the visual reference requirement will be less if there is no need to provide for the possibility of a manual landing. However, this option is only acceptable if it can be shown that the probability of a system failure below decision height is acceptably low. It should be recognised that the inclination of a pilot who experiences such a failure would be to continue the landing manually but the results of flight trials in actual conditions and of simulator experiments show that pilots do not always recognise that the visual cues are inadequate in such situations and present recorded data reveal that pilots' landing performance reduces progressively as the RVR is reduced below 300 metres. It should further be recognised that there is some risk in carrying out a manual go-around from below 50ft in very low visibility and it should therefore be accepted that if an RVR lower than 300 metres is to be authorised, the flight deck procedure should not normally allow the pilot to continue the landing manually in such conditions and the aeroplane system should be sufficiently reliable for the go around rate to be low.
- 3.4. These criteria may be relaxed in the case of an aircraft with a fail-passive automatic landing system which is supplemented by a head-up display which does not qualify as a fail-operational system but which gives guidance which will enable the pilot to complete a landing in the event of a failure of the automatic landing system. In this case it is not necessary to make a go-around mandatory in the event of a failure of the automatic landing system when the RVR is less than 300 metres.
4. Category III fail-operational operations - with a Decision Height
 - 4.1. For Category III operations utilising a fail-operational landing system with a Decision Height, a pilot should be able to see at least 1 centre line light.
 - 4.2. For Category III operations utilising a fail-operational hybrid landing system with a Decision Height, a pilot should have a visual reference containing a segment of at least 3 consecutive lights of the runway centre line lights.
 5. Category III fail-operational operations - with No Decision Height
 - 5.1. For Category III operations with No Decision Height the pilot is not required to see the runway prior to touchdown. The permitted RVR is dependent on the level of aeroplane equipment.
 - 5.2. A CAT III runway may be assumed to support operations with no Decision Height unless specifically restricted as published in the AIP or NOTAM.

AMC to Appendix 1 to OPS 1.430, paragraph (f)(4)

Crew Actions in Case of Autopilot Failure at or below Decision Height in Fail-passive Category III Operations. See Appendix 1 to OPS 1.430, paragraph (f)(4)

For operations to actual RVR values less than 300m, a go-around is assumed in the event of an autopilot failure at or below DH. This means that a go-around is the normal action. However the wording recognises that there may be circumstances where the safest action is to continue the landing. Such circumstances include the height at which the failure occurs, the actual visual references, and other malfunctions. This would typically apply to the late stages of the flare.

In conclusion it is not forbidden to continue the approach and complete the landing when the commander or the pilot to whom the conduct of the flight has been delegated, determines that this is the safest course of action. Operational instructions should reflect the information given in this AMC and the operator's policy.

AC OPS to Appendix 1 to OPS 1.430(g)

Enhanced Vision Systems

1. Introduction
 - 1.1. Enhanced vision systems use sensing technology to improve a pilot's ability to detect objects, such as runway lights or terrain, which may otherwise not be visible. The image produced from the sensor and/or image processor can be displayed to the pilot in a number of ways including use of a head-up display. The systems can be used in all phases of flight and can improve situational awareness. In particular, infrared systems can display terrain during operations at night, improve situational awareness during night and low visibility taxiing, and may allow earlier acquisition of visual references during instrument approaches.



2. Background to EVS rule
 - 2.1. The rule for EVS was developed after an operational evaluation of two different EVS systems, along with data and support kindly provided by the FAA. Approaches using EVS were flown in a variety of conditions including fog, rain and snow showers, as well as at night to aerodromes located in mountainous terrain. The infrared EVS performance can vary depending on the weather conditions encountered. Therefore, the Rule takes a conservative approach to cater for the wide variety of conditions which may be encountered. It may be necessary to amend the Rule in future to take account of greater operational experience.
 - 2.2. A rule for the use of EVS during take-off has not been developed. The systems evaluated did not perform well when the RVR was below 300 metres. There may be some benefit for use of EVS during take-off with greater visibility and reduced lighting; however, such operations would need to be evaluated.
 - 2.3. The Rule has been developed to cover use of infrared systems only. Other sensing technologies are not intended to be excluded; however, their use will need to be evaluated to determine the appropriateness of this, or any other rule. During the development of the Rule material in OPS 1.430 (h), it was envisaged what equipment should be fitted to the aeroplane, as a minimum. Given the present state of technological development, it is considered that a HUD is an essential element of the EVS equipment.
 - 2.4. In order to avoid the need for tailored charts for approaches utilising EVS, it is envisaged that the operator will use Table 9 to determine the applicable RVR at the commencement of the approach.
3. Additional Operational requirements
 - 3.1. An enhanced vision system equipment certificated for the purpose of Appendix 1 to OPS 1.403(h) should have:
 - a. A head-up display system (capable of displaying, airspeed, vertical speed, aircraft attitude, heading, altitude, command guidance as appropriate for the approach to be flown, path deviation indications, flight path vector, and flight path angle reference cue and the EVS imagery),
 - b. For two-pilot operation, a head-down view of the EVS image, or other means of displaying the EVS-derived information easily to the pilot monitoring the progress of the approach.

Note: If the aircraft is equipped with a radio altimeter, it will be used only as enhanced terrain awareness during approach using EVS and will be not taken into account for the operational procedures development
4. Two-pilot operations
 - 4.1. For operations in RVRs below 550 m, two-pilot operation will be required.
 - 4.2. The requirement for a head-down view of the EVS image is intended to cover for multi-pilot philosophy, whereby the pilot monitoring (PM) is kept in the 'loop' and CRM does not break down. The PM can be very isolated from the information necessary for monitoring flight progress and decision making if the PF is the only one to have the EVS image.

AC to Appendix 1 to OPS 1.430, paragraph (i)

Terminology: XLS = ILS/MLS/GLS etc.

Visual Manoeuvring (Circling)

1. The purpose of this AC is to provide operators with supplemental information regarding the application of aerodrome operating minima in relation to circling approaches.
2. Conduct of flight – General
 - 2.1. The Minimum Descent Height (MDH) and Obstacle Clearance Height (OCH) included in the procedure are referenced to aerodrome elevation.
 - 2.2. The Minimum Descent Altitude (MDA) is referenced to mean sea level.
 - 2.3. For these procedures, the applicable visibility is the meteorological visibility (VIS).
3. Instrument approach followed by visual manoeuvring (circling) without prescribed tracks



- 3.1. When the aeroplane is on the initial instrument approach, before visual reference is stabilised, but not below MDH/MDA - the aeroplane should follow the corresponding instrument approach procedure until the appropriate instrument Missed Approach Point (MAPt) is reached.
- 3.2. At the beginning of the level flight phase at or above the MDH/MDA, the instrument approach track determined by radio navigation aids, RNAV, RNP or XLS should be maintained until:
 - a. The pilot estimates that, in all probability, visual contact with the runway of intended landing or the runway environment will be maintained during the entire circling procedure; and
 - b. The pilot estimates that the aeroplane is within the circling area before commencing circling; and
 - c. The pilot is able to determine the aeroplane's position in relation to the runway of intended landing with the aid of the appropriate external references.
- 3.3. When reaching the published instrument MAPt and the conditions stipulated in paragraph 3.2 above, are unable to be established by the pilot, a missed approach should be carried out in accordance with that instrument approach procedure. See paragraph 5.
- 3.4. After the aeroplane has left the track of the initial (letdown) instrument approach, the flight phase outbound from the runway should be limited to an appropriate distance, which is required to align the aeroplane onto the final approach. Such manoeuvres should be conducted to enable the aeroplane:
 - a. To attain a controlled and stable descent path to the intended landing runway; and
 - b. Remain within the circling area and in such way that visual contact with the runway of intended landing or runway environment is maintained at all times.
- 3.5. Flight manoeuvres should be carried out at an altitude/height that is not less than the circling MDH/MDA.
- 3.6. Descent below MDH/MDA should not be initiated until the threshold of the runway to be used has been appropriately identified and the aeroplane is in a position to continue with a normal rate of descent and land within the touchdown zone.
4. Instrument approach followed by a visual manoeuvring (circling) with prescribed track
 - 4.1. The aeroplane should remain on the initial instrument approach or letdown procedure until one of the following is reached:
 - a. The prescribed divergence point to commence circling on the prescribed track; or
 - b. The appropriate initial instrument MAPt.
 - 4.2. The aeroplane should be established on the instrument approach track determined by the radio navigation aids, RNAV, RNP, or XLS in level flight at or above the MDH/MDA at or by the circling manoeuvre divergence point.
 - 4.3. If the divergence point is reached before the required visual reference is acquired, a missed approach should be initiated not later than the initial instrument approach MAPt and completed in accordance with the initial instrument approach procedure.
 - 4.4. When commencing the prescribed track-circling manoeuvre at the published divergence point, the subsequent manoeuvres should be conducted to comply with the published routing and promulgated heights/altitudes.
 - 4.5. Unless otherwise specified, once the aeroplane is established on the prescribed track(s), the promulgated visual reference should not be required to be maintained unless:
 - a. Required by the Authority;
 - b. The Circling MAPt (if published) is reached.
 - 4.6. If the prescribed track-circling manoeuvre has a published MAPt and the required visual reference has not been obtained a missed approach should be executed in accordance with paragraphs 5.2 and 5.3 below.



- 4.7. Subsequent further descent below MDH/MDA should only commence when the required visual reference is obtained.
- 4.8. Unless otherwise specified in the procedure, final descent should not be initiated from MDH/MDA until the threshold of the intended landing runway has been appropriately identified and the aeroplane is in a position to continue with a normal rate of descent and land within the touchdown zone.
5. Missed approach
- 5.1. Missed Approach during Instrument Approach prior to Circling
- If the decision to carry out a missed approach is taken when the aeroplane is positioned on the instrument approach track defined by radio-navigation aids RNAV, RNP, or XLS, and before commencing the circling manoeuvre, the published missed approach for the instrument approach should be followed.
 - If the instrument approach procedure is carried out with the aid of an XLS or Stabilised Approach (SAp), the (MAPt) associated with an XLS procedure without glide path (GP out procedure) or the SAp, where applicable, should be used.
- 5.2. If a prescribed missed approach is published for the circling manoeuvre, this overrides the manoeuvres prescribed below.
- 5.3. If visual reference is lost while circling to land after the aeroplane has departed from the initial instrument approach track, the missed approach specified for that particular instrument approach should be followed. It is expected that the pilot will make an initial climbing turn toward the intended landing runway and continue overhead the aerodrome where the pilot will establish the aeroplane in a climb on the instrument missed approach track.
- 5.4. The aeroplane should not leave the visual manoeuvring (circling) area, which is obstacle protected, unless:
- Established on the appropriate missed approach track; or
 - At Minimum Sector Altitude (MSA)
- 5.5. All turns should (see Note 1 below) be made in the same direction and the aeroplane should remain within the circling protected area while climbing to either:
- The altitude assigned to any published circling missed approach manoeuvre if applicable;
 - The altitude assigned to the missed approach of the initial instrument approach;
 - The Minimum Sector Altitude (MSA);
 - The Minimum Holding Altitude (MHA) applicable for transition to a holding facility or fix, or continue to climb to a Minimum Safe Altitude; or
 - As directed by ATS (C).
- Note: 1. When the go-around is commenced on the "downwind" leg of the circling manoeuvre, an "S" turn may be undertaken to align the aeroplane on the initial instrument approach missed approach path, provided the aeroplane remains within the protected circling area.*
- Note: 2. The commander should be responsible for ensuring adequate terrain clearance during the above-stipulated manoeuvres, particularly during the execution of a missed approach initiated by ATS.*
- 5.6. In as much as the circling manoeuvre may be accomplished in more than one direction, different patterns will be required to establish the aeroplane on the prescribed missed approach course depending on its position at the time visual reference is lost. In particular, all turns are to be in the prescribed direction if this is restricted, e.g. to the west/east (left or right hand) to remain within the protected circling area.



- 5.7. If a missed approach procedure is promulgated for the runway (XX) onto which the aeroplane is conducting a circling approach and the aeroplane has commenced a manoeuvre to align with the runway; the missed approach for this direction may be accomplished. The ATS should be informed of the intention to fly the promulgated missed approach procedure for runway XX.
- 5.8. When the option described in paragraph 5.7 above is undertaken the commander should whenever possible, advise at the earliest opportunity, the ATS(C) of the intended go around procedure. This dialogue should, if possible occur during the initial approach phase and include the intended missed approach to be flown and the level off altitude.
- 5.9. In addition to 5.8 above, the commander should advise ATS(C) when any go around has commenced the height / altitude the aeroplane is climbing to and the position the aeroplane is proceeding towards and or heading the aeroplane is established on.

AC to Appendix 1 to OPS 1.440
Operational Demonstrations
See Appendix 1 to OPS 1.440

1. General
 - 1.1 Demonstrations may be conducted in line operations, or any other flight where the operator's procedures are being used.
 - 1.2 In unique situations where the completion of 100 successful landings could take an unreasonably long period of time due to factors such as a small number of aeroplanes in the fleet, limited opportunity to use runways having Category II/III procedures, or inability to obtain ATS sensitive area protection during good weather conditions, and equivalent reliability assurance can be achieved, a reduction in the required number of landings may be considered on a case-by-case basis. Reduction of the number of landings to be demonstrated requires a justification for the reduction, and prior approval from Authority. However, at the operator's option, demonstrations may be made on other runways and facilities. Sufficient information should be collected to determine the cause of any unsatisfactory performance (e.g. sensitive area was not protected).
 - 1.3 If the operator has different variants of the same type of aeroplane utilising the same basic flight control and display systems, or different basic flight control and display systems on the same type/classes of aeroplane, the operator should show that the various variants have satisfactory performance, but the operator need not conduct a full operational demonstration for each variant.
 - 1.4 Not more than 30% of the demonstration flights should be made on the same runway.
2. Data Collection For Operational Demonstrations
 - 2.1 Data should be collected whenever an approach and landing is attempted utilising the Category II/ III system, regardless of whether the approach is abandoned, unsatisfactory, or is concluded successfully.
 - 2.2 The data should, as a minimum, include the following information:
 - a. Inability to initiate an Approach. Identify deficiencies related to airborne equipment which preclude initiation of a Category II/III approach.
 - b. Abandoned Approaches. Give the reasons and altitude above the runway at which approach was discontinued or the automatic landing system was disengaged.
 - c. Touchdown or Touchdown and Roll-out Performance. Describe whether or not the aircraft landed satisfactorily (within the desired touchdown area) with lateral velocity or cross track error which could be corrected by the pilot or automatic system so as to remain within the lateral confines of the runway without unusual pilot skill or technique. The approximate lateral and longitudinal position of the actual touchdown point in relation to the runway centreline and the runway threshold, respectively, should be indicated in the report. This report should also include any Category II/III system abnormalities which required manual intervention by the pilot to ensure a safe touchdown or touchdown and roll-out, as appropriate.
3. Data Analysis
 - 3.1 Unsuccessful approaches due to the following factors may be excluded from the analysis:



- a. ATS Factors. Examples include situations in which a flight is vectored too close to the final approach fix/point for adequate Localizer and glide slope capture, lack of protection of ILS sensitive areas, or ATS requests the flight to discontinue the approach.
- b. Faulty Navaid Signals. Navaid (e.g. ILS Localizer) irregularities, such as those caused by other aircraft taxiing, over-flying the navaid (antenna).
- c. Other Factors. Any other specific factors that could affect the success of Category II/III operations that are clearly discernible to the flight crew should be reported.

AMC to Appendix 1 to OPS 1.440, paragraph (b)
Criteria for a Successful CAT II/III Approach and Automatic Landing
See Appendix 1 to OPS 1.440, paragraph (b)

1. The purpose of this AMC is to provide operators with supplemental information regarding the criteria for a successful approach and landing to facilitate fulfilling the requirements prescribed in Appendix 1 to OPS 1.440, paragraph (b).
2. An approach may be considered to be successful if:
 - 2.1 From 500 feet to start of flare:
 - a. Speed is maintained as specified in AC-AWO 231, paragraph 2 'Speed Control'; and
 - b. No relevant system failure occurs; and
 - 2.2 From 300 feet to DH:
 - a. No excess deviation occurs; and
 - b. No centralised warning gives a go-around command (if installed).
3. An automatic landing may be considered to be successful if:
 - a. No relevant system failure occurs;
 - b. No flare failure occurs;
 - c. No de-crab failure occurs (if installed);
 - d. Longitudinal touchdown is beyond a point on the runway 60 metres after the threshold and before the end of the touchdown zone lighting (900 metres from the threshold);
 - e. Lateral touchdown with the outboard landing gear is not outside the touchdown zone lighting edge;
 - f. Sink rate is not excessive;
 - g. Bank angle does not exceed a bank angle limit; and
 - h. No roll-out failure or deviation (if installed) occurs.
4. More details can be found in EASA CS-AWO.

AMC to Appendix 1 to OPS 1.450(g)(1)
Low Visibility Operations - Training & Qualifications
See Appendix 1 to OPS 1.450

The number of approaches referred to in Appendix 1 to OPS 1.450(g)(1) includes one approach and landing that may be conducted in the aeroplane using approved Category II/III procedures. This approach and landing may be conducted in normal line operation or as a training flight. It is assumed that such flights will only be conducted by pilots qualified in accordance Appendix 1 to OPS 1.450 and OPS 1.940 and qualified for the particular category of operation.



This Page Intentionally Left Blank

**AC/AMC F****PERFORMANCE GENERAL****AMC OPS 1.475(b)****Landing - Reverse Thrust Credit****See OPS 1.475(b)**

Landing distance data included in the AFM (or POH etc.) with credit for reverse thrust can only be considered to be approved for the purpose of showing compliance with the applicable requirements if it contains a specific statement from the appropriate airworthiness authority that it complies with a recognised airworthiness code (e.g. FAR 23/25, EASA 23/25).

AC OPS 1.475(b)**Factoring of Automatic Landing Distance Performance Data (Performance Class A Aeroplanes only)****See OPS 1.475(b)**

1. In those cases where the landing requires the use of an automatic landing system, and the distance published in the Aeroplane Flight Manual (AFM) includes safety margins equivalent to those contained in OPS 1.515(a)(1) and OPS 1.520, the landing mass of the aeroplane should be the lesser of:
 - a. The landing mass determined in accordance with OPS 1.515(a)(1) or OPS 1.520 as appropriate; or
 - b. The landing mass determined for the automatic landing distance for the appropriate surface condition as given in the AFM, or equivalent document. Increments due to system features such as beam location or elevations, or procedures such as use of overspeed, should also be included.



This Page Intentionally Left Blank



AC/AMC G

PERFORMANCE CLASS A

AMC OPS 1.485(b)

General – Wet and Contaminated Runway Data

See OPS 1.485(b)

If the performance data has been determined on the basis of measured runway friction coefficient, the operator should use a procedure correlating the measured runway friction coefficient and the effective braking coefficient of friction of the aeroplane type over the required speed range for the existing runway conditions.

AMC OPS 1.490(c)(3)

Take-off – Runway Surface Condition

See OPS 1.490(c)(3)

1. Operation on runways contaminated with water, slush, snow or ice implies uncertainties with regard to runway friction and contaminant drag and therefore to the achievable performance and control of the aeroplane during take-off, since the actual conditions may not completely match the assumptions on which the performance information is based. In the case of a contaminated runway, the first option for the commander is to wait until the runway is cleared. If this is impracticable, he may consider a take-off, provided that he has applied the applicable performance adjustments, and any further safety measures he considers justified under the prevailing conditions.
2. An adequate overall level of safety will only be maintained if operations in accordance with CS-25 are limited to rare occasions. Where the frequency of such operations on contaminated runways is not limited to rare occasions, operators should provide additional measures ensuring an equivalent level of safety. Such measures could include special crew training, additional distance factoring and more restrictive wind limitations.

AMC OPS 1.490(c)(6)

Loss of Runway Length Due to Alignment

See OPS 1.490(c)(6)

1. Introduction
 - 1.1 The length of the runway which is declared for the calculation of TODA, ASDA and TORA, does not account for line-up of the aeroplane in the direction of take-off on the runway in use. This alignment distance depends on the aeroplane geometry and access possibility to the runway in use. Accountability is usually required for a 90° taxiway entry to the runway and 180° turnaround on the runway. There are two distances to be considered:
 - a. The minimum distance of the main wheels from the start of the runway for determining TODA and TORA, "L"; and
 - b. The minimum distance of the most forward wheel(s) from the start of the runway for determining ASDA, "N".

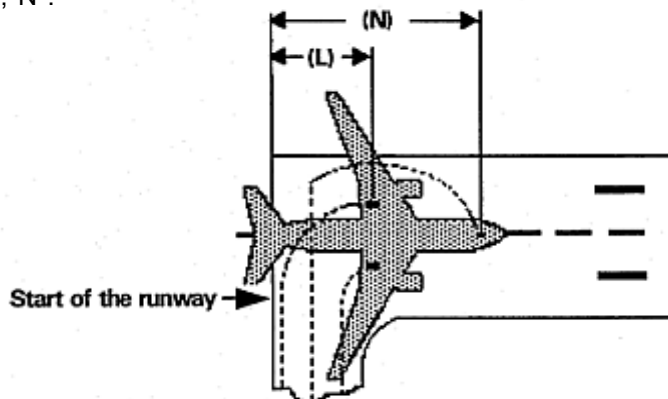

Where the aeroplane manufacturer does not provide the appropriate data, the calculation method given in paragraph 2 may be used to determine the alignment distance.



2. Alignment Distance Calculation

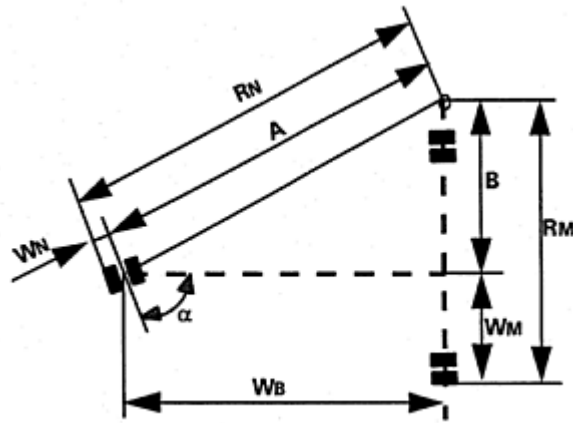

The distances mentioned in (a) and (b) of paragraph 1 above are:

	90° ENTRY	180° TURNAROUND
L=	$R_M + X$	$R_N + Y$
N=	$R_M + X + W_B$	$R_N + Y + W_B$

where: $R_N = A + W_N = \frac{W_B}{\cos(90^\circ - \alpha)} + W_N$

and $R_M = B + W_M = W_B \tan(90^\circ - \alpha) + W_M$

X= Safety distance of outer main wheel during turn to the edge of the runway

Y= Safety distance of outer nose wheel during turn to the edge of the runway

Note: Minimum edge safety distances for X and Y are specified in FAA AC 150/5300-13 and ICAO Annex 14 paragraph 3.8.3

R_N = Radius of turn of outer nose wheel

R_M = Radius of turn of outer main wheel

W_N = Distance from aeroplane centre-line to outer nose wheel

W_M = Distance from aeroplane centre-line to outer main wheel

W_B = Wheel base

α = Steering angle

AMC OPS 1.495(a)
Take-off Obstacle Clearance
See OPS 1.495(a)

1. In accordance with the definitions used in preparing the take-off distance and take-off flight path Data provided in the Aeroplane Flight Manual:
 - a. The net take-off flight path is considered to begin at a height of 35 ft above the runway or clearway at the end of the Take-off distance determined for the aeroplane in accordance with sub-paragraph b. below.
 - b. The take-off distance is the longest of the following distances:



- i. 115% of the distance with all engines operating from the start of the take-off to the point at which the aeroplane is 35 ft above the runway or clearway; or
- ii. The distance from the start of the take-off to the point at which the aeroplane is 35 ft above the runway or clearway assuming failure of the critical engine occurs at the point corresponding to the decision speed (V_1) for a dry runway; or
- iii. If the runway is wet or contaminated, the distance from the start of the take-off to the point at which the aeroplane is 15 ft above the runway or clearway assuming failure of the critical engine occurs at the point corresponding to the decision speed (V_1) for a wet or contaminated runway.

OPS 1.495(a) specifies that the net take-off flight path, determined from the data provided in the Aeroplane Flight Manual in accordance with sub-paragraphs 1(a) and 1(b) above, must clear all relevant obstacles by a vertical distance of 35 ft. When taking off on a wet or contaminated runway and an engine failure occurs at the point corresponding to the decision speed (V_1) for a wet or contaminated runway, this implies that the aeroplane can initially be as much as 20 ft below the net take-off flight path in accordance with sub-paragraph 1 above and, therefore, may clear close-in obstacles by only 15 ft. When taking off on wet or contaminated runways, the operator should exercise special care with respect to obstacle assessment, especially if a take-off is obstacle limited and the obstacle density is high.

AMC OPS 1.495(c)(4)
Take-off Obstacle Clearance
 See OPS 1.495(c)

- 1. The Aeroplane Flight Manual generally provides a climb gradient decrement for a 15° bank turn. For bank angles of less than 15°, a proportionate amount should be applied, unless the manufacturer or Aeroplane Flight Manual has provided other data.
- 2. Unless otherwise specified in the Aeroplane Flight Manual or other performance or operating manuals from the manufacturer, acceptable adjustments to assure adequate stall margins and gradient corrections are provided by the following:

BANK	SPEED	GRADIENT CORRECTION
15°	V_2	1 x Aeroplane Flight Manual 15° Gradient Loss
20°	$V_2 + 5$ kt	2 x Aeroplane Flight Manual 15° Gradient Loss
25°	$V_2 + 10$ kt	3 x Aeroplane Flight Manual 15° Gradient Loss

AMC OPS 1.495(d)(1) & (e)(1)
Required Navigational Accuracy
 See OPS 1.495(d)(1) & (e)(1)

- 1. Flight-deck systems. The obstacle accountability semi-widths of 300 m (see OPS 1.495(d)(1)) and 600 m (see OPS 1.495(e)(1)) may be used if the navigation system under one-engine-inoperative conditions provides a two standard deviation (2σ) accuracy of 150 m and 300 m respectively.
- 2. Visual Course Guidance
- 2.1 The obstacle accountability semi-widths of 300 m (see OPS 1.495(d)(1)) and 600 m (see OPS 1.495(e)(1)) may be used where navigational accuracy is ensured at all relevant points on the flight path by use of external references. These references may be considered visible from the flight deck if they are situated more than 45° either side of the intended track and with a depression of not greater than 20° from the horizontal.
- 2.2 For visual course guidance navigation, the operator should ensure that the weather conditions prevailing at the time of operation, including ceiling and visibility, are such that the obstacle and/or ground reference points can be seen and identified. The Operations Manual should specify, for the aerodrome(s) concerned, the minimum weather conditions which enable the flight crew to continuously determine and maintain the correct flight path with respect to ground reference points, so as to provide a safe clearance with respect to obstructions and terrain as follows:



- a. The procedure should be well defined with respect to ground reference points so that the track to be flown can be analysed for obstacle clearance requirements;
- b. The procedure should be within the capabilities of the aeroplane with respect to forward speed, bank angle and wind effects;
- c. A written and/or pictorial description of the procedure should be provided for crew use;
- d. The limiting environmental conditions (such as wind, the lowest cloud base, ceiling, visibility, day/night, ambient lighting, obstruction lighting) should be specified.

AMC OPS 1.495(f)
Engine Failure Procedures
See OPS 1.495(f)

If compliance with OPS 1.495(f) is based on an engine failure route that differs from the all engine departure route or SID normal departure, a “deviation point” can be identified where the engine failure route deviates from the normal departure route. Adequate obstacle clearance along the normal departure with failure of the critical engine at the deviation point will normally be available. However, in certain situations the obstacle clearance along the normal departure route may be marginal and should be checked to ensure that, in case of an engine failure after the deviation point, a flight can safely proceed along the normal departure.

AMC OPS 1.500
En-Route – One-engine-inoperative
See OPS 1.500

1. The high terrain or obstacle analysis required for showing compliance with OPS 1.500 may be carried out in one of two ways, as explained in the following three paragraphs.
2. A detailed analysis of the route should be made using contour maps of the high terrain and plotting the highest points within the prescribed corridor’s width along the route. The next step is to determine whether it is possible to maintain level flight with one-engine-inoperative 1000 ft above the highest point of the crossing. If this is not possible, or if the associated weight penalties are unacceptable, a driftdown procedure should be worked out, based on engine failure at the most critical point and clearing critical obstacles during the driftdown by at least 2000 ft. The minimum cruise altitude is determined by the intersection of the two driftdown paths, taking into account allowances for decision making (see Figure 1). This method is time consuming and requires the availability of detailed terrain maps.
3. Alternatively, the published minimum flight altitudes (Minimum En route Altitude, MEA, or Minimum Off Route Altitude, MORA) may be used for determining whether one-engine-inoperative level flight is feasible at the minimum flight altitude or if it is necessary to use the published minimum flight altitudes as the basis for the driftdown construction (see Figure 1). This procedure avoids a detailed high terrain contour analysis but may be more penalising than taking the actual terrain profile into account as in paragraph 2.
4. In order to comply with OPS 1.500(c), one means of compliance is the use of MORA and, with OPS 1.500(d), MEA provided that the aeroplane meets the navigational equipment standard assumed in the definition of MEA.



FIGURE 1

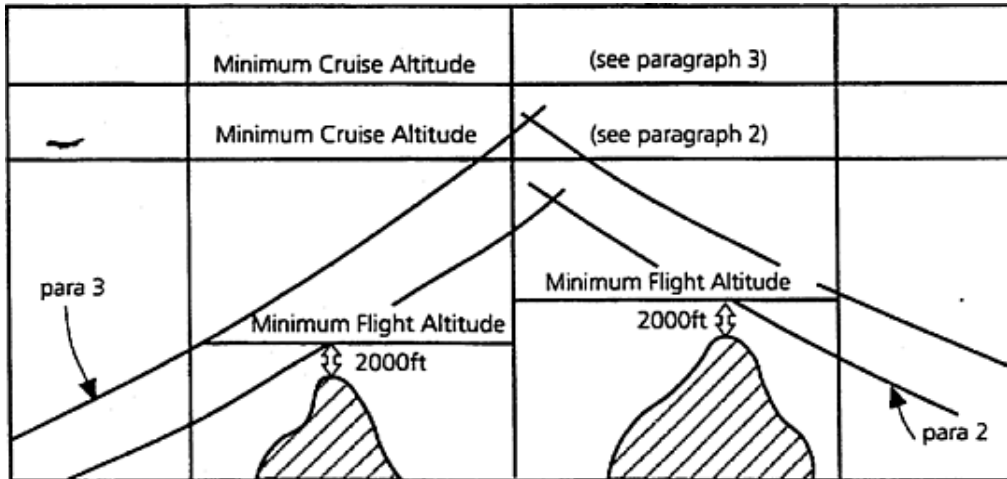

Note: MEA or MORA normally provide the required 2000 ft obstacle clearance for driftdown. However, at and below 6000 ft altitude, MEA and MORA cannot be used directly as only 1000 ft. clearance is ensured.

AMC OPS 1.510(b) and (c)
Landing – Destination and Alternate Aerodromes
 See OPS 1.510(b) and (c)

The required missed approach gradient may not be achieved by all aeroplanes when operating at or near maximum certificated landing mass and in engine-out conditions. Operators of such aeroplanes should consider mass, altitude and temperature limitations and wind for the missed approach. As an alternative method, an increase in the decision altitude/height or minimum descent altitude/height and/or a contingency procedure (see OPS 1.495(f)) providing a safe route and avoiding obstacles, can be approved.

AMC OPS 1.510 & 1.515
Landing – Destination and Alternate Aerodromes - Landing – Dry Runways
 See OPS 1.510 & 1.515

In showing compliance with OPS 1.510 and OPS 1.515, the operator should use either pressure altitude or geometric altitude for his operation and this should be reflected in the Operations Manual.

AMC OPS 1.515(c)
Landing – Dry runway
 See OPS 1.515(c)

1. OPS 1.515(c) establishes two considerations in determining the maximum permissible landing mass at the destination and alternate aerodromes.
2. Firstly, the aeroplane mass will be such that on arrival the aeroplane can be landed within 60% or 70% (as applicable) of the landing distance available on the most favourable (normally the longest) runway in still air. Regardless of the wind conditions, the maximum landing mass for an aerodrome/aeroplane configuration at a particular aerodrome, cannot be exceeded.
3. Secondly, consideration should be given to anticipated conditions and circumstances. The expected wind, or ATC and noise abatement procedures, may indicate the use of a different runway. These factors may result in a lower landing mass than that permitted under paragraph 2 above, in which case, to show compliance with OPS 1.515(a), dispatch should be based on this lesser mass.
4. The expected wind referred to in paragraph 3 is the wind expected to exist at the time of arrival.



This Page Intentionally Left Blank

**AMC H****PERFORMANCE CLASS B****AMC OPS 1.526****S/E Operations at Night or in IMC****1. Purpose and scope**

The purpose of this AMC is to give additional guidance on the airworthiness and operational requirements described in OPS 1.526 and OPS 1.842, which have been designed to meet the overall level of safety intended for approved operations by single-engine turbine-powered aeroplanes at night and/or in IMC.

2. Turbine engine reliability

2.1 The power loss rate required should be established as likely to be met based on data from commercial operations supplemented by available data from private operations in similar theatres of operation. A minimum amount of service experience is needed on which to base the judgment, and this should include at least 20000 hours on the actual aeroplane/engine combination unless additional testing has been carried out or experience on sufficiently similar variants of the engine is available.

2.2 In assessing turbine engine reliability, evidence should be derived from a world fleet database covering as large a sample as possible of operations considered to be representative, compiled by the manufacturers and reviewed with the States of Design and of the Operator. Since flight hour reporting is not mandatory for many types of operators, appropriate statistical estimates may be used to develop the engine reliability data. Data for individual operators approved for these operations including trend monitoring and event reports should also be monitored and reviewed by the State of the Operator to ensure that there is no indication that the operator's experience is unsatisfactory.

2.2.1 Engine trend monitoring should include the following:

- a. an oil consumption monitoring programme based on manufacturers' recommendations; and
- b. an engine condition monitoring programme describing the parameters to be monitored, the method of data collection and the corrective action process; this should be based on the manufacturer's recommendations. The monitoring is intended to detect turbine engine deterioration at an early stage to allow for corrective action before safe operation is affected.

2.2.2 A reliability programme should be established covering the engine and associated systems. The engine programme should include engine hours flown in the period and the in-flight shutdown rate for all causes and the unscheduled engine removal rate, both on a 12-month moving average basis. The event reporting process should cover all items relevant to the ability to operate safely at night and/or in IMC. The data should be available for use by the operator, the Type Certificate Holder and the Authority so as to establish that the intended reliability levels are being achieved. Any sustained adverse trend should result in an immediate evaluation by the operator in consultation with the Authority and manufacturer with a view to determining actions to restore the intended safety level. The operator should develop a parts control programme with support from the manufacturer that ensures that the proper parts and configuration are maintained for single-engine turbine-powered aeroplanes approved to conduct these operations.

The programme includes verification that parts placed on an approved single-engine turbine-powered aeroplane during parts borrowing or pooling arrangements, as well as those parts used after repair or overhaul, maintain the necessary configuration of that aeroplane for operations approved in accordance with OPS 1.526.

2.3 Power loss rate should be determined as a moving average over a specified period (e.g. a 12-month moving average if the sample is large). Power loss rate, rather than in-flight shut-down rate, has been used as it is considered to be more appropriate for a single-engine aeroplane. If a failure occurs on a multi-engine aeroplane that causes a major, but not total, loss of power on one engine, it is likely that the engine will be shut down as positive engine-out performance is still available, whereas on a single-engine aeroplane it may well be decided to make use of the residual power to stretch the glide distance.



- 2.4 The actual period selected should reflect the global utilization and the relevance of the experience included (e.g. early data may not be relevant due to subsequent mandatory modifications which affected the power loss rate). After the introduction of a new engine variant and whilst global utilization is relatively low, the total available experience may have to be used to try to achieve a statistically meaningful average.

3. Operations Manual

The Operations Manual should include all necessary information relevant to operations by single-engine turbine-powered aeroplanes at night and/or in IMC. This should include all of the additional equipment, procedures and training required for such operations, route and/or area of operation and aerodrome information (including and operating minima).

4. Operator certification or validation

The certification or validation process specified by the Authority will ensure the adequacy of the operator's procedures for normal, abnormal and emergency operations, including actions following engine, systems or equipment failures. In addition to the normal requirements for operator certification or validation, the following items should be addressed in relation to operations by single-engine turbine-powered aeroplanes:

- a. proof of the achieved engine reliability of the aeroplane engine combination;
- b. specific and appropriate training and checking procedures including those to cover engine failure/malfunction on the ground, after take-off and en-route and descend to a forced landing from the normal cruising altitude;
- c. a maintenance programme which is extended to address the equipment and systems;
- d. an MEL modified to address the equipment and systems necessary for operations at night and/or in IMC;
- e. planning and operating minima appropriate to the operations at night and/or in IMC;
- f. departure and arrival procedures and any route limitations;
- g. pilot qualifications and experience; and
- h. the Operations Manual, including limitations, emergency procedures, approved routes or areas of operation, the MEL and normal procedures related to the equipment.

5. Operational and maintenance programme requirements

- 5.1 Approval to undertake operations by single-engine turbine-powered aeroplanes at night and/or in IMC specified in an air operator certificate or equivalent document should include the particular airframe/engine combinations, including the current type design standard for such operations, the specific aeroplanes approved, and the areas or routes of such operations.
- 5.2 The operator's maintenance management exposition should include a statement of certification of the additional equipment required, and of the maintenance and reliability programme for such equipment, including the engine.

6. Route limitations over water

- 6.1 Operators of single-engine turbine-powered aeroplanes carrying out operations at night and/or in IMC should make an assessment of route limitations over water. The distance that the aeroplane may be operated from a land mass suitable for a safe forced landing should be determined. This equates to the glide distance from the cruise altitude to the safe forced landing area following engine failure, assuming still air conditions. States may add to this an additional distance taking into account the likely prevailing conditions and type of operation. This should take into account the likely sea conditions, the survival equipment carried, the achieved engine reliability and the search and rescue services available.
- 6.2 Any additional distance allowed beyond the glide distance should not exceed a distance equivalent to 15 minutes at the aeroplane's normal cruise speed.



AMC OPS 1.526(i)
S/E operations - Forced Landing Areas

Operation over routes and in weather conditions that permit a safe forced landing in the event of an engine failure, is not required for aeroplanes approved in accordance with OPS 1.526. The availability of forced landing areas at all points along a route is not specified for these aeroplanes because of the very high engine reliability, additional systems and operational equipment, procedures and training requirements.

AMC OPS 1.530(c)(4)
Take-off Performance Correction Factors
See OPS 1.530(c)(4)

Unless otherwise specified in the Aeroplane Flight Manual or other performance or operating manuals from the manufacturers, the variables affecting the take-off performance and the associated factors that should be applied to the Aeroplane Flight Manual data are shown in the table below. They should be applied in addition to the operational factors as prescribed in OPS 1.530(b).

SURFACE TYPE	CONDITION	FACTOR
	Dry	1.20
	Wet	1.30
Paved	Wet	1.00

- Notes:
1. *The soil is firm when there are wheel impressions but no rutting.*
 2. *When taking off on grass with a Single-engine aeroplane, care should be taken to assess the rate of acceleration and consequent distance increase.*
 3. *When making a rejected take-off on very short grass which is wet, and with a firm subsoil, the surface may be slippery, in which case the distances may increase significantly.*

AMC OPS 1.530(c)(4)
Take-off Performance Correction Factors
See OPS 1.530(c)(4)

Due to the inherent risks, operations from contaminated runways are inadvisable, and should be avoided whenever possible. Therefore, it is advisable to delay the take-off until the runway is cleared. Where this is impracticable, the commander should also consider the excess runway length available including the criticality of the overrun area.

AMC OPS 1.530(c)(5)
Runway Slope
See OPS 1.530(c)(5)

Unless otherwise specified in the Aeroplane Flight Manual, or other performance or operating manuals from the manufacturers, the take-off distance should be increased by 5% for each 1% of upslope except that correction factors for runways with slopes in excess of 2% require the acceptance of the Authority.

AMC OPS 1.535
Obstacle Clearance in Limited Visibility
See OPS 1.535

- 1 The intent of the complementary requirements OPS 1.535 and Appendix 1 to OPS 1.430 sub-paragraph (a)(3)(ii) is to enhance safe operation with Performance Class B aeroplanes in conditions of limited visibility. Unlike the Performance Class A airworthiness requirements, those for Performance Class B do not necessarily provide for engine failure in all phases of flight. It is accepted that performance accountability for engine failure need not be considered until a height of 300 ft is reached.
- 2 The weather minima given in Appendix 1 to OPS 1.430 sub-paragraph (a)(3)(ii) up to and including 300 ft imply that if a take-off is undertaken with minima below 300 ft a one-engine-inoperative flight path must be plotted starting on the all-engine take-off flight path at the assumed engine failure height. This path must meet the vertical and lateral obstacle clearance specified in OPS 1.535. Should engine failure occur below



this height, the associated visibility is taken as being the minimum which would enable the pilot to make, if necessary, a forced landing broadly in the direction of the take-off. At or below 300 ft, a circle and land procedure is extremely inadvisable. Appendix 1 to OPS 1.430 sub-paragraph (a)(3)(ii) specifies that, if the assumed engine failure height is more than 300 ft, the visibility must be at least 1500 m and, to allow for manoeuvring, the same minimum visibility should apply whenever the obstacle clearance criteria for a continued take-off cannot be met.

AMC OPS 1.535(a)
Take-off Flight Path Construction
See OPS 1.535(a)

1. Introduction. For demonstrating that an aeroplane clears all obstacles vertically, a flight path should be constructed consisting of an all-engine segment to the assumed engine failure height, followed by an engine-out segment. Where the Aeroplane Flight Manual does not contain the appropriate data, the approximation given in paragraph 2 below may be used for the all-engine segment for an assumed engine failure height of 200 ft, 300 ft, or higher.
2. Flight Path Construction
 - 2.1 All-Engines Segment (50 ft to 300 ft). The average all-engines gradient for the all-engines flight path segment starting at an altitude of 50 ft at the end of the take-off distance ending at or passing through the 300 ft point is given by the following formula:

$$Y_{300} = \frac{0.57(Y_{ERC})}{1 + (V_{ERC}^2 - V_2^2) / 5647}$$

Note: The factor of 0.77 as required by OPS 1.535(a)(4) is already included where:

- Y_{300} = Average all-engines gradient from 50 ft to 300 ft
- Y_{ERC} = Scheduled all engines en-route gross climb gradient
- V_{ERC} = En-route climb speed, all engines knots TAS
- V_2 = Take-off speed at 50 ft, knots TAS

(See AMC OPS 1.535(a), Figure 1a for graphical presentation)

- 2.2 All-Engines Segment (50 ft to 200 ft). (May be used as an alternative to 2.1 where weather minima permits) The average all-engine gradient for the all-engine flight path segment starting at an altitude of 50 ft at the end of the take-off distance ending at or passing through the 200 ft point is given by the following formula:

$$Y_{200} = \frac{0.51(Y_{ERC})}{1 + (V_{ERC}^2 - V_2^2) / 3388}$$

Note: The factor of 0.77 as required by OPS 1.535(a)(4) is already included where:

- Y_{200} = Average all-engines gradient from 50 ft to 200 ft
- Y_{ERC} = Scheduled all engines en-route gross climb gradient
- V_{ERC} = En-route climb speed, all engines, knots TAS
- V_2 = Take-off speed at 50 ft, knots TAS

(See AMC OPS 1.535(a), Figure 1b for graphical presentation)

- 2.3 All-Engines Segment (above 300 ft). The all-engines flight path segment continuing from an altitude of 300 ft is given by the AFM en-route gross climb gradient, multiplied by a factor of 0.77.
- 2.4 The One-engine-inoperative Flight Path. The one-engine-inoperative flight path is given by the one-engine-inoperative gradient chart contained in the AFM.



3. Worked examples of the method given above are contained in AMC OPS 1.535(a).

AMC OPS 1.535(a)
Take-off Flight Path Construction
See OPS 1.535(a)

1. This AMC provides examples to illustrate the method of take-off flight path construction given in AMC OPS 1.535(a). The examples shown below are based on an aeroplane for which the Aeroplane Flight Manual shows, at a given mass, altitude, temperature and wind component the following performance data:

Factored take-off distance	–	1000 m
Take-off speed, V ₂	–	90 kt
En-route climb speed, V _{ERC}	–	120 kt
En-route all-engine climb gradient, Y _{ERC}	–	0.200
En-route one-engine-inoperative climb gradient, Y _{ERC-1}	–	0.032

a. Assumed engine failure height 300 ft. The average all-engine gradient from 50 ft to 300 ft may be read from Figure 1a (page 2–H–8) or calculated with the following formula:

$$Y_{300} = \frac{0.57(Y_{ERC})}{1 + (V_{ERC}^2 - V_2^2) / 5647}$$

NOTE: The factor of 0.77 as required by OPS 1.535(a)(4) is already included where:

- Y₃₀₀ = Average all-engines gradient from 50 ft to 300 ft
- Y_{ERC} = Scheduled all engines en-route gross climb gradient
- V_{ERC} = En-route climb speed, all engines knots TAS
- V₂ = Take-off speed at 50 ft, knots TAS

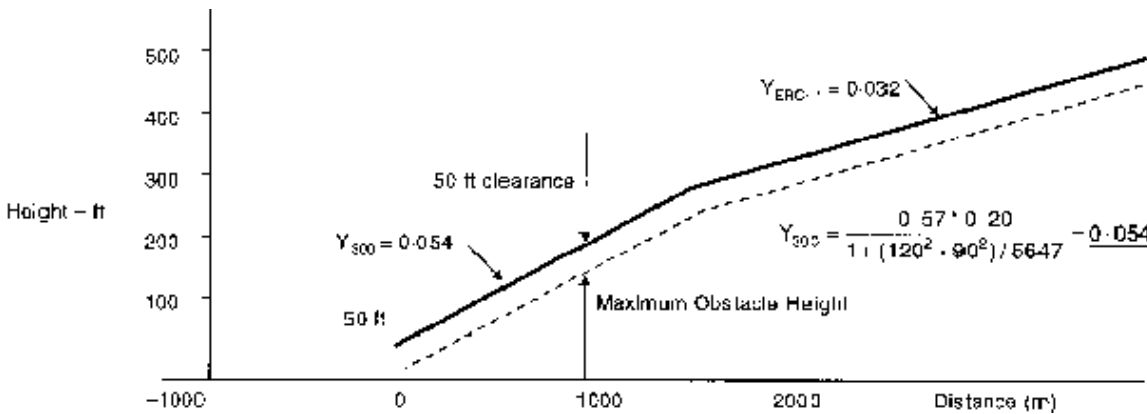

b. Assumed engine failure height 200 ft. The average all-engine gradient from 50 ft to 200 ft may be read from Figure 1b (page 2–H–9) or calculated with the

following formula:

$$Y_{200} = \frac{0.51(Y_{ERC})}{1 + (V_{ERC}^2 - V_2^2) / 3388}$$

Note: The factor of 0.77 as required by OPS 1.535(a)(4) is already included where:

- Y₂₀₀ = Average all-engines gradient from 50 ft to 200 ft
- Y_{ERC} = Scheduled all engines en-route gross gradient
- V_{ERC} = En-route climb speed, all engines, knots TAS
- V₂ = Take-off speed at 50 ft, knots TAS

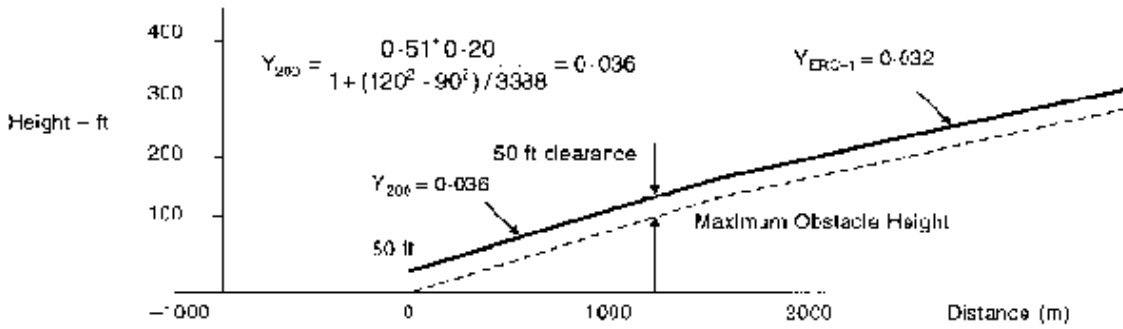

c. Assumed engine failure height less than 200 ft. Construction of a take-off flight path is only possible if the AFM contains

the required flight path data.

d. Assumed engine failure height more than 300 ft. The construction of a take-off flight path for an assumed engine failure height of 400 ft is illustrated below.

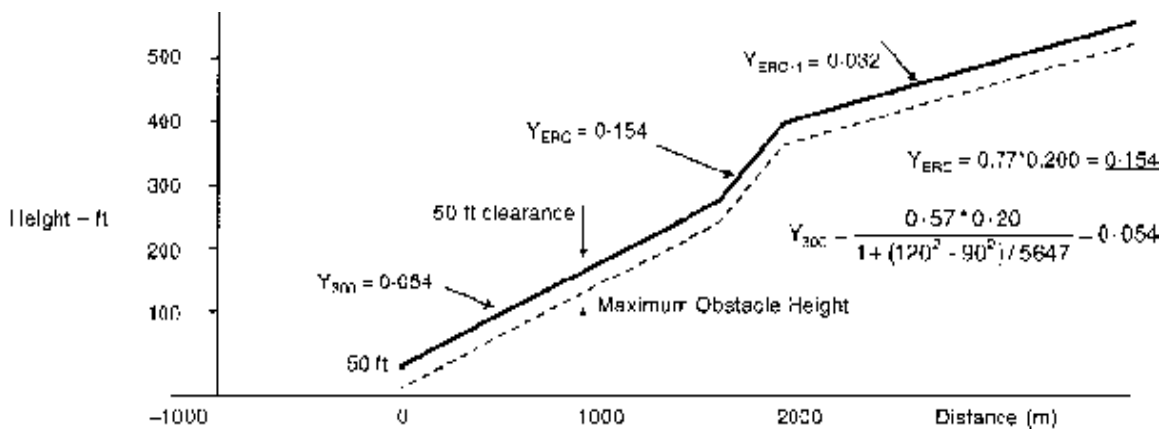

AMC OPS 1.540
En-Route
See OPS 1.540

1. The altitude at which the rate of climb equals 300 ft per minute is not a restriction on the maximum cruising altitude at which the aeroplane can fly in practice, it is merely the maximum altitude from which the driftdown procedure can be planned to start.
2. Aeroplanes may be planned to clear en-route obstacles assuming a driftdown procedure, having first increased the scheduled en-route one-engine-inoperative descent data by 0.5% gradient.

AMC OPS 1.542
En-route – Single-engine Aeroplanes
See OPS 1.542

1. In the event of an engine failure, single-engine aeroplanes have to rely on gliding to a point suitable for a safe forced landing. Such a procedure is clearly incompatible with flight above a cloud layer which extends below the relevant minimum safe altitude.
2. Operators should first increase the scheduled engine-inoperative gliding performance data by 0.5% gradient when verifying the en-route clearance of obstacles and the ability to reach a suitable place for a forced landing.
3. The altitude at which the rate of climb equals 300 ft per minute is not a restriction on the maximum cruising altitude at which the aeroplane can fly in practice, it is merely the maximum altitude from which the engine-inoperative procedure can be planned to start.



AMC OPS 1.542(a)
En-Route - Single-engine Aeroplanes
See OPS 1.542(a)

OPS 1.542(a) requires the operator to ensure that in the event of an engine failure, the aeroplane should be capable of reaching a point from which a successful forced landing can be made. Unless otherwise specified by the Authority, this point should be 1000ft above the intended landing area.

AMC OPS 1.545 & 1.550
Landing Destination and Alternate Aerodromes
Landing - Dry runway
See OPS 1.545 & 1.550

In showing compliance with OPS 1.545 & OPS 1.550, the operator should use either pressure altitude or geometric altitude for his operation and this should be reflected in the Operations Manual.

AMC OPS 1.550(b)(3)
Landing Distance Correction Factors
See OPS 1.550(b)(3)

Unless otherwise specified in the Aeroplane Flight Manual, or other performance or operating manuals from the manufacturers, the variable affecting the landing performance and the associated factor that should be applied to the Aeroplane Flight Manual data is shown in the table below. It should be applied in addition to the operational factors as prescribed in OPS 1.550(a).

SURFACE TYPE	FACTOR
Grass (on firm soil up to 20 cm long)	1.15

Note: The soil is firm when there are wheel impressions but no rutting

AMC OPS 1.550(b)(4)
Runway Slope
See OPS 1.550(b)(4)

Unless otherwise specified in the Aeroplane Flight Manual, or other performance or operating manuals from the manufacturer, the landing distances required should be increased by 5% for each 1% of downslope except that correction factors for runways with slopes in excess of 2% need the acceptance of the Authority.

AMC OPS 1.550(c)
Landing – Dry Runway
See OPS 1.550(c)

- OPS 1.550(c) establishes two considerations in determining the maximum permissible landing mass at the destination and alternate aerodromes.
- Firstly, the aeroplane mass will be such that on arrival the aeroplane can be landed within 70% of the landing distance available on the most favourable (normally the longest) runway in still air. Regardless of the wind conditions, the maximum landing mass for an aerodrome/aeroplane configuration at a particular aerodrome, cannot be exceeded.
- Secondly, consideration should be given to anticipated conditions and circumstances. The expected wind, or ATC and noise abatement procedures, may indicate the use of a different runway. These factors may result in a lower landing mass than that permitted under paragraph 2 above, in which case, to show compliance with OPS 1.550(a), dispatch should be based on this lesser mass.
- The expected wind referred to in paragraph 3 is the wind expected to exist at the time of arrival.



AMC OPS 1.555(a)
Landing on Wet Grass Runways
See OPS 1.555(a)

1. When landing on very short grass which is wet, and with a firm subsoil, the surface may be slippery, in which case the distances may increase by as much as 60% (1.60 factor).
2. As it may not be possible for a pilot to determine accurately the degree of wetness of the grass, particularly when airborne, in cases of doubt, the use of the wet factor (1.15) is recommended.

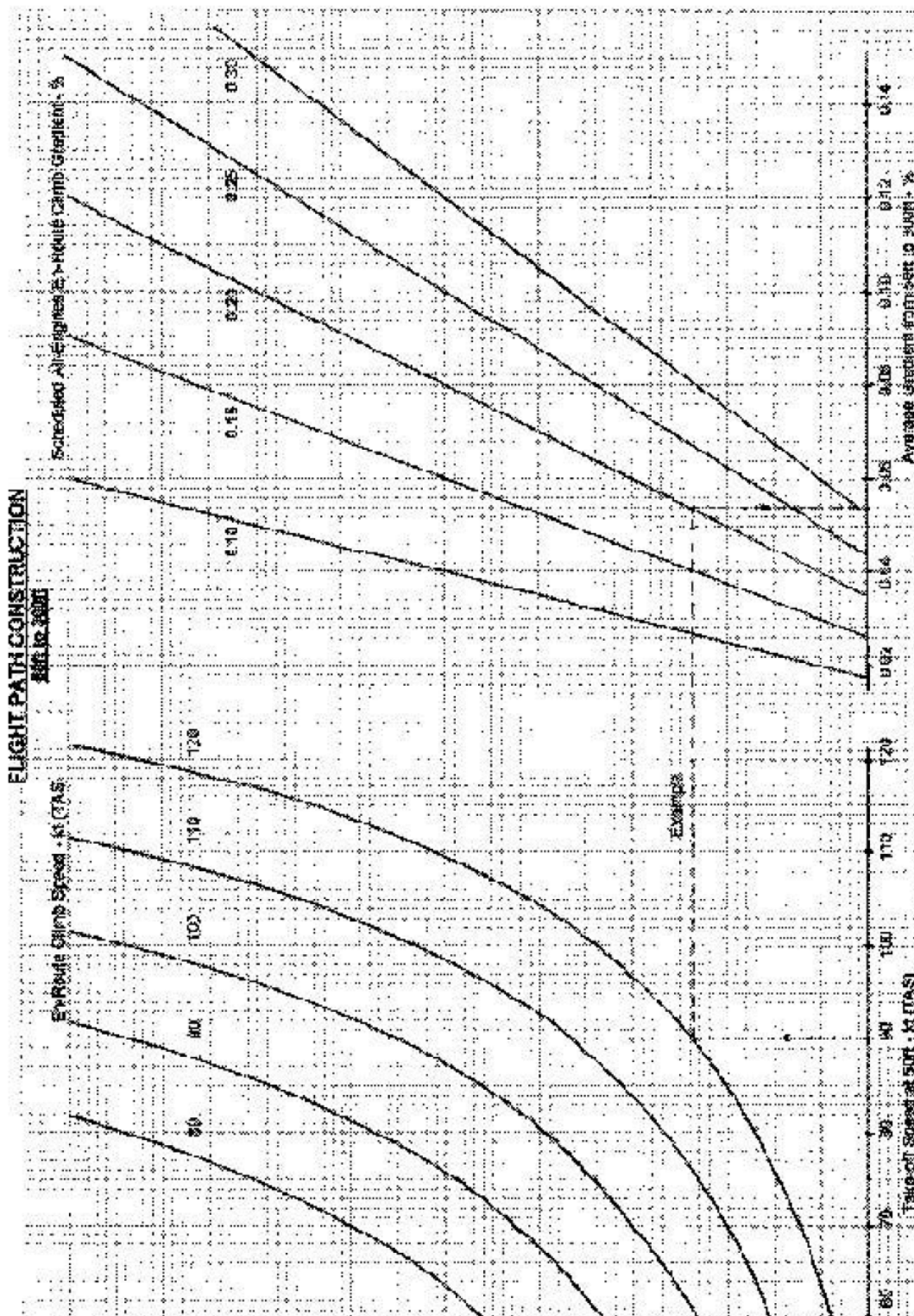

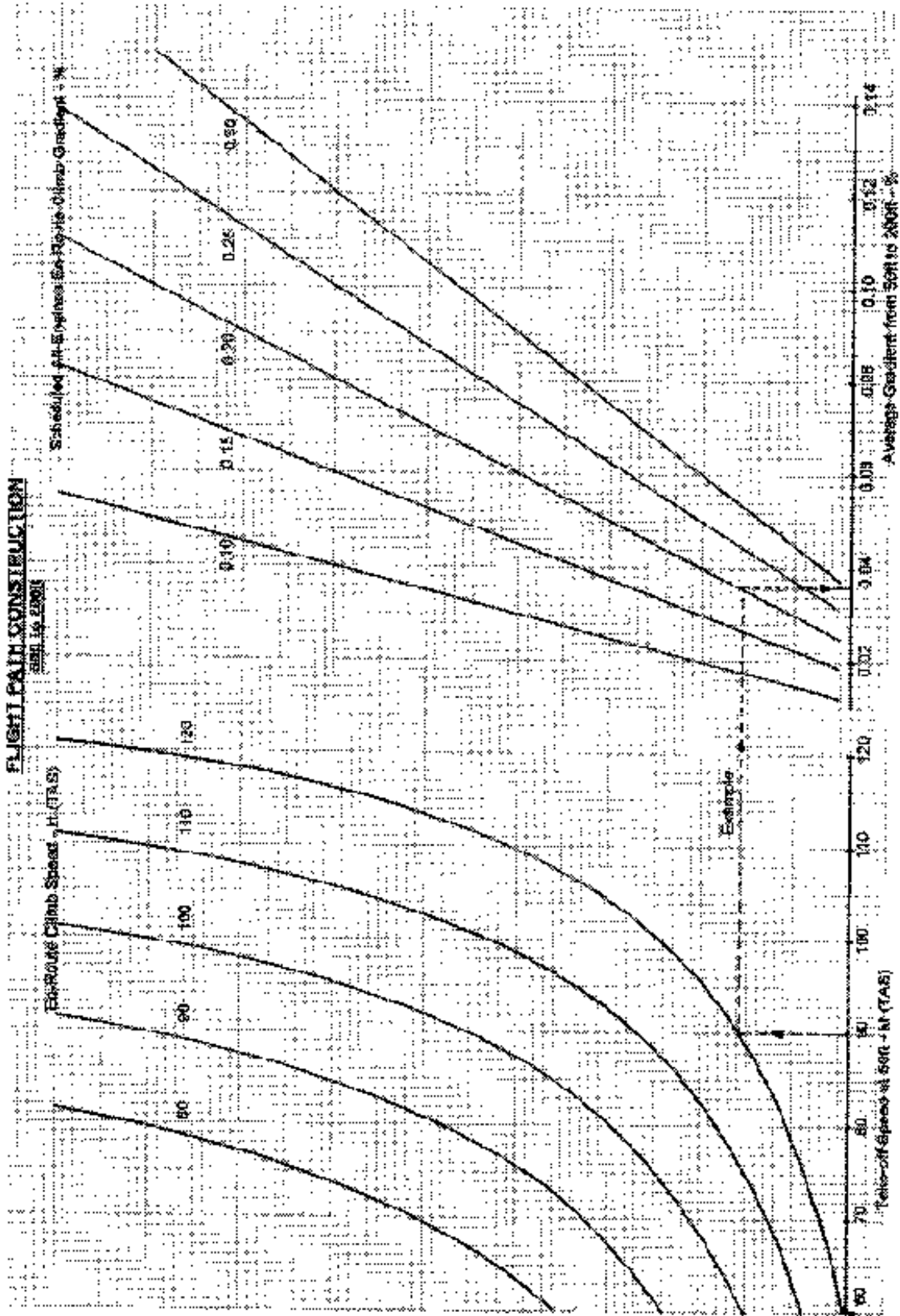

This

Page



This Page Intentionally Left Blank



AMC I

PERFORMANCE CLASS C

AMC OPS 1.565(d)(3)

Take-off

See OPS 1.565(d)(3)

Operation on runways contaminated with water, slush, snow or ice implies uncertainties with regard to runway friction and contaminant drag and therefore to the achievable performance and control of the aeroplane during Take-off, since the actual conditions may not completely match the assumptions on which the performance information is based. An adequate overall level of safety can, therefore, only be maintained if such operations are limited to rare occasions. In case of a contaminated runway the first option for the commander is to wait until the runway is cleared. If this is impracticable, he may consider a take-off, provided that he has applied the applicable performance adjustments, and any further safety measures he considers justified under the prevailing conditions.

AMC OPS 1.565(d)(6)

Loss of Runway Length Due to Alignment

See OPS 1.565(d)(6)

1. Introduction

1.1 The length of the runway which is declared for the calculation of TODA, ASDA and TORA, does not account for line-up of the aeroplane in the direction of take-off on the runway in use. This alignment distance depends on the aeroplane geometry and access possibility to the runway in use. Accountability is usually required for a 90° taxiway entry to the runway and 180° turnaround on the runway. There are two distances to be considered:

- a. The minimum distance of the main wheels from the start of the runway for determining TODA and TORA, "L"; and
- b. The minimum distance of the most forward wheel(s) from the start of the runway for determining ASDA, "N".

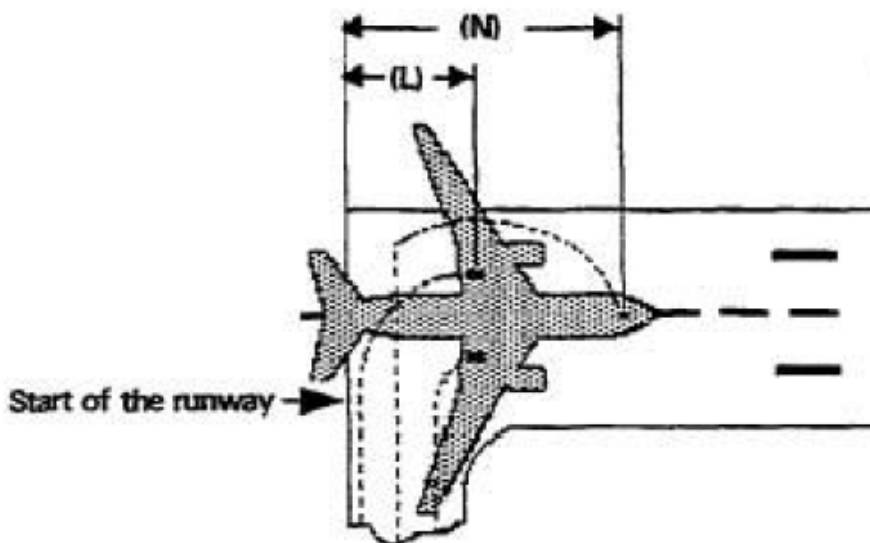

Where the aeroplane manufacturer does not provide the appropriate data, the calculation method given in paragraph 2 may be used to determine the alignment distance.



2. Alignment Distance Calculation

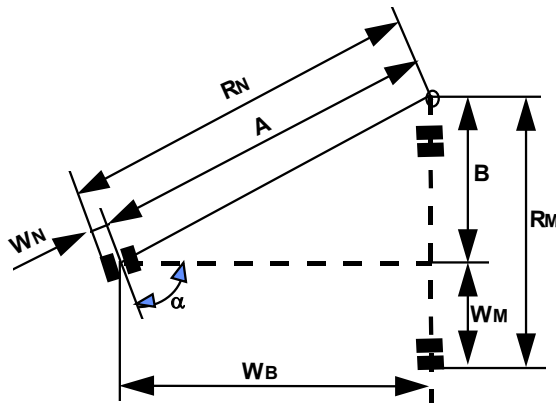

The distances mentioned in (a) and (b) of paragraph 1 above are:

	90° ENTRY	180° TURNAROUND
L =	$R_M + X$	$R_N + Y$
N =	$R_M + X + W_B$	$R_N + Y + W_B$

where:

$$R_N = A + W_N = \frac{W_B}{\cos(90^\circ - \alpha)}$$

and

$$R_M = B + W_M = W_B \tan(90^\circ - \alpha)$$

X = Safety distance of outer main wheel during turn to the edge of the runway

Y = Safety distance of outer nose wheel during turn to the edge of the runway

Note: Minimum edge safety distances for X and Y are specified in FAA AC 150/5300-13 and ICAO Annex 14 paragraph 3.8.3

R_N = Radius of turn of outer nose wheel

R_M = Radius of turn of outer main wheel

W_N = Distance from aeroplane centre-line to outer nose wheel

W_M = Distance from aeroplane centre-line to outer main wheel

W_B = Wheel base

a = Steering angle

AMC OPS 1.565(d)(4)
Runway Slope
 See OPS 1.565(d)(4)

Unless otherwise specified in the Aeroplane Flight Manual, or other performance or operating manuals from the manufacturers, the take-off distance should be increased by 5% for each 1% of upslope except that correction factors for runways with slopes in excess of 2% need the acceptance of the Authority.



**AMC OPS 1.570(d)
Take-off Flight Path
See OPS 1.570(d)**

1. The Aeroplane Flight Manual generally provides a climb gradient decrement for a 15° bank turn. Unless otherwise specified in the Aeroplane Flight Manual or other performance or operating manuals from the manufacturer, acceptable adjustments to assure adequate stall margins and gradient corrections are provided by the following:

BANK	SPEED	GRADIENT CORRECTION
15°	V ₂	1 x Aeroplane Flight Manual 15° Gradient Loss
20°	V ₂ + 5 kt	2 x Aeroplane Flight Manual 15° Gradient Loss
25°	V ₂ + 10 kt	3 x Aeroplane Flight Manual 15° Gradient Loss

2. For bank angles of less than 15°, a proportionate amount may be applied, unless the manufacturer or Aeroplane Flight Manual has provided other data.

**AMC OPS 1.570(e)(1) & (f)(1)
Required Navigational Accuracy
See OPS 1.570(e)(1) & (f)(1)**

1. Flight-deck systems. The obstacle accountability semi-widths of 300 m (see OPS 1.570(e)(1)) and 600 m (see OPS 1.570(f)(1)) may be used if the navigation system under one-engine-inoperative conditions provides a two standard deviation (2 σ) accuracy of 150 m and 300 m respectively.
2. Visual Course Guidance
 - 2.1 The obstacle accountability semi-widths of 300 m (see OPS 1.570(e)(1)) and 600 m (see OPS 1.570(f)(1)) may be used where navigational accuracy is ensured at all relevant points on the flight path by use of external references. These references may be considered visible from the flight deck if they are situated more than 45° either side of the intended track and with a depression of not greater than 20° from the horizontal.
 - 2.2 For visual course guidance navigation, the operator should ensure that the weather conditions prevailing at the time of operation, including ceiling and visibility, are such that the obstacle and/or ground reference points can be seen and identified. The Operations Manual should specify, for the aerodrome(s) concerned, the minimum weather conditions which enable the flight crew to continuously determine and maintain the correct flight path with respect to ground reference points, so as to provide a safe clearance with respect to obstructions and terrain as follows:
 - a. The procedure should be well defined with respect to ground reference points so that the track to be flown can be analysed for obstacle clearance requirements;
 - b. The procedure should be within the capabilities of the aeroplane with respect to forward speed, bank angle and wind effects;
 - c. A written and/or pictorial description of the procedure should be provided for crew use;
 - d. The limiting environmental conditions (such as wind, the lowest cloud base, ceiling, visibility, day/night, ambient lighting, obstruction lighting) should be specified.



AMC OPS 1.580
En-Route – One-engine-inoperative
See OPS 1.580

The high terrain or obstacle analysis required for showing compliance with OPS 1.580 can be carried out by making a detailed analysis of the route using contour maps of the high terrain, and plotting the highest points within the prescribed corridor width along the route. The next step is to determine whether it is possible to maintain level flight with one-engine-inoperative 1000 ft above the highest point of the crossing. If this is not possible, or if the associated weight penalties are unacceptable, a drift-down procedure must be evaluated, based on engine failure at the most critical point, and must show obstacle clearance during the drift-down by at least 2000 ft. The minimum cruise altitude is determined from the drift-down path, taking into account allowances for decision making, and the reduction in the scheduled rate of climb (See Figure 1).

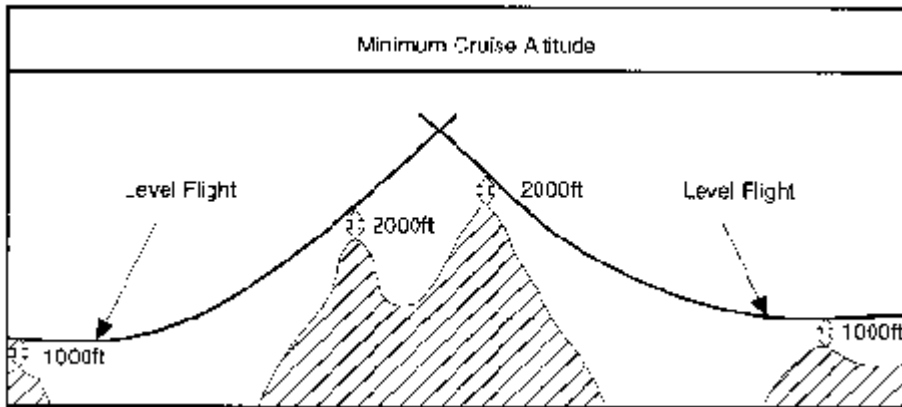

FIGURE 1

AMC OPS 1.590 & 1.595
Landing – Destination and Alternate Aerodromes
Landing – Dry Runways
See OPS 1.590 & 1.595

In showing compliance with OPS 1.590 and OPS 1.595, the operator should use either pressure altitude or geometric altitude for his operation and this should be reflected in the Operations Manual.

AMC OPS 1.595(b)(3)
Landing Distance Correction Factors
See OPS 1.595(b)(3)

Unless otherwise specified in the Aeroplane Flight Manual or other performance or operating manuals from the manufacturers, the variables affecting the landing performance and the associated factors to be applied to the Aeroplane Flight Manual data are shown in the table below. It should be applied in addition to the factor specified in OPS 1.595(a).

SURFACE TYPE	FACTOR
Grass (on firm soil up to 13 cm long)	1.20

Note: The soil is firm when there are wheel impressions but no rutting.



AMC OPS 1.595(b)(4)
Runway Slope
See OPS 1.595(b)(4)

Unless otherwise specified in the Aeroplane Flight Manual, or other performance or operating manuals from the manufacturer, the landing distances required should be increased by 5% for each 1% of downslope.

AMC OPS 1.595(c)
Landing Runway
See OPS 1.595(c)

1. OPS 1.595(c) establishes two considerations in determining the maximum permissible landing mass at the destination and alternate aerodromes.
2. Firstly, the aeroplane mass will be such that on arrival the aeroplane can be landed within 70% of the landing distance available on the most favourable (normally the longest) runway in still air. Regardless of the wind conditions, the maximum landing mass for an aerodrome/aeroplane configuration at a particular aerodrome, cannot be exceeded.
3. Secondly, consideration should be given to anticipated conditions and circumstances. The expected wind, or ATC and noise abatement procedures, may indicate the use of a different runway. These factors may result in a lower landing mass than that permitted under paragraph 2 above, in which case, to show compliance with OPS 1.595(a), dispatch should be based on this lesser mass.
4. The expected wind referred to in paragraph 3 is the wind expected to exist at the time of arrival.



This Page Intentionally Left Blank



AC/AMC J

MASS & BALANCE

AMC OPS 1.605(e)**Fuel Density****See OPS 1.605(e)**

- 1 If the actual fuel density is not known, the operator may use the standard fuel density values specified in the Operations Manual for determining the mass of the fuel load. Such standard values should be based on current fuel density measurements for the airports or areas concerned. Typical fuel density values are:
- | | | | |
|----|-------------------------------|---|------|
| a. | Gasoline (piston engine fuel) | – | 0.71 |
| b. | Jet fuel JP 1 | – | 0.79 |
| c. | Jet fuel JP 4 | – | 0.76 |
| d. | Oil | – | 0.88 |

AC OPS 1.605**Mass Values****See OPS 1.605**

In accordance with ICAO Annex 5 and the International System of Units (SI), the actual and limiting masses of aeroplanes, the payload and its constituent elements, the fuel load etc., are expressed in OPS 1 in units of mass (kg). However, in most approved Flight Manuals and other operational documentation, these quantities are published as weights in accordance with the common language. In the SI system, a weight is a force rather than a mass. Since the use of the term 'weight' does not cause any problem in the day-to-day handling of aeroplanes, its continued use in operational applications and publications is acceptable.

AMC to Appendix 1 to OPS 1.605**Accuracy of Weighing Equipment****See Appendix 1 to OPS 1.605, paragraph (a)(4)(iii)**

1. The mass of the aeroplane as used in establishing the dry operating mass and the centre of gravity must be established accurately. Since a certain model of weighing equipment is used for initial and periodic weighing of aeroplanes of widely different mass classes, one single accuracy criterion for weighing equipment cannot be given. However, the weighing accuracy is considered satisfactory if the following accuracy criteria are met by the individual scales/cells of the weighing equipment used:
- | | | | |
|----|--|---|---------------------------------|
| a. | For a scale/cell load below 2000 kg | – | an accuracy of $\pm 1\%$; |
| b. | For a scale/cell load from 2000 kg to 20000 kg | – | an accuracy of ± 20 kg; and |
| c. | For a scale/cell load above 20000 kg | – | an accuracy of $\pm 0.1\%$. |

AMC to Appendix 1 to OPS 1.605**Centre of Gravity Limits****See Appendix 1 to OPS 1.605, sub-paragraph (d)**

1. In the Certificate Limitations section of the Aeroplane Flight Manual, forward and aft centre of gravity (CG) limits are specified. These limits ensure that the certification stability and control criteria are met throughout the whole flight and allow the proper trim setting for take-off. The operator should ensure that these limits are observed by defining operational procedures or a CG envelope which compensates for deviations and errors as listed below:
- 1.1 Deviations of actual CG at empty or operating mass from published values due, for example, to weighing errors, unaccounted modifications and/or equipment variations.
 - 1.2 Deviations in fuel distribution in tanks from the applicable schedule.
 - 1.3 Deviations in the distribution of baggage and cargo in the various compartments as compared with the assumed load distribution as well as inaccuracies in the actual mass of baggage and cargo.



- 1.4 Deviations in actual passenger seating from the seating distribution assumed when preparing the mass and balance documentation. (See Note)
- 1.5 Deviations of the actual CG of cargo and passenger load within individual cargo compartments or cabin sections from the normally assumed mid position.
- 1.6 Deviations of the CG caused by gear and flap positions and by application of the prescribed fuel usage procedure (unless already covered by the certified limits).
- 1.7 Deviations caused by in-flight movement of cabin crew, pantry equipment and passengers.

Note: Large CG errors may occur when 'free seating' (freedom of passengers to select any seat when entering the aeroplane) is permitted. Although in most cases reasonably even longitudinal passenger seating can be expected, there is a risk of an extreme forward or aft seat selection causing very large and unacceptable CG errors (assuming that the balance calculation is done on the basis of an assumed even distribution). The largest errors may occur at a load factor of approximately 50% if all passengers are seated in either the forward or aft half of the cabin. Statistical analysis indicates that the risk of such extreme seating adversely affecting the CG is greatest on small aeroplanes.

AMC OPS 1.620(a)

Passenger Mass Established by Use of a Verbal Statement

See OPS 1.620(a)

1. When asking each passenger on aeroplanes with less than 10 passenger seats for his/her mass (weight), specific constants should be added to account for hand baggage and clothing. These constants should be determined by the operator on the basis of studies relevant to his particular routes, etc. and should not be less than:
 - a. For clothing - 4 kg; and
 - b. For hand baggage - 6 kg.
2. Personnel boarding passengers on this basis should assess the passenger's stated mass and the mass of passengers' clothing and hand baggage to check that they are reasonable. Such personnel should have received instruction on assessing these mass values. Where necessary, the stated mass and the specific constants should be increased so as to avoid gross inaccuracies.

AMC OPS 1.620(d)(2)

Holiday Charter

See OPS 1.620(d)(2)

A "charter flight solely intended as an element of a holiday travel package" is a flight where the entire passenger capacity is hired by one or more Charterer(s) for the carriage of passengers who are travelling, all or in part by air, on a round- or circle-trip basis for holiday purposes. Categories of passengers such as company personnel, tour operators' staff, representatives of the press, Authority officials etc. can be included within the 5% alleviation without negating the use of holiday charter mass values.

AMC OPS 1.620(g)

Statistical evaluation of passenger and baggage mass data

See OPS 1.620(g)

1. Sample size (see also Appendix 1 to OPS 1.620(g)).
 - 1.1 For calculating the required sample size it is necessary to make an estimate of the standard deviation on the basis of standard deviations calculated for similar populations or for preliminary surveys. The precision of a sample estimate is calculated for 95% reliability or 'significance', i.e. there is a 95% probability that the true value falls within the specified confidence interval around the estimated value. This standard deviation value is also used for calculating the standard passenger mass.
 - 1.2 As a consequence, for the parameters of mass distribution, i.e. mean and standard deviation, three cases have to be distinguished:
 - a. the true values of the average passenger mass and standard deviation, which are unknown and which are to be estimated by weighing passenger samples.



- b. the 'a priori' estimates of the average passenger mass and the standard deviation, i.e. values resulting from an earlier survey, which are needed to determine the current sample size.
 - c. The estimates for the current true values of m and s , calculated from the sample.
4. Determination of the required sample size and average passenger mass
 - 4.1 Introduction. Standard passenger mass values for mass and balance purposes require passenger weighing programs be carried out. The following example shows the various steps required for establishing the sample size and evaluating the sample data. It is provided primarily for those who are not well versed in statistical computations. All mass figures used throughout the example are entirely fictitious.
 - 4.2 Determination of required sample size. For calculating the required sample size, estimates of the standard (average) passenger mass and the standard deviation are needed. The 'a priori' estimates from an earlier survey may be used for this purpose. If such estimates are not available, a small representative sample of about 100 passengers has to be weighed so that the required values can be calculated.

AMC OPS 1.620(h) & (i)
Adjustment of Standard Masses
 See OPS 1.620(h) & (i)

1. When standard mass values are used, OPS 1.620 (h) and 1.620(i) require the operator to identify and adjust the passenger and checked baggage masses in cases where significant numbers of passengers or quantities of baggage are suspected of exceeding the standard values. This requirement implies that the Operations Manual should contain appropriate directives to ensure that:
 - a. Check-in, operations and cabin staff and loading personnel report or take appropriate action when a flight is identified as carrying a significant number of passengers whose masses, including hand baggage, are expected to exceed the standard passenger mass, and/or groups of passengers carrying exceptionally heavy baggage (e.g. military personnel or sports teams); and
 - b. On small aeroplanes, where the risks of overload and/or CG errors are the greatest, commanders pay special attention to the load and its distribution and make proper adjustments.

AMC to Appendix 1 to OPS 1.620(g)
Guidance on Passenger Weighing Surveys
 See Appendix 1 to OPS 1.620(g), sub-paragraph (c)(4)

1. Operators seeking approval to use standard passenger masses differing from those prescribed in OPS 1.620, Tables 1 and 2, on similar routes or networks may pool their weighing surveys provided that:
 - a. The Authority has given prior approval for a joint survey;
 - b. The survey procedures and the subsequent statistical analysis meet the criteria of Appendix 1 to OPS 1.620(g); and
 - c. In addition to the joint weighing survey results, results from individual operators participating in the joint survey should be separately indicated in order to validate the joint survey results.

AMC to Appendix 1 to OPS 1.620(g)
Guidance on Passenger Weighing Surveys
 See Appendix 1 to OPS 1.620(g)

1. This AMC summarises several elements of passenger weighing surveys and provides explanatory and interpretative information.
2. Information to the Authority. the operator should advise the Authority about the intent of the passenger weighing survey, explain the survey plan in general terms and obtain prior approval to proceed (OPS 1.620(g) refers).
3. Detailed survey plan



- 3.1 The operator should establish and submit for approval to the Authority a detailed weighing survey plan that is fully representative of the operation, i.e. the network or route under consideration and the survey should involve the weighing of an adequate number of passengers (OPS 1.620(g)).
- 3.2 A representative survey plan means a weighing plan specified in terms of weighing locations, dates and flight numbers giving a reasonable reflection of the operator's timetable and/or area of operation (See Appendix 1 to OPS 1.620(g), sub-paragraph (a)(1)).
- 3.3 The minimum number of passengers to be weighed is the highest of the following (See Appendix 1 to OPS 1.620(g) sub-paragraph (a)):
 - a. The number that follows from the general requirement that the sample should be representative of the total operation to which the results will be applied; this will often prove to be the overriding requirement; or
 - b. The number that follows from the statistical requirement specifying the accuracy of the resulting mean values which should be at least 2% for male and female standard masses and 1% for all adult standard masses, where applicable. The required sample size can be estimated on the basis of a pilot sample (at least 100 passengers) or from previous surveys. If analysis of the results of the survey indicates that the requirements on the accuracy of the mean values for male or female standard masses or all adult standard masses, as applicable, are not met, an additional number of representative passengers should be weighed in order to satisfy the statistical requirements.
- 3.4 To avoid unrealistically small samples a minimum sample size of 2000 passengers (males + females) is also required, except for small aeroplanes where in view of the burden of the large number of flights to be weighed to cover 2000 passengers, a lesser number is considered acceptable.
4. Execution of weighing programme
 - 4.1 At the beginning of the weighing programme it is important to note, and to account for, the data requirements of the weighing survey report (See paragraph 7 below).
 - 4.2 As far as is practicable, the weighing programme should be conducted in accordance with the specified survey plan.
 - 4.3 Passengers and all their personal belongings should be weighed as close as possible to the boarding point and the mass, as well as the associated passenger category (male/female/child), should be recorded.
5. Analysis of results of weighing survey
 - 5.1 The data of the weighing survey should be analysed as explained in AMC OPS 1.620(g). To obtain an insight to variations per flight, per route etc. this analysis should be carried out in several stages, i.e. by flight, by route, by area, inbound/outbound, etc. Significant deviations from the weighing survey plan should be explained as well as their possible effect(s) on the results.
6. Results of the weighing survey
 - 6.1 The results of the weighing survey should be summarised. Conclusions and any proposed deviations from published standard mass values should be justified. The results of a passenger weighing survey are average masses for passengers, including hand baggage, which may lead to proposals to adjust the standard mass values given in OPS 1.620 Tables 1 and 2. As stated in Appendix 1 to OPS 1.620(g), sub-paragraph (c), these averages, rounded to the nearest whole number may, in principle, be applied as standard mass values for males and females on aeroplanes with 20 and more passenger seats. Because of variations in actual passenger masses, the total passenger load also varies and statistical analysis indicates that the risk of a significant overload becomes unacceptable for aeroplanes with less than 20 seats. This is the reason for passenger mass increments on small aeroplanes.
 - 6.2 The average masses of males and females differ by some 15 kg or more and because of uncertainties in the male/female ratio the variation of the total passenger load is greater if all adult standard masses are used than when using separate male and female standard masses. Statistical analysis indicates that the use of all adult standard mass values should be limited to aeroplanes with 30 passenger seats or more.
 - 6.3 As indicated in Appendix 1 to OPS 1.620(g), standard mass values for all adults must be based on the averages for males and females found in the sample, taking into account a reference male/female ratio of 80/20 for all flights except holiday charters where a ratio of 50/50 applies. the operator may, based on the data from his weighing programme, or by proving a different male/female ratio, apply for approval



of a different ratio on specific routes or flights.

7. Weighing survey report

7.1 The weighing survey report, reflecting the content of paragraphs 1–6 above, should be prepared in a standard format as follows:

WEIGHING SURVEY REPORT

1 Introduction

- Objective and brief description of the weighing survey

2 Weighing survey plan

- Discussion of the selected flight number, airports, dates, etc.
- Determination of the minimum number of passengers to be weighed.
- Survey plan.

3 Analysis and discussion of weighing survey results

- Significant deviations from survey plan (if any).
- Variations in means and standard deviations in the network.
- Discussion of the (summary of) results.

4 Summary of results and conclusions

- Main results and conclusions.
- Proposed deviations from published standard mass values.

Attachment 1

Applicable summer and/or winter timetables or flight programmes.

Attachment 2

Weighing results per flight (showing individual passenger masses and sex); means and standard deviations per flight, per route, per area and for the total network.

AMC to Appendix 1 to OPS 1.625 Mass and Balance Documentation See Appendix 1 to OPS 1.625

For Performance Class B aeroplanes, the CG position need not be mentioned on the mass and balance documentation if, for example, the load distribution is in accordance with a pre-calculated balance table or if it can be shown that for the planned operations a correct balance can be ensured, whatever the real load is.



This Page Intentionally Left Blank

**AC/AMC K****INSTRUMENTS AND EQUIPMENT****AMC OPS 1.630****Instruments and Equipment - Approval and Installation****See OPS 1.630**

1. For Instruments and Equipment required by OPS 1 Subpart K, “Approved” means that compliance with the applicable TSO design requirements and performance specifications, or equivalent, in force at the time of the equipment approval application, has been demonstrated. Where a TSO does not exist, the applicable airworthiness standards apply unless otherwise prescribed in OPS 1 Subpart M.
2. “Installed” means that the installation of Instruments and Equipment has been demonstrated to comply with the applicable airworthiness requirements of FAR/EASA CS-23/CS-25, or the relevant code used for Type Certification, and any applicable requirement prescribed in OPS 1.
3. Instruments and Equipment approved in accordance with design requirements and performance specifications other than TSOs, before the applicability dates prescribed in OPS 1.001(b), are acceptable for use or installation on aeroplanes operated for the purpose of commercial air transportation provided that any relevant OPS requirement is complied with.
4. When a new version of a TSO (or of a specification other than a TSO) is issued, Instruments and Equipment approved in accordance with earlier requirements may be used or installed on aeroplanes operated for the purpose of commercial air transportation provided that such Instruments and Equipment are operational, unless removal from service or withdrawal is required by means of an amendment to OPS 1 Subpart M.

AMC OPS 1.650/1.652**Flight and Navigational Instruments and Associated Equipment****See OPS 1.650/1.652**

1. Individual requirements of these paragraphs may be met by combinations of instruments or by integrated flight systems or by a combination of parameters on electronic displays provided that the information so available to each required pilot is not less than that provided by the instruments and associated equipment as specified in this Subpart.
2. The equipment requirements of these paragraphs may be met by alternative means of compliance when equivalent safety of the installation has been shown during type certification approval of the aeroplane for the intended kind of operation.

**AMC OPS 1.650/1.652****Flight and Navigational Instruments and Associated Equipment**

See OPS 1.650/1.652

SERIAL		FLIGHTS UNDER VFR			FLIGHTS UNDER IFR OR AT NIGHT		
INSTRUMENT		SINGLE PILOT	TWO PILOTS REQUIRED	MAX T/O AUTH>5700 kg OR MAX PASS>9 Pax	SINGLE-PILOT	TWO PILOTS REQUIRED	MAX T/O MASS AUTH>5700 kg OR MAX PASS>9 Pax
(a)		(b)	(c)	(d)	(e)	(f)	(g)
1	Magnetic Compass	1	1	1	1	1	1
2	Accurate Time Piece	1	1	1	1	1	1
3	OAT Indicator	1	1	1	1	1	1
4	Sensitive Pressure Altimeter	1	2	2	2 Note (5)	2 Note (5)	2 Note (5)
5	Air Speed Indicator	1	2	2	1	2	2
6	Heated Pitot system			2	1	2	2
7	Pitot heat failure Indicator						2
8	Vertical Speed Indicator	1	2	2	1	2	2
9	Turn and slip Indicator OR Turn Co-ordinator	1 Note (1)	2 Notes (1) & (2)	2 Notes (1) & (2)	1 Note (4)	2 Note (4)	2 Note (4)
10	Attitude Indicator	1 Note (1)	2 Notes (1) & (2)	2 Notes (1) & (2)	1	2	2
11	Gyroscopic Direction Indicator	1 Note (1)	2 Notes (1) & (2)	2 Notes (1) & (2)	1	2	2
12	Standby Attitude Indicator						1
13	Mach Number Indicator	See Note (3) for all aeroplanes					

Notes:

- (1) For local flights (A to A, 50 NM radius, not more than 60 minutes duration) the instruments at Serials 9(b) 10(b) and 11 (b) may be replaced by EITHER a turn and slip indicator, OR a turn co-ordinator, OR both an attitude indicator and a slip indicator.
- (2) The substitute instruments permitted by Note (1) shall be provided at each pilot's station.
- (3) Serial 13 - A Mach number indicator is required for each pilot whenever compressibility limitations are not otherwise indicated by airspeed indicators.
- (4) For IFR or at night, a Turn and Slip indicator, or a slip indicator and a third (standby) attitude indicator certificated according to CS 25 or equivalent, is required.
- (5) Neither Three pointers, nor drum pointer altimeters satisfy the requirement.

AMC OPS 1.650(i) & 1.652(i)**Flight and Navigational Instruments and Associated Equipment**

See OPS 1.650(i) & 1.652(i)

A means to indicate outside air temperature indicator may be an air temperature indicator which provides indications that are convertible to outside air temperature.

**AMC OPS 1.650(p)/1.652(s)****Headset, Boom Microphone and Associated Equipment****See OPS 1.650(p)/1.652(s)**

A headset, as required by OPS 1.650(p) and OPS 1.652(s), consists of a communication device which includes an earphone(s) to receive and a microphone to transmit audio signals to the aeroplane's communication system. To comply with the minimum performance requirements, the earphone(s) and microphone should match with the communication system's characteristics and the flight deck environment. The headset should be adequately adjustable to fit the pilot's head. Headset boom microphones should be of the noise cancelling type.

AMC OPS 1.652(d) & (k)(2)**Flight and Navigational Instruments and Associated Equipment****See OPS 1.652(d) & (k)(2)**

A combined pitot heater warning indicator is acceptable provided that a means exists to identify the failed heater in systems with two or more sensors.

AMC OPS 1.668**Airborne Collision Avoidance System****See OPS 1.668**

The minimum performance level for ACAS II is contained in ICAO Annex 10, Volume IV, Chapter 4.

AC OPS 1.680(a)(2)**Quarterly Radiation Sampling****See OPS 1.680(a)(2)**

1. Compliance with OPS 1.680(a)(2) may be shown by conducting quarterly radiation sampling during aeroplane operation using the following criteria:
 - a. The sampling should be carried out in conjunction with a Radiological Agency or similar organisation acceptable to the Authority;
 - b. Sixteen route sectors which include flight above 49000 ft should be sampled every quarter (three months). Where less than sixteen route sectors which include flight above 49000 ft are achieved each quarter, then all sectors above 49000 ft should be sampled.;
 - c. The cosmic radiation recorded should include both the neutron and non-neutron components of the radiation field.
2. The results of the sampling, including a cumulative summary quarter on quarter, should be reported to the Authority under arrangements acceptable to the Authority.

AMC OPS 1.690(b)(6)**Crew Member Interphone System****See OPS 1.690(b)(6)**

1. The means of determining whether or not an interphone call is a normal or an emergency call may be one or a combination of the following:
 - a. Lights of different colours;
 - b. Codes defined by the operator (e.g. Different number of rings for normal and emergency calls);
 - c. Any other indicating signal acceptable to the Authority.

AMC OPS 1.690(b)(7)**Crew Member Interphone System****See OPS 1.690(b)(7)**

At least one interphone system station for use by ground personnel should be, where practicable, so located that the personnel using the system may avoid detection from within the aeroplane.



AC OPS 1.700
Cockpit Voice Recorders
 See OPS 1.700

CVR/CARS Installation Standards Summary

Date	MCTOW					
	Over 27000 kg		Over 5700 kg		Over 2250 kg	
	All aeroplanes	All turbine aeroplanes first certificate of airworthiness	All aeroplanes first certificate of airworthiness	All turbine aeroplanes first certificate of airworthiness	All turbine aeroplanes more than 1 pilot new type certificate	All turbine aeroplanes more than 1 pilot first certificate of airworthiness
1987 →		OPS 1.700(c)	OPS 1.700(b)	N/A		
2003 →						
2016 →	OPS 1.700(a)				OPS 1.700(a)	N/A
2021 →	N/A					

AC OPS 1.710/OPS 1.715
Flight Data Recorders
 See OPS 1.710 and OPS 1.715

FDR/AIR/ADRS/AIRS Installation Standards Summary

Date	MCTOW								
	Over 27000 kg			Over 5700 kg			5700 kg and below		
	All aeroplanes new type certificate	All aeroplanes first certificate of airworthiness	All turbine aeroplanes first certificate of airworthiness	All aeroplanes new type certificate	All aeroplanes first certificate of airworthiness	All turbine aeroplanes first certificate of airworthiness	All turbine aeroplanes new type certificate	All turbine aeroplanes first certificate of airworthiness	Multi-turbine aeroplanes first certificate of airworthiness
1987 →			OPS 1.710(a)			OPS 1.710(a)			
1989 →			OPS 1.710(e)			N/A			
1990 →			OPS 1.710(f)			OPS 1.710(b)			
2005 →									
2016 →	Table A8-1 (Some parameters are sampled at an increased frequency)	OPS 1.710(c)	Table A8-1 (Some parameters are sampled at an increased frequency)	OPS 1.710(c)		OPS 1.710(a)	N/A		
2023 →	OPS 1.710(d)	N/A		OPS 1.710(d)					

AC OPS 1.730(a)(3)
Seats, Seat Safety Belts, Harnesses and Child Restraint Devices
 (See OPS 1.730(a)(3))

1. General

A child restraint device (CRD) is considered to be acceptable if:



- a. It is a 'supplementary loop belt' manufactured with the same techniques and the same materials of the approved safety belts; or
- b. It complies with paragraph 2.

2. Acceptable CRDs

Provided the CRD can be installed properly on the respective aircraft seat, the following CRDs are considered "acceptable":

2.1 Types of CRDs

- a. CRDs approved for use in aircraft only by EASA, the FAA or Transport Canada (on the basis of a national technical standard) and marked accordingly.
- b. CRDs approved for use in motor vehicles according to the UN standard ECE R 44, -03 or later series of Amendments; or
- c. CRDs approved for use in motor vehicles and aircraft according to Canadian CMVSS 213/213.1; or
- d. CRDs approved for use in motor vehicles and aircraft according to US FMVSS No 213 and are manufactured to these standards on or after February 26, 1985. US approved CRDs manufactured after this date must bear the following labels in red lettering:
 - i. "THIS CHILD RESTRAINT SYSTEM CONFORMS TO ALL APPLICABLE FEDERAL MOTOR VEHICLE SAFETY STANDARDS"; and
 - ii. "THIS RESTRAINT IS CERTIFIED FOR USE IN MOTOR VEHICLES AND AIRCRAFT".
- e) CRDs qualified for use in aircraft according to the German "Qualification Procedure for Child Restraint Systems for Use in Aircraft" (TÜV Doc.: TÜV/958-01/2001).

2.2 Devices approved for use in cars manufactured and tested to standards equivalent to those listed in 2.1 (a) to (e) inclusive, which are acceptable to the Authority. The device must be marked with an associated qualification sign, which shows the name of the qualification organisation and a specific identification number, related to the associated qualification project.

2.3 The qualifying organisation shall be a competent and independent organisation that is acceptable to the authority.

3. Location

3.1 Forward-facing CRDs may be installed on both forward- and rearward-facing passenger seats but only when fitted in the same direction as the passenger seat on which it is positioned. Rearward facing CRDs can only be installed on forward-facing passenger seats. A CRD may not be installed within the radius of action of an airbag, unless it is obvious that the airbag is de-activated or it can be demonstrated that there is no negative impact from the airbag.

3.2 A child in a restraint device should be located as near to a floor level exit as feasible.

3.3 A child in a restraint device should be seated in accordance with OPS 1.280 and AMC OPS 1.280, "Passenger Seating" so as to not hinder evacuation for any passenger.

3.4 A child in a restraint device should neither be located in the row leading to an emergency exit nor located in a row immediately forward or aft of an emergency exit. A window passenger seat is the preferred location. An aisle passenger seat or a cross aisle passenger seat is not recommended. Other locations may be acceptable provided the access of neighbour passengers to the nearest aisle is not obstructed by the CRD.

3.5 In general, only one CRD per row segment is recommended. More than one CRD per row segment is allowed if the children are from the same family or travelling group provided the children are accompanied by a responsible person sitting next to them.

3.6 A Row Segment is the fraction of a row separated by two aisles or by one aisle and the aircraft fuselage.



4. Installation
 - 4.1 CRDs shall only be installed on a suitable aircraft seat with the type of connecting device they are approved or qualified for. E.g., CRDs to be connected by a three point harness only (most rearward facing baby CRDs currently available) shall not be attached to an aircraft seat with a lap belt only, a CRD designed to be attached to a vehicle seat by means of rigid bar lower anchorages (ISO-FIX or US equivalent) only, shall only be used on aircraft seats that are equipped with such connecting devices and shall not be attached by the aircraft seat lap belt. The method of connecting must be clearly shown in the manufacturer's instructions to be provided with each CRD.
 - 4.2 All safety and installation instructions must be followed carefully by the responsible person accompanying the infant. Cabin crew should prohibit the use of any inadequately installed CRD or not qualified seat.
 - 4.3 If a forward-facing CRD with a rigid backrest is to be fastened by a lap belt, the restraint device should be fastened when the backrest of the passenger seat on which it rests is in a reclined position. Thereafter, the backrest is to be positioned upright. This procedure ensures better tightening of the CRD on the aircraft seat if the aircraft seat is reclinable.
 - 4.4 The buckle of the adult safety belt must be easily accessible for both opening and closing, and must be in line with the seat belt halves (not canted) after tightening.
 - 4.5 Forward-facing restraint devices with an integral harness must not be installed such that the adult safety belt is secured over the child.
5. Operation
 - 5.1 Each CRD shall remain secured to a passenger seat during all phases of flight, unless it is properly stowed when not in use.
 - 5.2 Where a CRD is adjustable in recline it must be in an upright position for all occasions when passenger restraint devices are required to be used according to OPS 1.320(b)(1).

AMC OPS 1.745

First-Aid Kits

See OPS 1.745

The following should be included in the First-Aid Kits:

Bandages (unspecified)
 Burns dressings (unspecified)
 Wound dressings, large and small
 Adhesive tape, safety pins and scissors
 Small adhesive dressings
 Antiseptic wound cleaner
 Adhesive wound closures
 Adhesive tape
 Disposable resuscitation aid
 Simple analgesic e.g. paracetamol
 AntAMCetic e.g. cinnarizine
 Nasal decongestant
 First-Aid handbook
 Gastrointestinal Antacid +
 Anti-diarrhoeal medication e.g. Loperamide +
 Ground/Air visual signal code for use by survivors.
 Disposable Gloves

A list of contents in at least 2 languages (English and one other). This should include information on the effects and side effects of drugs carried.

Note: An eye irrigator whilst not required to be carried in the first-aid kit should, where possible, be available for use on the ground.

+ For aeroplanes with more than 9 passenger seats installed.

**AMC OPS 1.755****Emergency Medical Kit****See OPS 1.755**

The following should be included in the emergency medical kit carried in the aeroplane:

Sphygmomanometer – non mercury
 Stethoscope
 Syringes and needles
 Oropharyngeal airways (2 sizes)
 Tourniquet
 Coronary vasodilator e.g. nitro-glycerine
 Anti-spasmodic e.g. hyascene
 Epinephrine 1:1000
 Adrenocortical steroid e.g. hydrocortisone
 Major analgesic e.g. nalbuphine
 Diuretic e.g. furosemide
 Antihistamine e.g. diphenhydramine hydrochloride
 Sedative/anticonvulsant e.g. diazepam
 Medication for Hypoglycaemia, hypertonic glucose and/or glucagon
 Antiemetic e.g. metoclopramide
 Atropine
 Digoxin
 Disposable Gloves
 Bronchial Dilator –injectable and inhaled form
 Needle Disposal Box
 Catheter

A list of contents in at least 2 languages (English and one other). This should include information on the effects and side effects of drugs carried.

AMC OPS 1.760**First-aid Oxygen****See OPS 1.760**

1. First-aid oxygen is intended for those passengers who, having been provided with the supplemental oxygen required under OPS 1.770, still need to breathe undiluted oxygen when the amount of supplemental oxygen has been exhausted.
2. When calculating the amount of first-aid oxygen, the operator should take into account the fact that, following a cabin depressurisation, supplemental oxygen as calculated in accordance with Appendix 1 to OPS 1.770 should be sufficient to cope with hypoxic problems for:
 - a. all passengers when the cabin altitude is above 15000 ft; and
 - b. a proportion of the passengers carried when the cabin altitude is between 10000 ft and 15000 ft.
3. For the above reasons, the amount of first-aid oxygen should be calculated for the part of the flight after cabin depressurisation during which the cabin altitude is between 8000 ft and 15000 ft, when supplemental oxygen may no longer be available.
4. Moreover, following cabin depressurisation an emergency descent should be carried out to the lowest altitude compatible with the safety of the flight. In addition, in these circumstances, the aeroplane should land at the first available aerodrome at the earliest opportunity.
5. The conditions above should reduce the period of time during which the first-aid oxygen may be required and consequently should limit the amount of first-aid oxygen to be carried on board.

AMC OPS 1.770**Supplemental Oxygen – Pressurised Aeroplanes****See OPS 1.770**

1. A quick donning mask is the type of mask that:



- a. Can be placed on the face from its ready position, properly secured, sealed, and supplying oxygen upon demand, with one hand and within 5 seconds and will thereafter remain in position, both hands being free;
 - b. Can be put on without disturbing eye glasses and without delaying the flight crew member from proceeding with assigned emergency duties;
 - c. After being put on, does not prevent immediate communication between the flight crew members and other crew members over the aeroplane intercommunication system;
 - d. Does not inhibit radio communications.
2. In determining the supplemental oxygen for the routes to be flown, it is assumed that the aeroplane will descend in accordance with the emergency procedures specified in the Operations Manual, without exceeding its operating limitations, to a flight altitude that will allow the flight to be completed safely (i.e. flight altitudes ensuring adequate terrain clearance, navigational accuracy, hazardous weather avoidance etc.)

AC OPS 1.770(b)(2)(v)**Supplemental Oxygen - Pressurised Aeroplanes (Not Certificated to Fly Above 25000 ft)****See OPS 1.770 (b)(2)(v)**

1. With respect to OPS 1.770(b)(2)(v) the maximum altitude up to which an aeroplane can operate, without a passenger oxygen system installed and capable of providing oxygen to each cabin occupant, should be established using an emergency descent profile which takes into account the following conditions:
 - a. 17 seconds time delay for pilot's recognition and reaction including mask donning, for trouble shooting and configuring the aeroplane for the emergency descent;
 - b. maximum operational speed (V_{MO}) or the airspeed approved in the Aeroplane Flight Manual for emergency descent, whichever is the lesser;
 - c. all engines operative;
 - d. the estimated mass of the aeroplane at the top of climb.
- 1.1 Emergency descent data (charts) established by the aeroplane manufacturer and published in the Aeroplane Operating Manual and/or Aeroplane Flight Manual should be used to ensure uniform application of the rule.
2. On routes where the oxygen is necessary to be carried for 10% of the passengers for the flight time between 10000ft and 13000ft the oxygen may be provided either:
 - a. by a plug-in or drop-out oxygen system with sufficient outlets and dispensing units uniformly distributed throughout the cabin so as to provide oxygen to each passenger at his own discretion when seated on his assigned seat; or
 - b. by portable bottles when a fully trained cabin crew member is carried on board of each such flight.

AMC OPS 1.790**Hand Fire Extinguishers****See OPS 1.790**

1. The number and location of hand fire extinguishers should be such as to provide adequate availability for use, account being taken of the number and size of the passenger compartments, the need to minimise the hazard of toxic gas concentrations and the location of toilets, galleys etc. These considerations may result in the number being greater than the minimum prescribed.
2. There should be at least one fire extinguisher suitable for both flammable fluid and electrical equipment fires installed on the flight deck. Additional extinguishers may be required for the protection of other compartments accessible to the crew in flight. Dry chemical fire extinguishers should not be used on the flight deck, or in any compartment not separated by a partition from the flight deck, because of the adverse effect on vision during discharge and, if non-conductive, interference with electrical contacts by the chemical residues.



3. Where only one hand fire extinguisher is required in the passenger compartments it should be located near the cabin crew member's station, where provided.
4. Where two or more hand fire extinguishers are required in the passenger compartments and their location is not otherwise dictated by consideration of paragraph 1 above, an extinguisher should be located near each end of the cabin with the remainder distributed throughout the cabin as evenly as is practicable.
5. Unless an extinguisher is clearly visible, its location should be indicated by a placard or sign. Appropriate symbols may be used to supplement such a placard or sign.

AMC OPS 1.810

Megaphones

See OPS 1.810

Where one megaphone is required, it should be readily accessible from a cabin crew member's assigned seat. Where two or more megaphones are required, they should be suitably distributed in the passenger cabin(s) and readily accessible to crew members assigned to direct emergency evacuations. This does not necessarily require megaphones to be positioned such that they can be reached by a crew member when strapped in a cabin crew member's seat.

AC OPS 1.820

Emergency Locator Transmitter (ELT)

See OPS 1.820, OPS 1.830(c) and OPS 1.835(b)

1. An Emergency Locator Transmitter (ELT) is a generic term describing equipment which broadcasts distinctive signals on designated frequencies and, depending on application, may be activated by impact or be manually activated. An ELT is one of the following:
 - a. Automatic Fixed (ELT(AF)). An automatically activated ELT which is permanently attached to an aircraft;
 - b. Automatic Portable (ELT(AP)). An automatically activated ELT which is rigidly attached to an aircraft but readily removable from the aircraft;
 - c. Automatic Deployable (ELT(AD)). An ELT, which is rigidly attached to the aircraft and which is automatically deployed and activated by impact, and, in some cases, also by hydrostatic sensors. Manual deployment is also provided;
 - d. Survival ELT (ELT(S)). An ELT which is removable from an aircraft, stowed so as to facilitate its ready use in an emergency, and manually activated by survivors.
2. An automatic portable ELT, (ELT(AP)), as installed in accordance with OPS 1.820, may be used to replace one ELT(S) provided that it meets the ELT(S) requirements. A water-activated ELT(S) is not an ELT(AP).

The judicious choice of numbers of ELTs, their type and placement on aircraft and associated floatable life support systems will ensure the greatest chance of ELT activation in the event of an accident for aircraft operating over water or land, including areas especially difficult for search and rescue. Placement of transmitter units is a vital factor in ensuring optimal crash and fire protection. The placement of the control and switching devices (activation monitors) of automatic fixed ELTs and their associated operational procedures will also take into consideration the need for rapid detection of inadvertent activation and convenient manual switching by crew members.

Note: ADFR may replace an automatic ELB. (see AMC OPS 1.820 below)

AMC OPS 1.820

Automatic deployable flight recorder (ADFR)

(See OPS 1.820(a) note)

The following requirements shall apply to an ADFR:

- deployment shall take place when the aeroplane structure has been significantly deformed;



- deployment shall take place when an aeroplane sinks in water;
- ADFR shall not be capable of manual deployment;
- the ADFR shall be able to float on water;
- the ADFR deployment shall not compromise the safe continuation of the flight;
- the ADFR deployment shall not significantly reduce the chance of survival of the recorder and of successful transmission by its ELT;
- the ADFR deployment shall not release more than one piece;
- an alert shall be made to the flight crew when the ADFR is no longer captive to the aircraft;
- the flight crew shall have no means to disable ADFR deployment when the aircraft is airborne;
- the ADFR shall contain an integrated ELT, which shall activate automatically during the deployment sequence.

Such ELT may be of a type that is activated in-flight and provides information from which a position can be determined; and the integrated ELT of an ADFR shall satisfy the same requirements as an ELT required to be installed on an aeroplane. The integrated ELT shall at least have the same performance as the fixed ELT to maximize detection of the transmitted signal.

Note 1: Refer to the Manual on Location of Aircraft in Distress and Flight Recorder Data Recovery (Doc 10054) for more information on ADFR.

Note 2: If an integrated ELT of a type that is activated in flight is used within an ADFR it could be a means to comply with the requirements of OPS 1.820.

AC OPS 1.821

Location of an Aircraft in Distress

See OPS 1.821

1. Purpose and scope

Location of an aeroplane in distress aims at establishing, to a reasonable extent, the location of an accident site within a 6 NM radius.

2. Operation

- 2.1 An aeroplane in distress shall automatically activate the transmission of information from which its position can be determined by the operator and the position information shall contain a time stamp. It shall also be possible for this transmission to be activated manually. The system used for the autonomous transmission of position information shall be capable of transmitting that information in the event of aircraft electrical power loss, at least for the expected duration of the entire flight.

Note: Guidance on the location of an aeroplane in distress is provided in Attachment K of ICAO Annex 6, Part I.

- 2.2 An aircraft is in a distress condition when it is in a state that, if the aircraft behaviour event is left uncorrected, can result in an accident. Autonomous transmission of position information shall be active when an aircraft is in a distress condition. This will provide a high probability of locating an accident site to within a 6 NM radius. The operator shall be alerted when an aircraft is in a distress condition with an 14 acceptable low rate of false alerts. In case of a triggered transmission system, initial transmission of position information shall commence immediately or no later than five seconds after the detection of the activation event.

Note 1: Aircraft behaviour events can include but are not limited to unusual attitudes, unusual speed conditions, collision with terrain and total loss of thrust/propulsion on all engines and ground proximity warnings.



Note. 2: A distress alert can be triggered using criteria that may vary as a function of aircraft position and phase of flight. Further guidance regarding in-flight event detection and triggering criteria may be found in the EUROCAE ED-237, Minimum Aviation System Performance Specification (MASPS) for Criteria to Detect In-Flight Aircraft Distress Events to Trigger Transmission of Flight Information.

- 2.3 When an aircraft operator or an air traffic service unit (ATSU) has reason to believe that an aircraft is in distress, coordination shall be established between the ATSU and the aircraft operator.
- 2.4 The Authority shall identify the organisations that will require the position information of an aircraft in an emergency phase. These shall include, as a minimum:
 - a. air traffic service unit(s) (ATSU); and
 - b. SAR rescue coordination centre (s) (RCC) and sub-centres.
- 2.5 When autonomous transmission of position information has been activated, it shall only be able to be de-activated using the same mechanism that activated it.
- 2.6 The accuracy of position information shall, as a minimum, meet the position accuracy requirements established for ELTs.

AMC OPS 1.825

Life Jackets

See OPS 1.825

For the purpose of OPS 1.825, seat cushions are not considered to be flotation devices.

AMC OPS 1.830(b)(2)

Life-rafts and ELT for Extended Overwater Flights

See OPS 1.830(b)(2)

1. The following should be readily available with each life-raft:
 - a. Means for maintaining buoyancy;
 - b. A sea anchor;
 - c. Life-lines, and means of attaching one life-raft to another;
 - d. Paddles for life-rafts with a capacity of 6 or less;
 - e. Means of protecting the occupants from the elements;
 - f. A water resistant torch;
 - g. Signalling equipment to make the pyrotechnical distress signals described in ICAO Annex 2;
 - h. 100 g of glucose tablet for each 4, or fraction of 4, persons which the life-raft is designed to carry;
 - i. At least 2 litres of drinkable water provided in durable containers or means of making sea water drinkable or a combination of both; and
 - j. First-aid equipment.
2. As far as practicable, items listed above should be contained in a pack.

AMC OPS 1.835

Survival Equipment

See OPS 1.835

1. The expression 'Areas in which search and rescue would be especially difficult' should be interpreted in the context of this regulation as meaning:
 - a. Areas so designated by the State responsible for managing search and rescue; or
 - b. Areas that are largely uninhabited and where:



- i. The State responsible for managing search and rescue has not published any information to confirm that search and rescue would not be especially difficult; and
- ii. The State referred to in (a) above does not, as a matter of policy, designate areas as being especially difficult for search and rescue.

AMC OPS 1.835(c)
Survival Equipment
See OPS 1.835(c)

1. At least the following survival equipment should be carried when required:
 - a. 2 litres of drinkable water for each 50, or fraction of 50, persons on board provided in durable containers;
 - b. One knife;
 - c. One set of Air/Ground codes;In addition, when polar conditions are expected, the following should be carried:
 - d. A means for melting snow;
 - e. Sleeping bags for use by a third of all persons on board and space blankets for the remainder or space blankets for all passengers on board;
 - f. 1 Arctic/Polar suit for each crew member carried.
2. If any item of equipment contained in the above list is already carried on board the aeroplane in accordance with another requirement, there is no need for this to be duplicated.

**AC/AMC L****COMMUNICATION AND NAVIGATION EQUIPMENT****AMC OPS 1.845****Communication and Navigation Equipment - Approval and Installation****See OPS 1.845**

1. For Communication and Navigation Equipment required by OPS 1 Subpart L, “Approved” means that compliance with the applicable TSO design requirements and performance specifications, or equivalent, in force at the time of the equipment approval application, has been demonstrated. Where a TSO does not exist, the applicable airworthiness standards or equivalent apply unless otherwise prescribed in OPS 1 Subpart M.
2. “Installed” means that the installation of Communication and Navigation Equipment has been demonstrated to comply with the applicable airworthiness requirements of EASA CS-23/CS-25, or the relevant code used for Type Certification, and any applicable requirement prescribed in OPS 1.
3. Communication and Navigation Equipment approved in accordance with design requirements and performance specifications other than TSOs, before the applicability dates prescribed in OPS 1.001(b), are acceptable for use or installation on aeroplanes operated for the purpose of commercial air transportation provided that any relevant OPS requirement is complied with.
4. When a new version of a TSO (or of a specification other than a CS-TSO) is issued, Communication and Navigation Equipment approved in accordance with earlier requirements may be used or installed on aeroplanes operated for the purpose of commercial air transportation provided that such Communication and Navigation Equipment are operational, unless removal from service or withdrawal is required by means of an amendment to OPS 1 Subpart M.

AMC OPS 1.865**Combinations of Instruments and Integrated Flight Systems****See OPS 1.865**

Individual requirements of OPS 1.865 may be met by combinations of instruments or by integrated flight systems or by a combination of parameters on electronic displays provided that the information so available to each required pilot is not less than that provided by the instruments and associated equipment specified.

AC OPS 1.865(d)(1)(i)**IFR Operations Without ADF System****See OPS 1.865(d)(1)(i)**

1. To perform IFR operations without an ADF system installed, the operator should consider the following guidelines on equipment carriage, operational procedures and training criteria.
2. The removal/non installation of ADF equipment from an aeroplane may only be done where it is not essential for navigation, provided that alternative equipment giving equivalent or enhanced navigation capability is carried. This may be accomplished by the carriage of an additional VOR receiver or a GNSS receiver approved for IFR operations.
3. For IFR operations without ADF, the operator should ensure that:
 - a. route segments that rely solely on ADF for navigation are not flown;
 - b. a firm commitment is made not to fly any ADF/NDB procedures;
 - c. that the MEL has been amended to take account of the non-carriage of ADF;
 - d. that the Operations Manual does not reference any procedures based on NDB signals for the aeroplanes concerned;
 - e. that flight planning and dispatch procedures are consistent with the above mentioned criteria.



4. The removal of ADF should be taken into account by the operator in the initial and recurrent training of flight crew.

AC OPS 1.865(f)**FM Immunity Equipment Standards****See OPS 1.865(f)**

1. FM immunity performance Standards for ILS Localizer, VOR receivers and VHF communication receivers have been incorporated in ICAO Annex 10, Volume I - Radio Navigation Aids Fifth Edition dated July 1996, Chapter 3, Paragraphs 3.1.4, 3.3.8 and Volume III, Part II - Voice Communications Systems, Paragraph 2.3.3.
2. Acceptable equipment standards, consistent with ICAO Annex 10, are contained in EUROCAE Minimum Operational Performance Specifications, documents ED-22B for VOR receivers, ED-23B for VHF communication receivers and ED-46B for LOC receivers and the corresponding RTCA documents DO-186, DO-195 and DO-196.

AC OPS 1.865(g)**HF Equipment on Certain NAT HLA Routes****See OPS 1.865(g)**

1. A HF system is considered to be Long Range Communication Equipment.
2. Other two way communication systems may be used if allowed by the relevant airspace procedures.
3. When using one communication system only, the Authority may restrict the NAT HLA approval to the use of the specific routes.

AC OPS 1.870**Additional Navigation Equipment for Operations in NAT HLA Airspace****See OPS 1.870**

1. A Long Range Navigation System may be one of the following:
 - a. One Inertial Navigation System (INS).
 - b. One Global Navigation Satellite System (GNSS).
 - c. One navigation system using inputs from one or more Inertial Reference Systems (IRS), or any other NAT HLA approved sensor system.
2. To conform to the Long range navigation System Specification, a GNSS and its operational use should be approved in accordance with the relevant requirements for NAT HLA airspace.
3. An integrated navigation system which offers equivalent functional availability, integrity and redundancy, when approved may, for the purpose of this requirement, be considered as two independent Long Range Navigation Systems.

AC OPS 1.873**Electronic Navigation Data Management****See OPS 1.873**

1. Terminology
 - a. Navigation Database: Data (such as navigation information, flight planning waypoints, airways, navigation facilities, SID, STAR) that is stored electronically in a system that supports an airborne navigation application.
 - b. Navigation Database Supplier: The meaning of navigation database supplier in OPS 1.873 is equivalent to data application integrator (Refer to EASA OPINION Nr. 01/2005 on "The Acceptance of Navigation Database Suppliers" dated 14 January 2005).



- c. Data Application Integrator: An organisation that incorporates either State AIP (Aeronautical Information Publication) data or a generic database into a format compatible with specific target airborne navigation equipment with a defined intended function. Such organisations require an interface with the equipment design organisation, and are eligible for a Type 2 Letter of Acceptance (LoA) under the Conditions for issuance of LoA for Navigation Database Suppliers by EASA (see paragraph 5.7 of “Guidance to Agency Conditions for Issue of an LoA for Navigation Database Suppliers”). This provides a list of equipment models and part numbers where compatibility has been demonstrated, permitting the supply of navigation databases directly to end users/operators.
- d. Type 2 LoA: LoA granted where a navigation database supplier complies with ED-76/DO-200A and provides data compatible with specified avionics system(s). A Type 2 LoA confirms that the processes for producing navigation data comply with these conditions and the documented Data Quality Requirements for the avionics systems specified. The Data Quality Requirements must be provided by or agreed with the specified equipment design organisation in accordance with a formal arrangement. A Type 2 LoA may release navigation databases directly to end users. Such releases may also include data packing tools, where the use of such tools has been demonstrated to be ED-76/DO-200A compliant. A Type 2 LoA holder may interface directly with data originators (such as State AIP providers and operators), or may use data supplied by a Type 1 LoA, in which case interfaces with data originators may not be necessary.
- e. Type 1 LoA: LoA granted where a navigation database supplier complies with ED-76/DO-200A with no identified compatibility with an aircraft system. A Type 1 LoA confirms that the processes for producing navigation data comply with these conditions and the documented Data Quality Requirements. A Type 1 LoA may not release navigation databases directly to end users.

Note: The term “navigation database supplier” in the Type 1 LoA above is equivalent to “Data Service Provider” as defined in “EASA Conditions for Issue of an LoA for Navigation Database Suppliers”.

- f. Data Service Provider: An organisation (not including the State AIP provider), which collects, originates or processes aeronautical data and provides a navigation database in a generic format (such as ARINC 424). Such organisations are eligible for a Type 1 LoA under the Conditions for issuance of LoA for Navigation Database Suppliers by EASA (see paragraph 5.7 of “Guidance to Agency Conditions for Issue of an LoA for Navigation Database Suppliers”), showing that the generic database has been formatted under controlled conditions.
2. An EASA Type 2 LoA is issued by EASA in accordance with EASA OPINION Nr. 01/2005 on “The Acceptance of Navigation Database Suppliers” dated 14 Jan 05.
 3. The FAA issues a Type 2 LoA in accordance with AC 20-153, while Transport Canada (TCCA) is issuing an Acknowledgement Letter of an Aeronautical Data Process using the same basis. Both acknowledgments are seen to be equivalent to the EASA LoA.
 4. EUROCAE/RTCA document ED-76/DO-200A Standards for Processing Aeronautical Data contains guidance relating to the processes that the supplier may follow.
 5. The ultimate responsibility for ensuring that the data meets the quality for its intended application rests with the end-user of that data. This responsibility can be met by obtaining data from a supplier accredited against this standard by an appropriate organisation. This does not alter the supplier’s responsibility for any functions performed on the data.



This Page Intentionally Left Blank

**AC/AMC M****AEROPLANE MAINTENANCE****AMC OPS 1.875****General****See OPS 1.875**

1. Reference to CAR 145 does not include the components fitted to or intended to be fitted to the aeroplane. Reference should be made to CAP 02 for the certification and acceptance of components.
2. The performance of de-icing and anti-icing activities does not require a CAR 145 approval.
3. Reference should be made to CAR GEN 010(b) for the regulation concerning the maintenance release from an approved organisation considered equivalent to a CAR 145 approved organisation
4. Before an aircraft registered in San Marino may fly it must be issued with a certificate certifying that all required maintenance has been completed in accordance with the requirements of the Authority.

This certification is known as a Certificate of Release to Service (CRS) and it can only be issued by persons approved directly or indirectly by the Authority. Unless notified to the contrary, the Authority will accept the release to service certification of an approved maintenance organisation defined in CAR GEN.010(a).

5. The conditions for the certification of a release to service are defined in CAR GEN Subpart C.

AMC OPS 1.885(a)**Application for and Approval of the Operator's Maintenance System****See OPS 1.885(a)**

1. The Authority does not expect the documents listed in OPS 1.185(b) to be submitted in a completed state with the initial application for grant or variation since each will require approval in its own right and may be subject to amendment as a result of Authority assessment during the technical investigations. Draft documents should be submitted at the earliest opportunity so that investigation of the application can begin. Grant or variation cannot be achieved until the Authority is in possession of completed documents.
2. This information is required to enable the Authority to conduct its investigation into the application, to assess the volume and complexity of work proposed and the locations at which it will be accomplished.
3. The applicant should inform the Authority where base and scheduled line maintenance is to take place and give details of any contracted maintenance which is in addition to that provided in response to OPS 1.895(a) or (c).
4. At the time of application, the operator should have arrangements for all base and scheduled line maintenance in place for an appropriate period of time, as acceptable to the Authority. The operator should establish further arrangements in due course before the maintenance is due. Base maintenance contracts for high-life time checks may be based on one time contracts, when the Authority considers that this is compatible with the operator's fleet size.

AMC OPS 1.885(b)**Application for and Approval of the Operator's Maintenance System****See OPS 1.885(b)**

1. The approval of the operator's maintenance system will be indicated by means of a statement containing the following information:
 - a. Air Operator Certificate number;
 - b. Name of the operator;
 - c. Type(s) of aeroplane for which the maintenance system has been accepted;



- d. Reference identification of the operator's approved aeroplane maintenance programme(s) related to c. above;
- e. Reference identification of the operator's approved maintenance management exposition; and
- f. Any limitations imposed by the Authority on the grant or variation.

Note: Approval may be limited to specified aeroplanes, to specific locations or by other means like operational limitations if considered necessary by the Authority in the interests of safe operation.

AMC OPS 1.890(a)
Maintenance Responsibility
See OPS 1.890(a)

1. The requirement means that the operator is responsible for determining what maintenance is required, when it has to be performed and by whom and to what standard, in order to ensure the continued airworthiness of the aircraft being operated.
2. The operator should therefore have adequate knowledge of the design status (type-specification, customer options, airworthiness directives, modifications, operational equipment) and required and performed maintenance. Status of aeroplane design and maintenance should be adequately documented to support the performance of the Quality System (See OPS 1.900).
3. The operator should establish adequate co-ordination between flight operations and maintenance to ensure that both will receive all information on the condition of the aircraft necessary to enable both to perform their tasks.
4. The requirement does not mean that the operator himself performs the maintenance (this is to be done by a CAR 145 Approved/Accepted Maintenance Organisation (See OPS 1.895) but that the operator carries the responsibility for the airworthy condition of aircraft it operates and thus should be satisfied before the intended flight that all required maintenance has been properly carried out.
5. When the operator is not appropriately approved in accordance with CAR 145, the operator should provide a clear work order to the maintenance contractor. The fact that the operator has contracted a CAR 145 Approved/Accepted Maintenance Organisation should not prevent him from checking at the maintenance facilities on any aspect of the contracted work if he wishes to do so to satisfy his responsibility for the airworthiness of the aircraft.

AMC OPS 1.890(a)(1)
Maintenance Responsibility
See OPS 1.890(a)(1)

1. With regard to the pre-flight inspection it is intended to mean all of the actions necessary to ensure that the aeroplane is fit to make the intended flight. These should typically include but are not necessarily limited to:
 - a. A walk-around type of inspection of the aeroplane and its emergency equipment for condition including, in particular, any obvious signs of wear, damage or leakage.
 - b. Inspection of the technical log to ensure that the intended flight is not adversely affected by any outstanding deferred defects and that no required maintenance action shown in the maintenance statement is overdue or will become due during the flight.
 - c. That consumable fluids, gases etc. uplifted prior to flight are of the correct specification, free from contamination, and correctly recorded.
 - d. That all doors are securely fastened.
 - e. Control surface and landing gear locks, pitot/static covers, restraint devices and engine/aperture blanks have been removed.
 - f. That all the aeroplane's external surfaces and engines are free from ice, snow, sand, dust etc.



2. Tasks such as oil and hydraulic fluid uplift and tyre inflation may be considered as part of the pre-flight inspection, if acceptable to the Authority. The related pre-flight inspection instructions should address the procedures to determine where the necessary uplift or inflation results from an abnormal consumption and possibly requires additional maintenance action by the CAR 145 approved/accepted Maintenance Organisation.
3. The operator should publish guidance to maintenance and flight personnel and any other personnel performing pre-flight inspection tasks, as appropriate, defining responsibilities for these actions and, where tasks are contracted to other organisations, how their accomplishment is subject to the Quality System of OPS 1.900. It should be demonstrated to the Authority that pre-flight inspection personnel have received appropriate training for the relevant pre-flight inspections tasks. The training standard for personnel performing the pre-flight inspection should be described in the operator's maintenance management exposition.

AMC OPS 1.890(a)(1)
Maintenance Responsibility
See OPS 1.890(a)(1)

The fact that the performance of pre-flight inspections is the operator's maintenance responsibility does not necessarily mean that such personnel performing pre-flight inspection tasks report to the nominated postholder for continuing airworthiness, but that the nominated postholder for continuing airworthiness is responsible for determining the content of the pre-flight inspection and setting the qualification standard of the involved personnel. In addition, compliance with the qualification standard should be monitored by the operator's Quality System.

AMC OPS 1.890(a)(2)
Maintenance Responsibility
See OPS 1.890(a)(2)

The operator should have a system to ensure that all defects affecting the safe operation of the aeroplane are rectified within the limits prescribed by the approved MEL or CDL as appropriate and that no postponement of such a defect rectification beyond the approved limits can be permitted unless with the operator's agreement and in accordance with a procedure approved by the Authority.

AMC OPS 1.890(a)(3)
Maintenance Responsibility
See OPS 1.890(a)(3)

The operator should have a system to ensure that all aeroplane maintenance checks are performed within the limits prescribed by the approved aeroplane maintenance programme and that, whenever a maintenance check cannot be performed within the required time limit, its postponement is allowed with the operator's agreement and in accordance with a procedure approved by the Authority.

AMC OPS 1.890(a)(4)
Maintenance Responsibility
See OPS 1.890(a)(4)

The operator should have a system to analyse the effectiveness of the maintenance programme, with regard to spares, established defects, malfunctions and damage, and to amend the maintenance programme accordingly (this amendment will involve the approval of the Authority unless the operator has been approved to amend the maintenance programme without direct involvement of the Authority).

AMC OPS 1.890(a)(5)
Maintenance Responsibility
See OPS 1.890(a)(5)

"Any other continued airworthiness requirement made mandatory by the Authority" includes Type Certification related requirements such as: Certification Maintenance Requirements (CMR's), Life Limited Parts, Airworthiness Limitations, etc. For the purposes of this statement, "made mandatory by the Authority" refers to those mandatory requirements, such as airworthiness directives (ADs) prescribed for that aircraft or product by the State of type certification on which the Type Acceptance Certificate refers.



The Authority may from time to time issue an Additional Airworthiness Directive (AAD) to address an urgent safety concern and may additionally vary the requirements of a State of type acceptance AD. In this case the AAD will take precedence.

AMC OPS 1.890(a)(6)
Maintenance Responsibility
See OPS 1.890(a)(6)

Repairs or modifications of any part of the aircraft, or of its equipment, should be carried out in accordance with the Type Certificate holder, Supplemental Type Certificate holder instructions or those instructions provided as part of an approval under CAR 21 Subpart C.

Modification and repair data approved in accordance with CAR 21 Subpart C regulations are acceptable to the Authority.

In addition the operator should establish a policy to assess non-mandatory information relevant to the airworthiness of the aircraft operated. This includes Service Bulletins, Service Letters and may include other information published by the aircraft, engine and component type design organisations or related airworthiness authorities.

AMC OPS 1.895(a)
Maintenance Management
See OPS 1.895(a)

1. Where the operator is not itself approved to CAR 145 or the operator's maintenance organisation is a different legal entity, a contract should be agreed between the operator and the CAR 145 Approved Maintenance Organisation that specifies, in detail, the work to be performed by the CAR 145 Approved Maintenance Organisation.
2. In any contract, both the specification of work and the assignment of responsibilities should be clear, unambiguous and sufficiently detailed to ensure that no misunderstanding should arise between the parties concerned (operator, maintenance organisation and the Authority) that could result in a situation where work that has a bearing on the airworthiness or serviceability of aircraft is not or will not be properly performed.

Example of Contract Contents

The following paragraphs are not intended to provide a standard maintenance contract but to provide a list of the main points that should be addressed, where applicable, in a maintenance contract between an operator and a CAR 145 approved or accepted maintenance organisation. As only the technical parts of the maintenance contracts must be acceptable to the CAA, the following paragraphs only address technical matters and exclude matters such as costs, delay, warranty, etc.

When maintenance is contracted to more than one CAR 145 approved organisation (for example aircraft base maintenance to X, engine maintenance to Y and line maintenance to Z1, Z2 & Z3), attention should be paid to the consistency of the different maintenance contracts.

A maintenance contract is not normally intended to provide appropriate detailed work instruction to the personnel (and is not normally distributed as such). Accordingly, there should be established organisational responsibility, procedures and routines in the operator's Maintenance Management Exposition (MME) and the CAR 145 organisations Maintenance Organisation Exposition (MOE) to take care of these functions in a satisfactory way such that any person involved is informed about his/her responsibility and the procedures which apply. These procedures and routines can be included/appended to the operator's MME and maintenance organisation's MOE or consist in separate procedures. In other words, procedures and routines should reflect the conditions of the contract.

a. Aircraft/Engine Maintenance

The following subparagraphs may be adapted to include in a maintenance contract that applies to aircraft base maintenance, aircraft line maintenance and engine maintenance.

Aircraft maintenance also includes the maintenance of the engines and APU while they are installed on the aircraft.

b. Scope of Work



The type of maintenance to be performed by the CAR 145 approved organisation should be clearly specified. In the case of line and/or base maintenance, the contract should specify the aircraft type, engines and, preferably include the aircraft's registrations. In the case of engine maintenance performed off-wing, the contract should specify the engine type.

c. Locations Identified for the Performance of Maintenance

The place(s) where base, line or engine maintenance, as applicable, will be performed should be specified. The approval certificate held by the maintenance organisation at the place(s) where the maintenance will be performed should be referred to in the contract. If necessary the contract may address the possibility of performing maintenance at any location subject to the need for such maintenance arising either from the unserviceability of the aircraft or from the necessity of supporting occasional line maintenance.

d. Sub-Contracting

The maintenance contract should specify under which conditions the CAR 145 approved organisation may sub-contract tasks to a third party (whether this third party is CAR 145 approved/accepted or not). The contract as a minimum should make reference to CAR 145.125(2). In addition, the operator may require the CAR 145 approved organisation to obtain the operator's approval before subcontracting to a third party. Access should be given to the operator regarding any information (especially the quality monitoring information) about the CAR 145 approved organisation's subcontractors involved in the contract. It should however be noted that under the operator's responsibility both the operator and the CAA are entitled to be fully informed about subcontracting, although the CAA will normally only be concerned with aircraft, engine and APU subcontracting

e. Maintenance Programme

The maintenance programme under which the maintenance is to be performed must be specified.

f. Quality Monitoring

The terms of the contract should include a provision allowing the operator to perform quality surveillance (including audits) upon the CAR 145 approved organisation. The maintenance contract should specify how the results of the quality surveillance/audits are considered by the CAR 145 approved organisation (See also paragraph 2.w.v). – 'Meetings').

g. Airworthiness Data

The airworthiness data used for the purpose of this contract should be specified. This may include, but not limited to:

- Maintenance Programme
- Airworthiness Directive
- Major repairs/modification data
- Aircraft Maintenance Manual
- Component Maintenance Manuals, e.g. galley, seats, equipment etc.
- Aircraft and equipment IPCs
- Wiring Diagrams
- Trouble Shooting Manual
- Minimum Equipment List
- Operations Manual



- Flight Manual
- Engine Maintenance Manual
- Engine Overhaul Manual
- Maintenance Management Exposition

h. Incoming Conditions

The contract should specify in which condition the operator should send the aircraft to the CAR 145 approved organisation. For checks of significance e.g. 'C' checks and above, it may be beneficial that a work scope planning meeting be organised so that the tasks to be performed may be commonly agreed (see also paragraph 2.w.ii) - 'Meetings').

i. Airworthiness Directives and Service Bulletins

The contract should specify what information the operator is responsible to provide to the CAR 145 approved organisation, such as the due date of the airworthiness directives (ADs), the selected means of compliance, the decision to embody Service Bulletins (SBs) or modification, etc. In addition, the type of information the operator will need in return to complete the control of ADs and modification status should be specified.

j. Hours and Cycle Control

Hours and cycles control is the responsibility of the operator, but there may be cases where the CAR-145 approved organisation should receive the current flight hours and cycles on a regular basis so that it may update the records for its own planning functions (see also paragraph v. - 'Exchange of information').

k. Service Life Limited Components

Service life-limited components control is the responsibility of the operator. The CAR 145 approved organisation will have to provide the operator with all the necessary information about the service life-limited components removal/installation so that the operator may update its records (see also paragraph v. - 'Exchange of Information')

l. Supply of Parts

The contract should specify whether a particular type of material or component is supplied by the operator or by the contracted CAR 145 or accepted/approved organisation, which type of component is pooled, etc. The contract should clearly state that it is the contracted maintenance provider's responsibility to be satisfied that the component in question meets the approved data/standard and to ensure that the aircraft component is in a satisfactory condition for installation. A contracted maintenance organisation cannot simply accept whatever is supplied by the operator. Additional guidance is provided in CAP 02 Chapter 28 for the acceptance of components and this should be reflected in the contract.

m. Pooled Parts

If applicable, the contract should specify how the subject of pooled parts at Line Stations are addressed.

n. Scheduled Maintenance

For the planning scheduled maintenance checks, the support documentation to be given to the CAR 145 approved organisation should be specified. This may include, but may not be limited to:

- Applicable work package, including work/task cards
- Scheduled component removal list
- Modifications to be incorporated



- Service Bulletin and special maintenance requests

When the CAR 145 approved organisation determines, for any reason, to defer a maintenance task, it must be formally agreed with the operator. If the deferment goes beyond an approved limit, refer to paragraph q - 'Deviation from the Maintenance Programme'. This should be addressed, where applicable, in the maintenance contract.

- o. **Unscheduled Maintenance/Defect Rectification**

The contract should specify to which level the CAR 145 approved organisation may rectify a defect without reference to the operator. As a minimum, the approval and incorporation of major repairs should be addressed. The deferment of any defect rectification should be submitted to the operator and, if applicable, to the CAA.

- p. **Deferred Tasks**

See paragraphs n. and o. above. In addition, for aircraft line and base maintenance the use of the operator's MEL and the relation with the operator in case of a defect that cannot be rectified at the line station should be addressed.

- q. **Deviation from the Maintenance Programme**

Deviations, or variations to the Maintenance Programme must be requested by the operator to the CAA or granted by the operator in accordance with a procedure acceptable to the CAA. The contract should specify the support the CAR 145 approved organisation may provide to the operator to substantiate the deviation or variation request.

- r. **Test Flight**

If any test flight is required after aircraft maintenance, it should be performed in accordance with the procedures established in the operator's Maintenance Management Exposition.

- s. **Engine Testing**

The contract should specify the acceptability criterion for engine testing and whether a representative of the operator should witness an engine undergoing test.

- t. **Release to Service Documentation**

The release to service must be performed by the CAR145 approved/accepted organisation in accordance with its MOE procedures, CAR GEN Subpart C and the guidance contained in the applicable CAA Information Circular. The contract should, however, specify which support forms must be used (Operator's technical log, CAR 145 approved organisation's maintenance visit file, etc.) and the documentation the CAR 145 approved/accepted organisation should provide to the operator upon delivery of the aircraft.

This may include but not limited to:

- Certificate of Release to Service – mandatory
- Flight Test Report
- List of modifications embodied
- List of Service Bulletins embodied/satisfied
- List of repairs carried out
- List of Airworthiness Directives incorporated
- Maintenance visit report
- Bench test reports



- Release certifications for components fitted, e.g. EASA Form 1, FAA Form 8130-3

u. Continuing Airworthiness Records

The operator may contract the CAR 145 approved organisation to retain some of the continuing airworthiness records required by CAR OPS 1 Subpart M. It should be ensured that every requirement of CAR OPS 1.920 is fulfilled by either the operator or the CAR 145 approved organisation. In such a case, uninhibited and ready access to the above-mentioned records should be given by the CAR 145 approved organisation to the operator and the CAA.

v. Exchange of Information

Each time exchange of information between the operator and the CAR 145 approved organisation is necessary, the contract should specify what information should be provided and when (i.e. on what occasion or at what frequency), how, by whom and to whom it must be transmitted.

w. Meetings

For the CAA to be satisfied that a good communication system exists between the operator and the CAR 145 approved organisation, the terms of the maintenance contract should include the provision for a certain number of meetings to be held between both parties. The contract should state that minutes will be taken, circulated to named persons and held on file by both organisations.

i) Contract Review

Before the contract is applicable and valid, it is important for the technical personnel of both parties that are involved in the application of the contract to meet in order to be sure that every point leads to a common understanding of the duties and responsibilities of both parties.

ii) Work Scope Planning Meeting

Work scope planning meetings may be organised so that the tasks to be performed are commonly agreed.

iii) Technical Meeting

Scheduled meetings may be organised in to review, on a regular basis, technical matters such as ADs, SBs, future modifications, major defects found during maintenance check, reliability, etc.

iv) Quality Meeting

Quality meetings may be organised to examine matters raised by the operator's quality surveillance and to agree upon necessary corrective actions.

v) Reliability Meeting

When a reliability programme exists, the contract should specify the operator's and CAR 145 approved organisation's respective involvement in that programme, including the participation in reliability meetings.

- x. The terms of the contract shall include a provision allowing the San Marino CAA to conduct periodic and unannounced surveillance of the AOC Contracted Maintenance.

3. The Authority is required to find the contract(s) acceptable to them, and especially that the contract allows the operator to properly exercise its maintenance responsibility. Those parts of a contract that have no bearing on the technical or operational aspects of airworthiness are outside the scope of this paragraph.



AMC OPS 1.895(b)
Maintenance Management
See OPS 1.895(b)

1. The person or group of persons employed should represent the maintenance management structure of the operator (for maintenance) and be responsible for all maintenance and continuing airworthiness functions. Dependent on the size of the operation and the organisational set-up, the maintenance and continuing airworthiness functions may be divided under individual managers or combined in nearly any number of ways. This includes combining the functions of 'Accountable Manager' (see OPS 1.175(h)), the 'nominated postholder' (see OPS 1.175(i)) and the quality monitoring function (see OPS 1.900) so long as the quality monitoring function remains independent of the functions to be monitored. In the smallest organisation this may lead to the quality monitoring function being performed by the Accountable Manager if suitably qualified. Consequently the smallest organisation consists of at least two persons except that the Authority may agree to the quality monitoring function being sub-contracted to another operator's quality monitoring department or a suitably qualified independent person acceptable to the Authority.
2. The actual number of persons to be employed and their necessary qualifications is dependent upon the tasks to be performed and thus dependent on the size and complexity of the operation (route network, line or charter, EDTO, number of aircraft and the aircraft types, complexity of the aircraft and their age), number and locations of maintenance facilities and the amount and complexity of maintenance contracting. Consequently, the number of persons needed, and their qualifications, may differ greatly from one operator to another and a simple formula covering the whole range of possibilities is not feasible.
3. To enable the Authority to accept the number of persons and their qualifications, the operator should make an analysis of the tasks to be performed, the way in which he intends to divide and/or combine these tasks, indicate how he intends to assign responsibilities and establish the number of man/hours and the qualifications needed to perform the tasks. With significant changes in the aspects relevant to the number and qualifications of persons needed, this analysis should be updated.
4. The authority does not necessarily expect that the credentials of each person of the Maintenance Management Group of Persons are individually submitted to the Authority for their acceptance. However, the manager of the Maintenance Management Group of Persons, and any manager reporting directly to him should be individually acceptable to the Authority.

AMC OPS 1.895(c)
Maintenance Management
See OPS 1.895(c)

This situation is normally only applicable to small operators of aircraft under 5700 kg maximum mass. The Authority should only accept that the proposed person be employed by the CAR 145 or EASA approved Part M Organisation when it is manifest that he/she is the only available competent person in a position to exercise this function, within a practical working distance from the operator's offices

AMC OPS 1.895(c)
Maintenance Management
See OPS 1.895(c)

This paragraph only applies to contracted maintenance and therefore does not affect situations where the CAR 145 approved/accepted organisation and the operator are the same organisation.

AMC OPS 1.895(d)
Maintenance Management
See OPS 1.895(d)

1. In the case of continuing airworthiness tasks, special attention should be paid to procedures and responsibilities to ensure that all maintenance work is performed, Service Bulletins are analysed and decisions taken on accomplishment, airworthiness directives are received, analysed, completed on time, recorded and that all work, including non-mandatory modifications is carried out to approved data and to the latest standards.



AMC OPS 1.895(e)
Maintenance Management
See OPS 1.895(e)

1. In the case of a contract with an organisation to carry out continuing airworthiness functions, the operator's maintenance management exposition should include appropriate procedures to ensure that all required maintenance is ultimately performed on time by CAR 145 approved/accepted organisations in accordance with data acceptable to the Authority. In particular the Quality System procedures should place great emphasis on monitoring compliance with the above. The list of all contracted organisations, or a reference to this list, should be included in the operator's maintenance management exposition.
2. Such a maintenance arrangement does not absolve the operator from its overall Maintenance responsibility. Specifically, in order to accept the maintenance arrangement, the Authority should be satisfied that such an arrangement allows the operator to ensure full compliance with OPS 1.890 - Maintenance Responsibility.

AMC OPS 1.895(f & g)
Maintenance Management
See OPS 1.895(f & g)

The intent of this paragraph is that maintenance contracts are not necessary when the operator's maintenance system, as approved by the Authority, specifies that the relevant maintenance activity may be ordered through one time work orders. This includes for obvious reasons occasional line maintenance and may also include aeroplane component maintenance up to engines, so long as the Authority considers that the maintenance is manageable through work orders, both in term of volume and complexity. It should be noted that this paragraph implies that even where base maintenance is ordered on a case by case basis, there must be a written maintenance contract.

AMC OPS 1.895(h)
Maintenance Management
See OPS 1.895(h)

Office accommodation in this case means office accommodation such that the incumbents, whether they are maintenance management, planning, technical records or quality staff, can carry out their designated tasks in a manner that contributes to good maintenance standards. In the smaller operators, the Authority may agree to these tasks being conducted from one office subject to being satisfied that there is sufficient space and that each task can be carried out without undue disturbance. Office accommodation should also include an adequate technical library and room for document consultation.

AMC OPS 1.900
Quality System
See OPS 1.900

1. The operator should establish a plan acceptable to the Authority to show when and how often the activities as required by OPS 1.890 will be monitored. In addition, a Quality Audit Plan must be provided and reports should be produced at the completion of each monitoring investigation and include details of discrepancies and non-compliance with procedures or requirements.
2. The feedback part of the system should address who is required to rectify discrepancies and non-compliance in each particular case and the procedure to be followed if rectification is not completed within appropriate timescales. The procedure should lead to the Accountable Manager specified in OPS 1.175(h).
3. To ensure effective compliance with OPS 1.900 the following elements have been shown to work well:
 - a. Product sampling – the part inspection of a representative sample of the aeroplane fleet;
 - b. Defect sampling – the monitoring of defect rectification performance;
 - c. Concession sampling – the monitoring of any concession to not carry out maintenance on time;
 - d. On time maintenance sampling – the monitoring of when (flying hours/calendar time/flight cycles etc.) aeroplanes and their components are brought in for maintenance;
 - e. Sampling reports of unairworthy conditions and maintenance errors.

Note: OPS 1.900 includes other self-explanatory monitoring elements.



AMC OPS 1.900
Quality System
See OPS 1.900

The primary purpose of the Quality System is to monitor compliance with the approved procedures specified in the operator's Maintenance Management Exposition to ensure compliance with Subpart M and thereby ensure the maintenance aspects of the operational safety of the aeroplanes. In particular, this part of the Quality System provides a monitor of the effectiveness of maintenance, reference OPS 1.890, and should include a feedback system to ensure that corrective actions are both identified and carried out in a timely manner.

AMC OPS 1.905(a)
Maintenance Management Exposition
See OPS 1.905(a)
See Appendix 1 to AMC OPS 1.905(a)

1. The purpose of the maintenance management exposition is to set forth the procedures, means and methods of the operator. Compliance with its contents will assure compliance with OPS 1 Subpart M requirements and is a pre-requisite for obtaining an acceptance of the operator's maintenance system by the Authority.
2. Where the operator is appropriately approved as a CAR 145 approved maintenance organisation the exposition of the maintenance organisation may form the basis of the operator's maintenance management exposition in a combined document . Appendix 1 to AMC OPS 1.905(a) provides a suggested format and required contents
3. Where the operator is not approved in accordance with CAR 145 but has a maintenance contract with a CAR 145 Approved Maintenance Organisation, Appendix 1 to AMC OPS 1.905(a) provides a suggested format and required contents for the maintenance management exposition.
4. Personnel are expected to be familiar with those parts of the exposition that are relevant to the maintenance and continuing airworthiness co-ordination work they carry out.
5. The operator will need to specify in the exposition who should amend the document, particularly where there are several parts.
6. The person responsible for the management of the Quality System should be responsible for monitoring and amending the exposition unless otherwise agreed by the Authority, including associated procedures manuals, and the submission of proposed amendments to the Authority for approval. The Authority may agree a procedure, which will be stated in the amendment control section of the Exposition, defining the class of amendments which can be incorporated without the prior consent of the Authority.
7. The operator may use Electronic Data Processing (EDP) for publication of the maintenance management exposition. The maintenance management exposition should be made available to the Authority in a form acceptable to the Authority. Attention should be paid to the compatibility of EDP publication systems with the necessary dissemination of the maintenance management exposition, both internally and externally.
8. Part 0 "General Organisation" of the maintenance management exposition should include a corporate commitment by the operator, signed by the Accountable Manager confirming that the maintenance management exposition and any associated manuals define the organisation compliance with OPS 1 Subpart M and will be complied with at all times.
9. The Accountable Manager's exposition statement should embrace the intent of the following paragraph and in fact this statement may be used without amendment. Any modification to the statement should not alter the intent:

"This exposition defines the organisation and procedures upon which the Authority approval under OPS 1 Subpart M is based.

These procedures are approved by the undersigned and must be complied with, as applicable, in order to ensure that all maintenance of(*quote operator's name*)..... fleet of aircraft is carried out on time to an approved standard.

It is accepted that these procedures do not override the necessity of complying with any new or amended regulation published by the Authority from time to time where these new or amended regulations are in conflict with these procedures.



It is understood that the Authority will approve this organisation whilst the Authority is satisfied that the procedures are being followed and the work standard maintained. It is understood that the Authority reserves the right to suspend, vary or revoke the OPS Subpart M maintenance system approval of the organisation, as applicable, if the Authority has evidence that the procedures are not followed and the standards not upheld.

It is further understood that suspension or revocation of the approval of the maintenance system would invalidate the AOC.

Signed

Dated

Accountable Manager and ...(*quote position*).....

For and on behalf of(*quote organisation's name*)..... "

- 10. Whenever the Accountable Manager is changed it is important to ensure that the new Accountable Manager signs the paragraph 9 statement at the earliest opportunity as part of the acceptance by the Authority.

Failure to carry out this action invalidates the CAR OPS 1 Subpart M approval.

Appendices 1 and 2 contain examples of exposition lay-outs.

AMC OPS 1.910(a)
Operator's Aeroplane Maintenance Programme
 See OPS 1.910(a)

- 1. The aeroplane maintenance programme is the responsibility of the operator and therefore should be managed and presented by the operator to the Authority.
- 2. Where implementation of the content of an approved operator's aeroplane maintenance programme is accomplished by an appropriately approved CAR 145 Approved Maintenance Organisation. The CAR 145 Approved Maintenance Organisation should have access to the relevant parts of the approved operator's aeroplane maintenance programme. Implementation means preparation and planning of the maintenance tasks in accordance with the approved maintenance programme.
- 3. The aeroplane should only be maintained to one approved operator's aeroplane maintenance programme at a given point in time. Where the operator wishes to change from one approved operator's aeroplane maintenance programme to another such approved maintenance programme, a transfer Check/Inspection may need to be performed, as agreed with the Authority, in order to implement the change.
- 4. The operator's aeroplane maintenance programme should contain a preface which will define the maintenance programme contents, the inspection standards to be applied, permitted variations to task frequencies and, where applicable, any procedure to escalate established check/inspection intervals. Appendix 1 to AMC OPS 1.910(a) & (b) provides detailed guidance on the content of an approved operator's aeroplane maintenance programme.
- 5. Where the operator wishes to use an aeroplane with the initial operator's aeroplane maintenance programme based upon the Maintenance Review Board Report (MRBR) process, any associated programme for the continuous surveillance of the reliability, or health monitoring of the aeroplane should be considered as part of the aeroplane maintenance programme.
- 6. Where an aeroplane type has been subjected to the MRBR process, the Authority would normally require the operator to develop the initial operator's aeroplane maintenance programme based upon the MRBR.
- 7. The documentation supporting the development of operator's aeroplane maintenance programmes for aeroplane types subjected to the MRBR process should contain identification cross reference to the MRBR tasks such that it is always possible to relate such tasks to the current approved operator's aeroplane maintenance programme. This does not prevent the approved operator's aeroplane maintenance programme from being developed in the light of service experience to beyond the MRBR recommendations but will show the relationship to such recommendations.



8. Some approved operator's aeroplane maintenance programmes, not developed from the MRB Process, utilise reliability programmes. Such reliability programmes should be considered as a part of the approved maintenance programme.
9. Reliability programmes should be developed for aeroplane maintenance programmes based upon MSG logic or those that include condition monitored components or that do not contain overhaul time periods for all significant system components.
10. Reliability programmes need not be developed for aeroplane maintenance programmes of aeroplanes of 5700 kg and below or that do contain overhaul time periods for all significant system components.
11. The purpose of a reliability programme is to ensure that the aeroplane maintenance programme tasks are effective and their periodicity is adequate. It therefore follows that the actions resulting from the reliability programme may be not only to escalate or delete maintenance task, but also to de-escalate or add maintenance tasks, as necessary.
12. A reliability programme provides an appropriate means of monitoring the effectiveness of the maintenance programme.

AMC OPS 1.910(f)**Operator's Aeroplane Maintenance Programme****See OPS 1.910(f)**

The operator should review the detailed requirements at least annually. A record of such reviews should be retained by the operator.

AMC OPS 1.910(g)**Operator's Aeroplane Maintenance Programme****See OPS 1.910(g)**

Notwithstanding AMC OPS 1.910(g) the operator is to review mandatory information before compliance is required. Such information includes but is not limited to:

1. Airworthiness Limitations include applicable mandatory replacement times of life limited parts, structural inspection intervals together with related structural inspection procedures.
2. Maintenance considerations such as Certification Maintenance Requirements/Certification Check Requirements) and applicable mandatory tasks intended to detect latent safety-significant failures.

AMC OPS 1.910(h)**Operator's Aeroplane Maintenance****See OPS 1.910(h)**

1. The documentation issued by the Authority to approve the operator's aeroplane maintenance programme may include details of who may issue certificates of release to service in a particular situation and may define which tasks are considered as base maintenance activity. Development of the approved operator's aeroplane maintenance programme is dependent upon sufficient satisfactory in-service experience which has been properly processed. In general, the task being considered for escalation beyond the MRB limits should have been satisfactorily repeated at the existing frequency several times before being proposed for escalation.
2. The Authority may approve a part of or an incomplete operator's aeroplane maintenance programme at the start of operation of a new aeroplane type or a new operator, subject to the limitation that the approved operator's aeroplane maintenance programme is only valid for a period that does not exceed any required maintenance not yet approved. The following examples illustrate just two possibilities:
 - 2.1 A new aeroplane type may not have completed the acceptance process for structural inspection or corrosion control. It therefore follows that the operator's aeroplane maintenance programme cannot be approved as a complete programme but it is reasonable to approve for a limited period, say, 3000 flight hours or 1 year;
 - 2.2 A new operator may not have established suitable maintenance arrangements for the high-life time checks. It therefore follows that the Authority may be unable to approve the complete operator's aeroplane maintenance programme, preferring to opt for a limited period.



3. If the Authority is no longer satisfied that a safe operation can be maintained, the approval of the operator's aeroplane maintenance programme or part of it may be suspended or revoked. Events giving rise to such action include:
 - 3.1 The operator suspending the operation of that aeroplane type for at least one year;
 - 3.2 Periodic review of the approved operator's aeroplane maintenance programme by the Authority shows that the operator has failed to ensure that the maintenance programme reflects the maintenance needs of the aeroplane such that safe operation can be assured.
 - 3.3 Excessive variations to the maintenance periods as defined in OPS 1.910(e) or where variations have been applied at times when the circumstances leading to the variations could have been reasonably foreseen by the operator.

AMC OPS 1.915

Operator's Aeroplane Technical Log

See OPS 1.915

1. The operator's aeroplane technical log is a system for recording defects and malfunctions discovered during the operation and for recording details of all maintenance carried out on the particular aeroplane to which the operator's aeroplane technical log applies whilst that aeroplane is operating between scheduled visits to the base maintenance facility. In addition, it is used for recording operating information relevant to flight safety and should contain maintenance data that the operating crew need to know. Where a means of recording defects or malfunctions in the cabin or galleys that affect the safe operation of the aeroplane or the safety of its occupants, separate from the aeroplane technical log, is used, this should be regarded as forming part of the aeroplane technical log system.
2. The operator's aeroplane technical log system may range from a simple single section document to a complex system containing many sections but in all cases it should include the information specified for the example used here which happens to use a 5 section document / computer system:

Section 1 should contain details of the registered name and address of the operator, the aeroplane type and the complete international registration marks of the aeroplane.

Section 2 should contain details of when the next scheduled maintenance is due, including, if relevant any out of phase component changes due before the next maintenance check. In addition this Section should contain the current Certificate of Release to Service, for the complete aeroplane, issued normally at the end of the last maintenance check.

Note: The flight crew does not need to receive such details if the next scheduled maintenance is controlled by other means acceptable to the Authority.

Section 3 should contain details of all information considered necessary to ensure continued flight safety. Such information includes that defined in CAR OPS 1.915.

Note 1: Where Section 3 is of the multi-sector 'part removable' type then such 'part removable' sections should contain all of the foregoing information where appropriate.

Note 2: Section 3 should be designed such that one copy of each page may remain on the aeroplane and one other copy may be retained on the ground until completion of the flight to which it relates. See also OPS 1.140 Information retained on the ground (Subpart B).

Note 3: Section 3 lay-out should be divided to show clearly what is required to be completed after flight and what is required to be completed in preparation for the next flight.

Section 4 should contain details of all deferred defects that affect or may affect the safe operation of the aeroplane and should therefore be known to the aeroplane commander. Each page of this section should be pre-printed with the operator's name and page serial number and make provision for recording the following:

- i. A cross-reference for each deferred defect such that the original defect can be identified in the particular Section 3 Sector Record Page.
- ii. The original date of occurrence of the defect deferred.



- iii. Brief details of the defect.
- iv. Details of the eventual rectification carried out and its Certificate of Release to Service or a clear cross-reference back to the document that contains details of the eventual rectification.

Section 5 should contain any necessary maintenance support information that the aeroplane commander needs to know. Such information would include data on how to contact maintenance engineering if problems arise whilst operating the routes etc. The aeroplane technical log system can be either a paper or computer system or any combination of both methods.

3. A technical log formatted and containing the information required by EASA Part M (M.A.306 and the associated AMC) is acceptable to the Authority.

AMC OPS 1.920

Continuing Airworthiness Records

See OPS 1.920

1. The operator should ensure that he always receives a complete CAR 145 Certificate of Release to Service and any associated work pack such that the required records can be retained. The system to keep the continuing airworthiness records should be described in the operator's maintenance management exposition.
2. When the operator arranges for the relevant maintenance or continuing airworthiness management organisation to retain copies of the continuing airworthiness records on his behalf, he will nevertheless continue to be responsible for the records under OPS 1.920(b) relating to the preservation of records. If he ceases to be the operator of the aeroplane, he also remains responsible for transferring the records to any other person who becomes the operator of the aeroplane. The maintenance management exposition should describe who is keeping the records and where they are kept.
3. Keeping continuing airworthiness records in a form acceptable to the Authority normally means in paper form or on a computer database or a combination of both methods. Records stored in optical disc form are also acceptable.
4. Paper systems should use robust material which can withstand normal handling and filing. The record should remain legible throughout the required retention period.
5. Computer systems should have at least one backup system which should be updated at least within 24 hours of any maintenance. Each terminal is required to contain programme safeguards against the ability of unauthorised personnel to alter the database.
6. Optical storage of continuing airworthiness records may be carried out at any time. The records should be as legible as the original record and remain so for the required retention period.
7. Information on times, dates, cycles etc. as required by OPS 1.920 hereafter referred to as 'summary continuing airworthiness records' are those records that give an overall picture on the state of maintenance of the aeroplane and any life-limited aeroplane component. The current status of all life-limited aeroplane components should indicate the component life limitation, total number of hours, accumulated cycles or calendar time and the number of hours/cycles/time remaining before the required retirement time of the component is reached.
8. The current status of airworthiness directives (AD) should identify the applicable airworthiness directives including revision or amendment numbers and the means of compliance. Where an airworthiness directive is generally applicable to the aeroplane or component type but is not applicable to the particular aeroplane or component, then this should be identified. The airworthiness directive status includes the date when the airworthiness directive was accomplished, and where the airworthiness directive is controlled by flight hours or flight cycles it should include the aeroplane or engine or component total flight hours or cycles, as appropriate. For repetitive airworthiness directives, only the last application should be recorded in the airworthiness directive status. The status should also specify which part of a multi-part directive has been accomplished and the method, where a choice is available in the AD.
9. Details of current modification and repairs means the substantiating data supporting compliance with the airworthiness requirements. This can be in the form of a Supplemental Type Certificate, Service Bulletin, Structural Repair Manual or similar approved document.
10. The substantiating data may include:



- a. Compliance programme;
- b. Master drawing or drawing list, production drawings, installation instructions;
- c. Engineering reports (static strength, fatigue, damage tolerance, fault analysis, etc.);
- d. Ground and flight test programme and results;
- e. Mass and balance change data;
- f. Maintenance and repair manual supplements;
- g. Maintenance programme changes and instructions for continuing airworthiness; and
- h. Aeroplane flight manual supplement.

Some gas turbine engines are assembled from modules and a true total time in service for a total engine is not kept. When owners and operators wish to take advantage of the modular design, then total time in service and continuing airworthiness records for each module is to be maintained. The continuing airworthiness records as specified are to be kept with the module and should show the modifications, repairs and compliance with any mandatory requirements pertaining to that module.

11. Continuing airworthiness records should be stored in a safe way with regard to fire, flood, theft and alteration.
12. Computer backup discs, tapes etc., should be stored in a different location from that containing the current working discs, tapes, etc. and in a safe environment.

AMC OPS 1.920(b)(6)
Continuing Airworthiness Records
See OPS 1.920(b)(6)

For the purpose of this paragraph, a “component vital to flight safety” means a component that includes Life Limited Parts or is subject to Airworthiness Limitations or a major component such as, undercarriage and flight controls.

AMC OPS 1.920(c)
Continuing Airworthiness Records
See OPS 1.920(c)

1. Where the operator terminates his operation, all retained continuing airworthiness records should be passed on to the new operator or, if there is no operator, stored as required by the Authority.
2. A “permanent transfer” does not generally include the dry lease-out of an aeroplane when the duration of the lease agreement is less than 6 months. However the Authority should be satisfied that all continuing airworthiness records necessary for the duration of the lease agreement are transferred to the lessee or made accessible to them. The Authority should be consulted in the case of a temporary change of operator.

AMC OPS 1.930
Continued validity of the Air Operator Certificate in Respect of the Maintenance System
See OPS 1.930

This paragraph covers scheduled changes to the maintenance system. Whilst the requirements relating to Air Operator Certificates, including their issue, variation and continued validity, are prescribed in Subpart C, this paragraph is included in Subpart M to ensure that operators remain aware that there is a requirement elsewhere which may affect continued acceptance of the maintenance arrangement.

AMC OPS 1.935
Equivalent Safety Case
See OPS 1.935

- 1 This paragraph is intended to provide the necessary flexibility to the Authority such that it may accept alternate means of compliance with any Subpart M requirement, particularly in the case of advancement of technology.



Appendix 1 to AMC OPS 1.905(a)

Maintenance Management Exposition Suggested Format and Required Contents

The exposition may be put together in any subject order so long as all applicable subjects are covered.

PART 0 GENERAL ORGANISATION

- 0.1 Corporate Commitment by the Operator
- 0.2 Description of the Organisation
 - Brief description of organisation
 - Relationship with other organisations
 - Facilities
- 0.3 Continuing Airworthiness Management Personnel
 - Accountable Manager
 - Nominated Post Holder for Continuing Airworthiness
 - Quality Manager
 - Quality Auditor
 - Duties and Responsibilities
 - o Accountable Manager
 - o Post Holder for Continuing Airworthiness
 - o Quality Manager
 - o Quality Auditor/Monitor
 - o (Other Key members of staff with responsibilities for compliance with Subpart M)
 - Organisation Chart – Continuing Airworthiness Management
 - Manpower Resources and the Training Policy
 - Manpower Resources
 - Training
 - Competence of Staff
- 0.4 Notification Procedure to the CAA Regarding Changes to the Operator's Maintenance Arrangements/Locations/Personnel/Activities/Approval Changes
- 0.5 Maintenance Management Exposition Amendment Procedures and MME Review

PART 1 CONTINUING AIRWORTHINESS AND MAINTENANCE PROCEDURES

- 1.0 CAR-OPS 1 Maintenance Procedures
- 1.1 Aircraft Technical Log Utilisation and MEL Application
 - The Aircraft Technical Log
 - The Technical Log Contents
 - MEL Application
 - MEL procedure.
 - Acceptance by Pilot
 - Management of the MEL Rectification Intervals (RI's)
 - MEL Rectification Interval expiry.
- 1.2 Aircraft Maintenance Programme
 - The Maintenance Programme
 - Structural Inspections and Corrosion Control
 - Mandatory Life Limitations
 - Inspection Standards
 - Maintenance Certification
 - Fuel Contamination
 - The Maintenance Programme Owner
 - The Holders of the Maintenance Programme
 - Maintenance Programme Review, Development and Amendment
 - Development and Amendment
 - Maintenance Programme Meetings
 - Maintenance Programme Amendments
 - Maintenance Programme Variations
 - Variations in Excess of that Allowed to be granted by the Operator
 - Effects of Modifications and Repairs on Maintenance Programme



- 1.3 Continued Airworthiness Records: Responsibilities, Retention and Access
 - Maintenance and Continuing Airworthiness Records
 - Maintenance and Continuing Airworthiness Record Control and Management
 - Monitoring of Maintenance Between Scheduled Maintenance
 - Sector Record Page Retention
 - Access to maintenance and continuing airworthiness records and their Preservation
 - Transfer of continuing airworthiness records in the Event of a Sale or Disposal of the Aircraft
 - Access to maintenance and continuing airworthiness records in the Event of an Accident/Incident
- 1.4 Accomplishment and Control of Airworthiness Directives
 - Airworthiness Directives – Access and Review
 - AD Implementation
 - AD Compliance Monitoring
 - Recording of AD Compliance
- 1.5 Analysis of the Effectiveness of the Maintenance Programme
 - Airworthiness Review Meetings
 - Frequency of Meetings
- 1.6 Non-Mandatory Modification Embodiment Policy
 - Modifications General
 - Service Bulletins
 - Other Modifications
 - Recording of Modifications
- 1.7 Defect Reports
 - Analysis
 - Liaison with Manufacturers and Regulatory Authorities
 - Deferred Defect Policy
 - Non Deferrable Defects Away from Base
 - Repetitive Defects
 - Mandatory Occurrence Reporting
 - Airworthiness Review Meetings
 - Reliability Data Sharing/Pooling
- 1.8 Engineering Activity
 - Modifications and Repairs
 - Approval of Modifications and Repair Data
- 1.9 Aircraft Reliability Programmes and Engine Health Monitoring
- 1.10 Pre-Flight Inspection
 - The Pre-flight Inspection
 - The Daily Check/Check A
 - Pilot Authorisation
 - Sub-contracted Ground Handling functions
 - Security of Cargo and Baggage loading
 - Control of Aircraft Refuelling, Quantity/Quality
 - Control of Snow, Ice, Dust and Sand Contamination to an Approved Standard
 - Certificate of Airworthiness Validity
- 1.11 Mass and Balance
- 1.12 Alternative Configurations
- 1.13 Check Flight Procedures
- 1.14 Leasing of Aircraft
- 1.15 Tools and Equipment for Pre-Flight Inspections
- 1.16 Flight Recorder Inspections
- 1.17 Control of Field Loadable software and Database Loadable Data



- 1.18 Airworthiness Review Procedure for 2 year C of A (if applicable)
- 1.19 Sample of Documents, Tags and Forms Used
- 1.20 Other Relevant Procedures

PART 2 QUALITY AND SAFETY MANAGEMENT SYSTEM

- 2.1 Maintenance Quality Policy, Plan and Audit Procedures
 - Maintenance and Continuing Airworthiness Quality Policy
 - Management Responsibility Towards Quality
 - Independence
 - Document Control Policy
 - Quality Programme
 - Quality Audit Procedure
 - Quality Audit Remedial Action Procedure
 - Safety Management System
- 2.2 Monitoring of Maintenance Management Activities
- 2.3 Monitoring the Effectiveness of the Maintenance Programme
- 2.4 Monitoring that all Maintenance is Carried Out by an Appropriately Approved CAR 145 Maintenance Organisation
- 2.5 Monitoring that all Contracted Maintenance is Carried out in accordance with the Contract, including Sub-contractors used by the Maintenance Contractor
- 2.6 Quality Audit Personnel

PART 3 CONTRACTED MAINTENANCE

- 3.0 Aircraft Operated
- 3.1 Contracted Maintenance
- 3.2 Maintenance Contractor Selection Procedure
- 3.3 Advising to the CAA of Changes to the Maintenance Support
- 3.4 Detailed List of Maintenance Contractors
- 3.5 Relevant Technical Procedures Identified in the Maintenance Contract(s)
- 3.6 Contracted Continuing Airworthiness Tasks
- 3.7 Continuing Airworthiness Sub-Contractor Selection Procedure
- 3.8 Advising the CAA of Changes to the Continuing Airworthiness Sub-Contractor
- 3.9 Detailed List of Organisations Sub-Contracted for Continuing Airworthiness Tasks
- 3.10 Relevant Technical Procedures Identified in the Contract(s)

PART 4 APPENDICES

- Appendix 1 – Example Sector Record Page
- Appendix 2 – Example Acceptable Deferred Defect Page
- Appendix 3 – Maintenance Contracts
- Appendix 4 – Continuing Airworthiness Sub-Contractor Contracts



Appendix 5 – Sample Forms and Tags

Appendix 6 – The Quality Audit Programme

Note: Copies of the maintenance contracts and continuing airworthiness sub-contractor contracts if not included in the MME as an appendix, then their location should be described so that they may be readily accessed.



Appendix 1 to AMC OPS 1.910(a), (b), (c) and (d)
Operator's Aeroplane Maintenance Programme
See OPS 1.910(a), (b), (c), and (d)

- 1.1 The maintenance programme should contain the following basic information.
- 1.1.1 The type/model and registration number of the aeroplane, engines and, where applicable, auxiliary power units and propellers.
- 1.1.2 The name and address of the operator.
- 1.1.3 The operator's reference identification of the maintenance programme document; the date of issue and issue number.
- 1.1.4 A statement signed by the operator to the effect that the specified aeroplanes will be maintained to the maintenance programme and that the maintenance programme will be reviewed and updated as required by paragraph 3.
- 1.1.5 Contents/list of effective pages of the document.
- 1.1.6 Check periods which reflect the anticipated utilisation of the aeroplane. Such utilisation should be stated and include a tolerance of not more than 25%. Where utilisation cannot be anticipated, calendar time limits should also be included.
- 1.1.7 Procedures for the escalation of established check periods, where applicable and acceptable to the Authority.
- 1.1.8 Provision to record date and reference to approved amendments incorporated in the maintenance programme.
- 1.1.9 Details of pre-flight maintenance tasks which are accomplished by maintenance staff and not included in the Operations Manual for action by flight crew.
- 1.1.10 The tasks and the periods (intervals/frequencies) at which each part of the aeroplane, engines, APU's, propellers, components, accessories, equipment, instruments, electrical and radio apparatus, and associated systems and installations should be inspected, together with the type and degree of inspection.
- 1.1.11 The periods at which items as appropriate, should be checked, cleaned, lubricated, replenished, adjusted and tested.
- 1.1.12 Details of applicable ageing aeroplane systems requirements together with any specified sampling programmes.
- 1.1.13 Details of specific structural maintenance programmes where issued by the Type Certificate holder including but not limited to:
- Maintenance of Structural Integrity by Damage Tolerance and Supplemental Structural Inspection Programmes (SSID)
 - Structural maintenance programmes resulting from the Service Bulletin review performed by the Type Certificate holder
 - Corrosion Prevention and Control
 - Repair Assessment
 - Widespread Fatigue Damage
- 1.1.14 A statement of the limit of validity (LOV) in terms of total flight cycles/calendar data/flight hours for the structural programme in 1.1.13.
- 1.1.15 The periods and procedures for the collection of engine health monitoring data.
- 1.1.16 The periods at which overhauls and/or replacements by new or overhauled parts should be made.



- 1.1.17 A cross-reference to other documents approved by the Authority which contain the details of maintenance tasks related to mandatory life limitations, Certification Maintenance Requirements (CMR's) and Airworthiness Directives (AD's).

Note: To prevent inadvertent variations to such tasks or intervals these items should not be included in the main portion of the maintenance programme document, or any planning control system, without specific identification of their mandatory status.

- 1.1.18 Details of, or cross-reference to, any required reliability programme or statistical methods of continuous surveillance.
- 1.1.19 A statement that practices and procedures to satisfy the programme should be to the standards specified in the Type Certificate holder's maintenance instructions. When practices and procedures are included in a customised operator's Maintenance Manual, the statement should refer to this manual.
- 1.1.20 Each maintenance task quoted should be defined in a definition section of the maintenance programme.

2. Programme basis

- 2.1 Operators' aeroplane maintenance programmes should normally be based upon the Maintenance Review Board Report (MRBR), where available, and the Type Certificate holder's Maintenance Planning Document (MPD) or Chapter 5 of the Maintenance Manual, (i.e. the manufacturer's recommended maintenance programme). The structure and format of these maintenance recommendations may be re-written by the operator to better suit his operation and control of the particular maintenance programme.
- 2.2 For a newly type-certificated aeroplane, where no previously approved maintenance programme exists, it will be necessary for the operator to comprehensively appraise the manufacturer's recommendations (and the MRB Report where applicable), together with other airworthiness information, in order to produce a realistic maintenance programme for approval.
- 2.3 For existing aeroplane types it is permissible for the operator to make comparisons with maintenance programmes previously approved. It should not be assumed that a maintenance programme approved for another operator will automatically be approved for the operator. Evaluation is to be made of aircraft/fleet utilisation, landing rate, equipment fit and, in particular, the experience of the maintenance organisation must be assessed. Where the Authority is not satisfied that the proposed maintenance programme can be used as is by the operator, the Authority should request the operator to introduce appropriate changes to it, such as additional maintenance tasks or de-escalation of check frequencies, or to develop the aeroplane initial maintenance programme based upon the manufacturer's recommendations.

3. Amendments

- 3.1 Amendments (revisions) to the approved maintenance programme should be raised by the operator, to reflect changes in the type certificate holder's recommendations, modifications, service experience, or as required by the Authority. Reliability programmes form one important method of updating approved programmes.

4. Permitted variations to maintenance periods

- 4.1 The operator may only vary the periods prescribed by the maintenance programme with the approval of the Authority.



This Page Intentionally Left Blank



AC/AMC N

FLIGHT CREW

AMC OPS 1.940(a)(4)

Crewing of Inexperienced Flight Crew Members

See OPS 1.940(a)(4)

1. The operator should consider that a flight crew member is inexperienced, following completion of a Type Rating or command course, and the associated line flying under supervision, until he has achieved on the Type either:
 - a. 100 flying hours and flown 10 sectors within a consolidation period of 120 consecutive days; or
 - b. 150 flying hours and flown 20 sectors (no time limit).
2. A lesser number of flying hours or sectors, subject to any other conditions which the Authority may impose, may be acceptable to the Authority when:
 - a. A new operator is commencing operations; or
 - b. The operator introduces a new aeroplane type; or
 - c. Flight crew members have previously completed a type conversion course with the same operator; or
 - d. The aeroplane has a Maximum Take-off Mass below 10 tonnes or a Maximum Approved Passenger Seating Configuration of less than 20.

AMC OPS 1.945

Conversion Course Syllabus

See OPS 1.945 and Appendix 1 to OPS 1.945

1. General
 - 1.1 Type rating training when required may be conducted separately or as part of conversion training. When the type rating training is conducted as part of conversion training, the conversion training programme should include all the requirements of the licensing regulations.
2. Ground training
 - 2.1 Ground training should comprise a properly organised programme of ground instruction by training staff with adequate facilities, including any necessary audio, mechanical and visual aids. However, if the aeroplane concerned is relatively simple, private study may be adequate if the operator provides suitable manuals and/or study notes.
 - 2.2 The course of ground instruction should incorporate formal tests on such matters as aeroplane systems, performance and flight planning, where applicable.
3. Emergency and safety equipment training and checking
 - 3.1 On the initial conversion course and on subsequent conversion courses as applicable, the following should be addressed:
 - a. Instruction on first aid in general (Initial conversion course only); Instruction on first aid as relevant to the aeroplane type of operation and crew complement including where no cabin crew are required to be carried (Initial and subsequent);
 - b. Aeromedical topics including:
 - i. Hypoxia;
 - ii. Hyperventilation;
 - iii. Contamination of the skin/eyes by aviation fuel or hydraulic or other fluids;
 - iv. Hygiene and food poisoning; and
 - v. Malaria;



- c. The effect of smoke in an enclosed area and actual use of all relevant equipment in a simulated smoke-filled environment;
 - d. The operational procedures of security, rescue and emergency services.
 - e. Survival information appropriate to their areas of operation (e.g. polar, desert, jungle or sea) and training in the use of any survival equipment required to be carried.
 - f. A comprehensive drill to cover all ditching procedures should be practised where flotation equipment is carried. This should include practice of the actual donning and inflation of a lifejacket, together with a demonstration or film of the inflation of life-rafts and/or slide-rafts and associated equipment. This practice should, on an initial conversion course, be conducted using the equipment in water, although previous certificated training with another operator or the use of similar equipment will be accepted in lieu of further wet-drill training.
 - g. Instruction on the location of emergency and safety equipment, correct use of all appropriate drills, and procedures that could be required of flight crew in different emergency situations. Evacuation of the aeroplane (or a representative training device) by use of a slide where fitted should be included when the Operations Manual procedure requires the early evacuation of flight crew to assist on the ground.
4. Aeroplane/FSTD training
 - 4.1 Flying training should be structured and sufficiently comprehensive to familiarise the flight crew member thoroughly with all aspects of limitations and normal /abnormal and emergency procedures associated with the aeroplane and should be carried out by suitably qualified Type Rating Instructors and/or Type Rating Examiners. For specialised operations such as steep approaches, EDTO, All Weather Operations or QFE operations, additional training should be carried out.
 - 4.2 In planning aeroplane/FSTD training on aeroplanes with a flight crew of two or more, particular emphasis should be placed on the practice of Line Orientated Flying Training (LOFT) with emphasis on Crew Resource Management (CRM).
 - 4.3 Normally, the same training and practice in the flying of the aeroplane should be given to co-pilots as well as commanders. The 'flight handling' sections of the syllabus for commanders and co-pilots alike should include all the requirements of the operator proficiency check required by OPS 1.965.
 - 4.4 Unless the type rating training programme has been carried out in a Flight Simulator usable for zero flight-time (ZFT) conversion, the training should include at least 3 take-offs and landings in the aeroplane.
 5. Line flying under supervision
 - 5.1 Following completion of aeroplane/FSTD training and checking as part of the operator's conversion course, each flight crew member should operate a minimum number of sectors and/or flying hours under the supervision of a flight crew member nominated by the operator and acceptable to the Authority.
 - 5.2 The minimum sectors/hours should be specified in the Operations Manual and should be determined by the following:
 - a. Previous experience of the flight crew member;
 - b. Complexity of the aeroplane; and
 - c. The type and area of operation.
 - 5.3 A line check in accordance with OPS 1.945(a)(8) should be completed upon completion of line flying under supervision.
 6. System Panel Operator
 - 6.1 Conversion training for system panel operators should approximate to that of pilots.
 - 6.2 If the flight crew includes a pilot with duties of a systems panel operator, he should, after training and the initial check in these duties, operate a minimum number of sectors under the supervision of a nominated additional flight crew member. The minimum figures should be specified in the Operations Manual and should be selected after due note has been taken of the complexity of the aeroplane and the experience of the flight crew member.

**AMC OPS 1.945****Line Flying under Supervision****See OPS 1.945**

1. Introduction
- 1.1 Line flying under supervision provides the opportunity for a flight crew member to carry into practice the procedures and techniques he has been made familiar with during the ground and flying training of a conversion course. This is accomplished under the supervision of a flight crew member specifically nominated and trained for the task. At the end of line flying under supervision the respective crew member should be able to perform a safe and efficient flight conducted within the tasks of his crew member station.
- 1.2 The following minimum figures for details to be flown under supervision are guidelines for operators to use when establishing their individual requirements.
2. Turbo jet aircraft
 - a. Co-pilot undertaking first conversion course:
 - i. Total accumulated 100 hours or minimum 40 sectors;
 - b. Co-pilot upgrading to commander:
 - i. Minimum 20 sectors when converting to a new type;
 - ii. Minimum 10 sectors when already qualified on the aeroplane type.

AC OPS (AMC) 1.943/1.945(a)(9)/1.955(b)(6)/1.965(e)**Crew Resource Management (CRM)****See OPS 1.943/1.945(a)(9)/1.955(b)(6)/1.965(e)/1.965(a)(3)(iv)****See AC OPS (AMC) 1.943/1.945(a)(9)/1.955(b)(6)/1.965(e)**

1. General
 - 1.1 Crew Resource Management (CRM) is the effective utilisation of all available resources (e.g. crew members, aeroplane systems, supporting facilities and persons) to achieve safe and efficient operation.
 - 1.2 The objective of CRM is to enhance the communication and management skills of the flight crew member concerned. The emphasis is placed on the non-technical aspects of flight crew performance.
2. Initial CRM Training
 - 2.1 Initial CRM training programmes are designed to provide knowledge of, and familiarity with, human factors relevant to flight operations. The course duration should be a minimum of one day for single-pilot operations and two days for all other types of operations. It should cover all elements in Table 1, column (a) to the level required by column (b) (Initial CRM training).
 - 2.2 CRM Trainer
 - a. A CRM trainer should possess group facilitation skills and should at least:
 - i. Have current commercial air transport experience as a flight crew member; and have either:
 - (A) Successfully passed the Human Performance and Limitations (HPL) examination whilst recently obtaining the ATPL (see the requirements applicable to the issue of Flight Crew Licences); or,
 - (B) If holding a Flight Crew Licence acceptable under OPS 1.940(a)(3) prior to the introduction of HPL into the ATPL syllabus, followed a theoretical HPL course covering the whole syllabus of the HPL examination.
 - ii. Have completed initial CRM training; and
 - iii. Be supervised by suitably qualified CRM training personnel when conducting their first initial CRM training session; and
 - iv. Have received additional education in the fields of group management, group dynamics and personal awareness.
 - b. Notwithstanding paragraph (a) above, and when acceptable to the Authority;



- i. A flight crew member holding a recent qualification as a CRM trainer may continue to be a CRM trainer even after the cessation of active flying duties;
 - ii. An experienced non-flight crew CRM trainer having a knowledge of HPL, may also continue to be a CRM trainer;
 - iii. A former flight crew member having knowledge of HPL may become a CRM trainer if he maintains adequate knowledge of the operation and aeroplane type and meets the provisions of paragraphs 2.2a ii, iii and iv.
- 2.3 The operator should ensure that initial CRM training addresses the nature of the operations of the company concerned, as well as the associated procedures and the culture of the company. This will include areas of operations which produce particular difficulties or involve adverse climatic conditions and any unusual hazards.
- 2.4 If the operator does not have sufficient means to establish initial CRM training, use may be made of a course provided by another operator, or a third party or training organisation acceptable to the Authority. In this event the operator should ensure that the content of the course meets his operational requirements. When crew members from several companies follow the same course, CRM core elements should be specific to the nature of operations of the companies and the trainees concerned.
- 2.5 A flight crew member's CRM skills should not be assessed during initial CRM training.
3. Conversion Course CRM training
 - 3.1 If the flight crew member undergoes a conversion course with a change of aeroplane type, all elements in Table 1, column (a) should be integrated into all appropriate phases of the operator's conversion course and covered to the level required by column (c) (conversion course when changing type).
 - 3.2 If the flight crew member undergoes a conversion course with a change of operator, all elements in Table 1, column (a) should be integrated into all appropriate phases of the operator's conversion course and covered to the level required by column (d) (conversion course when changing operator) unless the two operators use the same CRM training provider.
 - 3.3 A flight crew member should not be assessed when completing elements of CRM training which are part of the operator's conversion course.
4. Command course CRM training
 - 4.1 The operator should ensure that all elements in Table 1, column (a) are integrated into the command course and covered to the level required by column (e) (command course).
 - 4.2 A flight crew member should not be assessed when completing elements of CRM training which are part of the command course, although feedback should be given.
5. Recurrent CRM training
 - 5.1 The operator should ensure that :
 - a. Elements of CRM are integrated into all appropriate phases of recurrent training every year; and that all elements in Table 1, column (a) are covered to the level required by column (f) (recurrent training); and that modular CRM training covers the same areas over a maximum period of 3 years.
 - b. Relevant modular CRM training is conducted by CRM trainers qualified according to paragraph 2.2.
 - 5.2 A flight crew member should not be assessed when completing elements of CRM training which are part of recurrent training.
6. Implementation of CRM
 - 6.1 The following table indicates which elements of CRM should be included in each type of training:



Table 1

Core Elements (a)	Initial CRM Training (b)	Operator's conversion course when changing type (c)	Operator's conversion course when changing operator (d)	Command course (e)	Recurrent training (f)
Human error and reliability, error chain, error prevention and detection	In depth	In depth	Overview	Overview	Overview
Company safety culture, SOPs, organisational factors		Not required	In depth	In-depth	
Stress, stress management, fatigue & vigilance			Not required		
Information acquisition and processing situation awareness, workload management		Overview	Overview	Overview	
Decision making					
Communication and co-ordination inside and outside the cockpit					
Leadership and team behaviour synergy		As required	In depth	In depth	
Automation, philosophy of the use of automation (if relevant to the type)	Not required				
Specific type-related differences					
Case based studies	In depth	In depth	In depth	In depth	As appropriate

- 7. Co-ordination between flight crew and cabin crew training
- 7.1 Operators should, as far as is practicable, provide combined training for flight crew and cabin crew including briefing and debriefing.
- 7.2 There should be an effective liaison between flight crew and cabin crew training departments. Provision should be made for flight and cabin crew instructors to observe and comment on each other's training.
- 8. Assessment of CRM Skills (See AC OPS (AMC) 1.943/1.945(a)(9)/1.955(b)(6)/1.965(e), paragraph 4)
- 8.1 Assessment of CRM skills should:
 - a. Provide feedback to the individual and serve to identify retraining where needed; and
 - b. Be used to improve the CRM training system.
- 8.2 Prior to the introduction of CRM skills assessment, a detailed description of the CRM methodology including terminology used, acceptable to the Authority, should be published in the Operations Manual.
- 8.3 Operators should establish procedures including retraining, to be applied in the event that personnel do not achieve or maintain the required standards (Appendix 1 to 1.1045, Section D, paragraph 3.2 refers).
- 8.4 If the operator proficiency check is combined with the Type Rating revalidation/renewal check, the assessment of CRM skills will satisfy the Multi Crew Co-operation requirements of the Type Rating revalidation/renewal. This assessment will not affect the validity of the Type Rating.



AC OPS (AMC) 1.943/1.945(a)(9)/1.955(b)(6)/1.965(e)
Crew Resource Management (CRM)
See OPS 1.943/1.945(a)(9)/1.955(b)(6)/1.965(e)
See AMC OPS 1.943/1.945(a)(9)/1.955(b)(6)/1.965(e)

1. CRM training should reflect the culture of the operator and be conducted by means of both classroom training and practical exercises including group discussions and accident and serious incident reviews to analyse communication problems and instances or examples of a lack of information or crew management.
2. Whenever it is practicable to do so, consideration should be given to conducting relevant parts of CRM training in synthetic training devices which reproduce, in an acceptable way, a realistic operational environment and permit interaction. This includes, but is not limited to, simulators with appropriate LOFT scenarios.
3. It is recommended that, whenever possible, initial CRM training be conducted in a group session outside the company premises so that the opportunity is provided for flight crew members to interact and communicate away from the pressures of their usual working environment.
4. **Assessment of CRM Skills**
 - 4.1 Assessment of CRM skills is the process of observing, recording, interpreting and debriefing crews' and crew member's performance and knowledge using an acceptable methodology in the context of overall performance. It includes the concept of self-critique, and feedback which can be given continuously during training or in summary following a check. In order to enhance the effectiveness of the programme this methodology should, where possible, be agreed with flight crew representatives.
 - 4.2 NOTECHS or other acceptable methods of CRM skills assessment should be used. The selection criteria and training requirements of the assessors and their relevant qualifications, knowledge and skills should be established.
 - 4.3 Methodology of CRM skills assessment:
 - a. The operator should establish the CRM training programme including an agreed terminology. This should be evaluated with regard to methods, length of training, depth of subjects and effectiveness.
 - b. A training and standardisation programme for training personnel should then be established.
 - c. The assessment should be based on the following principles:
 - i. only observable, repetitive behaviours are assessed,
 - ii. the assessment should positively reflect any CRM skills that result in enhanced safety,
 - iii. assessments should include behaviour which contributes to a technical failure, such technical failure being errors leading to an event which requires debriefing by the person conducting the line check,
 - iv. the crew and, where needed, the individual are orally debriefed.
 - 4.4 De-identified summaries of all CRM assessments by the operator should be used to provide feedback to update and improve the operator's CRM training.
5. **Levels of Training.**
 - a. **Overview.** When Overview training is required it will normally be instructional in style. Such training should refresh knowledge gained in earlier training.
 - b. **In Depth.** When In Depth Training is required it will normally be interactive in style and should include, as appropriate, case studies, group discussions, role play and consolidation of knowledge and skills. Core elements should be tailored to the specific needs of the training phase being undertaken.

**AMC OPS 1.945(a)(9)****Crew Resource Management - Use of Automation****See OPS 1.945(a)(9)**

1. The conversion course should include training in the use and knowledge of automation and in the recognition of systems and human limitations associated with the use of automation. The operator should therefore ensure that a flight crew member receives training on:
 - a. The application of the operations policy concerning the use of automation as stated in the Operations Manual; and
 - b. System and human limitations associated with the use of automation.
2. The objective of this training should be to provide appropriate knowledge, skills and behavioural patterns for managing and operating automated systems. Special attention should be given to how automation increases the need for crews to have a common understanding of the way in which the system performs, and any features of automation which make this understanding difficult.

AMC OPS 1.965(c)**Line checks****See OPS 1.965(c)**

1. Where a pilot is required to operate as pilot flying and pilot monitoring, he should be checked on one sector as pilot flying and on another sector as pilot monitoring.
2. However, where the operator's procedures require integrated flight preparation, integrated flight crew compartment initialisation and that each pilot performs both flying and monitoring duties on the same sector, then the line check may be performed on a single sector.

AMC OPS 1.965(d)**Emergency and Safety Equipment Training****See OPS 1.965(d)**

1. The successful resolution of aeroplane emergencies requires interaction between flight crew and cabin crew and emphasis should be placed on the importance of effective co-ordination and two-way communication between all crew members in various emergency situations.
2. Emergency and Safety Equipment training should include joint practice in aeroplane evacuations so that all who are involved are aware of the duties other crew members should perform. When such practice is not possible, combined flight crew and cabin crew training should include joint discussion of emergency scenarios.
3. Emergency and safety equipment training should, as far as is practicable, take place in conjunction with cabin crew undergoing similar training with emphasis on co-ordinated procedures and two-way communication between the flight deck and the cabin.

AMC OPS 1.965**Recurrent Training and Checking****See OPS 1.965**

1. Line checks, route and aerodrome competency and recent experience requirements are intended to ensure the crew member's ability to operate efficiently under normal conditions, whereas other checks and emergency and safety equipment training are primarily intended to prepare the crew member for abnormal/emergency procedures.
2. The line check is performed in the aeroplane. All other training and checking should be performed in the aeroplane of the same type or a FSTD or, an approved flight simulator or, in the case of emergency and safety equipment training, in a representative training device. The type of equipment used for training and checking should be representative of the instrumentation, equipment and layout of the aeroplane type operated by the flight crew member.



3. Line Checks
 - 3.1 The line check is considered a particularly important factor in the development, maintenance and refinement of high operating standards, and can provide the operator with a valuable indication of the usefulness of his training policy and methods. Line checks are a test of a flight crew member's ability to perform a complete line operation satisfactorily, including pre-flight and post flight procedures and use of the equipment provided, and an opportunity for an overall assessment of his ability to perform the duties required as specified in the Operations Manual. The route chosen should be such as to give adequate representation of the scope of a pilot's normal operations. When weather conditions preclude a manual landing, an automatic landing is acceptable. The line check is not intended to determine competence on any particular route. The commander, or any pilot who may be required to relieve the commander, should also demonstrate his ability to 'manage' the operation and take appropriate command decisions.
4. Proficiency Training and Checking
 - 4.1 When a FSTD is used, the opportunity should be taken, where possible, to use Line Oriented Flying Training (LOFT).
 - 4.2 Proficiency training and checking for System Panel Operators should, where practicable, take place at the same time a pilot is undergoing proficiency training and checking.

AMC to Appendix 1 to OPS 1.965**Pilot Incapacitation Training****See Appendix 1 to OPS 1.965, paragraph (a)(1)**

1. Procedures should be established to train flight crew to recognise and handle pilot incapacitation. This training should be conducted every year and can form part of other recurrent training. It should take the form of classroom instruction, discussion or video or other similar means.
2. If a Flight Simulator is available for the type of aeroplane operated, practical training on pilot incapacitation should be carried out at intervals not exceeding 3 years.

AMC OPS 1.970**Recency****See OPS 1.970**

When using a Flight Simulator for meeting the landing requirements in OPS 1.970(a)(1) and (a)(2), complete visual traffic patterns or complete IFR procedures starting from the Initial Approach Fix should be flown.

AMC OPS 1.970(a)(2)**Co-pilot Proficiency****See OPS 1.970(a)(2)**

A co-pilot serving at the controls means that that pilot is either pilot flying or pilot monitoring. The only required take-off and landing proficiency for a co-pilot is the operator's and type-rating proficiency checks.

AMC OPS 1.975**Route and Aerodrome Competence Qualification****See OPS 1.975**

1. Route competence
 - 1.1 Depending on the complexity of the route, as assessed by the operator, the following methods of familiarisation should be used:
 - a. For the less complex routes, familiarisation by self-briefing with route documentation, or by means of programmed instruction; and
 - b. For the more complex routes, in addition to sub-paragraph 1.2.a above, in-flight familiarisation as a commander, co-pilot or observers under supervision, or familiarisation in a Synthetic Training Device using a database appropriate to the route concerned.



2. Aerodrome competence
 - 2.1 The Operations Manual should specify a method of categorisation of aerodromes and specify the requirements necessary for each of these categories. If the least demanding aerodromes are Category A, Category B and C would be applied to progressively more demanding aerodromes. The Operations Manual should specify the parameters which qualify an aerodrome to be considered Category A and then provide a list of those aerodrome categorised as B or C.
 - 2.2 All aerodromes to which the operator operates should be categorised in one of these three categories. The operator's categorisation should be acceptable to the Authority.
3. Category A. An aerodrome which satisfies all of the following requirements:
 - a. An approved instrument approach procedure;
 - b. At least one runway with no performance limited procedure for take-off and/or landing;
 - c. Published circling minima not higher than 1000 feet above aerodrome level; and
 - d. Night operations capability.
4. Category B. An aerodrome which does not satisfy the Category A requirements or which requires extra considerations such as:
 - a. Non-standard approach aids and/or approach patterns; or
 - b. Unusual local weather conditions; or
 - c. Unusual characteristics or performance limitations; or
 - d. Any other relevant considerations including obstructions, physical layout, lighting etc.
- 4.1 Prior to operating to a Category B aerodrome, the commander should be briefed, or self-briefed by means of programmed instruction, on the Category B aerodrome(s) concerned and should certify that he has carried out these instructions.
5. Category C. An aerodrome, which requires additional considerations to a Category B aerodrome.
 - 5.1 Prior to operating to a Category C aerodrome, the commander should be briefed and visit the aerodrome as an observer and/or undertake instruction in a Flight Simulator. This instruction should be certified by the operator.

AC OPS 1.978

Terminology

See OPS 1.978 and Appendix 1 to OPS 1.978

1. Terminology
 - 1.1 Line Oriented Evaluation (LOE). LOE is an evaluation methodology used in the ATQP to evaluate trainee performance, and to validate trainee proficiency. LOEs consist of flight simulator scenarios that are developed by the operator in accordance with a methodology approved as part of the ATQP. The LOE should be realistic and include appropriate weather scenarios and in addition should fall within an acceptable range of difficulty. The LOE should include the use of validated event sets to provide the basis for event based assessment. See paragraph 1.4 below.
 - 1.2 Line Oriented Quality Evaluation (LOQE). LOQE is one of the tools used to help evaluate the overall performance of an operation. LOQEs consist of line flights that are observed by appropriately qualified operator personnel to provide feedback to validate the ATQP. The LOQE should be designed to look at those elements of the operation that are unable to be monitored by FDM or Advanced FDM programmes.
 - 1.3 Skill-based training. Skill-based training requires the identification of specific knowledge and skills. The required knowledge and skills are identified within an ATQP as part of a task analysis and are used to provide targeted training.
 - 1.4 Event-based Assessment. This is the assessment of flight crew to provide assurance that the required knowledge and skills have been acquired. This is achieved within an LOE. Feedback to the flight crew is an integral part of event-based assessment.



AC to Appendix 1 to OPS 1.978(b)(1)
Requirements, Scope and Documentation of the Programme
See Appendix 1 to OPS 1.978(b)(1)

1. The documentation should demonstrate how the operator should establish the scope and requirements of the programme. The documentation should include:
 - 1.1 How the ATQP should enable the operator to establish an alternative training programme that substitutes the requirements as listed in OPS 1 E and N. The programme should demonstrate that the operator is able to improve the training and qualification standards of flight crew to a level that exceeds the standard prescribed in OPS 1.
 - 1.2 The operator's training needs and established operational and training objectives.
 - 1.3 How the operator defines the process for designing of and gaining approval for the operator's flight crew qualification programmes. This should include quantified operational and training objectives identified by the operator's internal monitoring programmes. External sources may also be used.
 - 1.4 How the programme will:
 - a. Enhance safety;
 - b. Improve training and qualification standards of flight crew;
 - c. Establish attainable training objectives;
 - d. Integrate CRM in all aspects of training;
 - e. Develop a support and feedback process to form a self-correcting training system;
 - f. Institute a system of progressive evaluations of all training to enable consistent and uniform monitoring of the training undertaken by flight crew;
 - g. Enable the operator to be able to respond to the new aeroplane technologies and changes in the operational environment;
 - h. Foster the use of innovative training methods and technology for flight crew instruction and the evaluation of training systems;
 - i. Make efficient use of training resources, specifically to match the use of training media to the training needs.

AC to Appendix 1 to OPS 1.978(b)(2)
Task Analysis
See Appendix 1 to OPS 1.978(b)(2)

1. For each aeroplane type/class to be included within the ATQP the operator should establish a systematic review that determines and defines the various tasks to be undertaken by the flight crew when operating that type(s)/class. Data from other types/class may also be used. The analysis should determine and describe the knowledge and skills required to complete the various tasks specific to the aeroplane type/class and/or type of operation. In addition the analysis should identify the appropriate behavioural markers that should be exhibited. The task analysis should be suitably validated in accordance with Appendix 1 to OPS 1.978(c)(iii). The task analysis, in conjunction with the data gathering programme(s) permit the operator to establish a programme of targeted training together with the associated training objectives described in AC to Appendix 1 to OPS 1.978(b)(3) paragraph (c) below.

AC to Appendix 1 to OPS 1.978(b)(3)
Training Programme
See Appendix 1 to OPS 1.978(b)(3)

1. The training programme should have the following structure:



- 1.1 Curriculum.
- 1.2 Daily lesson plan.
2. The curriculum should specify the following elements:
 - 2.1 Entry requirements: A list of topics and content, describing what training level will be required before start or continuation of training.
 - 2.2 Topics: A description of what will be trained during the lesson;
 - 2.3 Targets/Objectives
 - a. Specific target or set of targets that have to be reached and fulfilled before the training course can be continued.
 - b. Each specified target should have an associated objective that is identifiable both by the flight crew and the trainers.
 - c. Each qualification event that is required by the programme should specify the training that is required to be undertaken and the required standard to be achieved. (See paragraph 1.4 below)
3. Each lesson/course/training or qualification event should have the same basic structure. The topics related to the lesson have to be listed and the lesson targets should be unambiguous.
4. Each lesson/course or training event whether classroom, CBT or simulator should specify the required topics with the relevant targets to be achieved.

AC to Appendix 1 to OPS 1.978(b)(4)

Training Personnel

See Appendix 1 to OPS 1.978(b)(4)

1. Personnel who perform training and checking of flight crew in the operator's ATQP should receive the following additional training on:
 - 1.1 ATQP principles and goals;
 - 1.2 Knowledge/skills/behaviour as learned from task analysis;
 - 1.3 LOE/ LOFT Scenarios to include triggers / markers / event sets / observable behaviour;
 - 1.4 Qualification standards;
 - 1.5 Harmonisation of assessment standards;
 - 1.6 Behavioural markers and the systemic assessment of CRM;
 - 1.7 Event sets and the corresponding desired knowledge/skills and behaviour of the flight crew;
 - 1.8 The processes that the operator has implemented to validate the training and qualification standards and the instructors part in the ATQP quality control; and
 - 1.9 LOQE.

AC to Appendix 1 to OPS 1.978(b)(5)

Feedback Loop

See Appendix 1 to OPS 1.978(b)(5)

1. The feedback should be used as a tool to validate that the curricula are implemented as specified by the ATQP; this enables substantiation of the curriculum, and that proficiency and training objectives have been met. The feedback loop should include data from operations flight data monitoring, advanced FDM programme and LOE/LOQE programmes. In addition the evaluation process shall describe whether the overall targets/objectives of training are being achieved and shall prescribe any corrective action that needs to be undertaken.



- 2. The programmes established quality control mechanisms should at least review the following:
 - 2.1 Procedures for approval of recurrent training;
 - 2.2 ATQP instructor training approvals;
 - 2.3 Approval of event set(s) for LOE/LOFT;
 - 2.4 Procedures for conducting LOE and LOQE.

**AC to Appendix 1 to OPS 1.978(b)(6)
Crew Performance Measurement and Evaluation
See Appendix 1 to OPS 1.978(b)(6)**

- 1. The qualification and checking programmes should include at least the following elements:
 - 1.1 A specified structure;
 - 1.2 Elements to be tested/examined;
 - 1.3 Targets and/or standards to be attained;
 - 1.4 The specified technical and procedural knowledge and skills, and behavioural markers to be exhibited.
- 2. An LOE event should comprise of tasks and sub-tasks performed by the crew under a specified set of conditions. Each event has one or more specific training targets/objectives, which require the performance of a specific manoeuvre, the application of procedures, or the opportunity to practise cognitive, communication or other complex skills. For each event the proficiency that is required to be achieved should be established. Each event should include a range of circumstances under which the crews' performance is to be measured and evaluated. The conditions pertaining to each event should also be established and they may include the prevailing meteorological conditions (ceiling, visibility, wind, turbulence etc.); the operational environment (navigation aid inoperable etc.); and the operational contingencies (non-normal operation etc.).
- 3. The markers specified under the operator's ATQP should form one of the core elements in determining the required qualification standard. A typical set of markers are shown in the table below:

EVENT	MARKER
Awareness	1 Monitors and reports changes in automation status.
of Aeroplane Systems:	2 Applies closed loop principle in all relevant situations.
	3 Uses all channels for updates.
	4 Is aware of remaining technical resources.

- 4. The topics / targets integrated into the curriculum have to be measurable and progression on any training/course is only allowed if the targets are fulfilled.

**AC to Appendix 1 to OPS 1.978(b)(9)
Data Monitoring/Analysis Programme
See Appendix 1 to OPS 1.978(b)(9)**

- 1. The data analysis programme should consist of:
 - 1.1 A Flight Data Monitoring (FDM) programme: This programme should include systematic evaluation of operational data derived from equipment that is able to record the flight profile and relevant operational information during flights conducted by the operator's aeroplane. Data collection should reach a minimum of 60% of all relevant flights conducted by the operator before ATQP approval is granted. This proportion may be increased at the discretion of the Authority.



- 1.2 An Advanced FDM when an extension to the ATQP is requested: An advanced FDM programme is determined by the level of integration with other safety initiatives implemented by the operator, such as the operator's Quality System. The programme should include both systematic evaluations of data from an FDM programme and flight crew training events for the relevant crews. Data collection should reach a minimum of 80% of all relevant flights and training conducted by the operator. This proportion may be varied at the discretion of the Authority.
2. The purpose of either an FDM or advanced FDM programme is to enable the operator to:
 - 2.1 Provide data to support the programme's implementation and justify any changes to the ATQP;
 - 2.2 Establish operational and training objectives based upon an analysis of the operational environment;
 - 2.3 Monitor the effectiveness of flight crew training and qualification.
3. Data Gathering.
 - 3.1 FDM programmes should include a system that captures flight data, and then transforms the data into an appropriate format for analysis. The programme should generate information to assist the operations safety personnel in analysing the data. The analysis should be made available to the ATQP postholder.
 - 3.2 The data gathered should:
 - a. Include all fleets that plan to operate under the ATQP;
 - b. Include all crews trained and qualified under the ATQP;
 - c. Be established during the implementation phase of ATQP; and
 - d. Continue throughout the life of the ATQP.
4. Data Handling.
 - 4.1 The operator should establish a process, which ensures the strict adherence to any data handling protocols, agreed with flight crew representative bodies, to ensure the confidentiality of individual flight crew members.
 - 4.2 The data handling protocol should define the maximum period of time that detailed FDM or advanced FDM programme data, including exceedances, should be retained. Trend data may be retained permanently.
5. The operator that has an acceptable operations flight data monitoring programme prior to the proposed introduction of ATQP may, with the approval of the Authority, use relevant data from other fleets not part of the proposed ATQP.

AC to Appendix 1 to OPS 1.978(c)(1)(i)
Safety Case
See Appendix 1 to OPS 1.978(c)(1)(i)

1. Safety Case
 - 1.1 A documented body of evidence that provides a demonstrable and valid justification that the programme (ATQP) is adequately safe for the given type of operation. The safety case should encompass each phase of implementation of the programme and be applicable over the lifetime of the programme that is to be overseen.
 - 1.2 The safety case should:
 - a. Demonstrate the required level of safety;
 - b. Ensure the required safety is maintained throughout the lifetime of the programme;
 - c. Minimise risk during all phases of the programmes implementation and operation.
2. Elements of a Safety Case:



- 2.1 Planning: Integrated and planned with the operation (ATQP) that is to be justified;
 - 2.2 Criteria: Develop the applicable criteria - see paragraph 3 below;
 - 2.3 Documentation: Safety-related documentation – including a safety checklist;
 - 2.4 Programme of implementation: To include controls and validity checks;
 - 2.5 Oversight: Review and audits.
3. Criteria for the establishment of a Safety Case.
 - 3.1 The Safety Case should:
 - a. Be able to demonstrate that the required or equivalent level of safety is maintained throughout all phases of the programme, including as required by paragraph (c) below;
 - b. Be valid to the application and the proposed operation (ATQP);
 - c. Be adequately safe and ensure the required regulatory safety standards or approved equivalent safety standards are achieved;
 - d. Be applicable over the entire lifetime of the programme;
 - e. Demonstrate Completeness and Credibility of the programme;
 - f. Be fully documented;
 - g. Ensure integrity of the operation and the maintenance of the operations and training infra-structure;
 - h. Ensure robustness to system change;
 - i. Address the impact of technological advance, obsolescence and change;
 - j. Address the impact of regulatory change.
 4. In accordance with Appendix 1 to OPS 1.978 paragraph (c) the operator may develop an equivalent method other than that specified above.

AMC OPS 1.980**Operation on More than One Type or Variant****See OPS 1.980**

1. Terminology
 - 1.1 The terms used in the context of the requirement for operation of more than one type or variant have the following meaning:
 - a. Base aeroplane. An aeroplane, or a group of aeroplanes, designated by the operator and used as a reference to compare differences with other aeroplane types/variants within the operator's fleet.
 - b. Aeroplane variant. An aeroplane, or a group of aeroplanes, with the same characteristics but which have differences from a base aeroplane which require additional flight crew knowledge, skills, and or abilities that affect flight safety.
 - c. Credit. The acceptance of training, checking or recent experience on one type or variant as being valid for another type or variant because of sufficient similarities between the two types or variants.
 - d. Differences training. See OPS 1.950(a)(1).
 - e. Familiarisation training. See OPS 1.950(a)(2).



- f. Major change. A change, or changes, within an aeroplane type or related type, which significantly affect the flight crew interface with the aeroplane (e.g. flight characteristics, procedures, design/number of propulsion units, change in number of required flight crew).
- g. Minor change. Any change other than a major change.
- h. Operator Difference Requirements (ODRs). A formal description of differences between types or variants flown by a particular operator.

1.2 Training and checking difference levels

a. Level A

- i. Training. Level A training can be adequately addressed through self-instruction by a crew member through page revisions, bulletins or differences hand-outs. Level A introduces a different version of a system or component which the crew member has already shown the ability to use and understand. The differences result in no, or only minor, changes in procedures.
- ii. Checking. A check related to differences is not required at the time of training. However, the crew member is responsible for acquiring the knowledge and may be checked during proficiency checking.

b. Level B

- i. Training. Level B training can be adequately addressed through aided instruction such as slide/tape presentation, computer based instruction which may be interactive, video or classroom instruction. Such training is typically used for part-task systems requiring knowledge and training with, possibly, partial application of procedures (e.g. fuel or hydraulic systems etc.).
- ii. Checking. A written or oral check is required for initial and recurrent differences training.

c. Level C

- i. Training. Level C training should be accomplished by use of “hands on” FSTDs qualified according to JAR-FSTD A, Level 1 or equivalent, or higher. The differences affect skills, abilities as well as knowledge but do not require the use of “real time” devices. Such training covers both normal and non-normal procedures (for example for flight management systems).
- ii. Checking. A FSTD used for training level C or higher is used for a check of conversion and recurrent training. The check should utilise a “real time” flight environment such as the demonstration of the use of a flight management system. Manoeuvres not related to the specific task do not need to be tested.

d. Level D

- i. Training. Level D training addresses differences that affect knowledge, skills and abilities for which training will be given in a simulated flight environment involving, “real time” flight manoeuvres for which the use of an STD qualified according to JAR-FSTD A, Level 1 would not suffice, but for which motion and visual clues are not required. Such training would typically involve an FSTD as defined in JAR-FSTD A, Level 2.
- ii. Checking. A proficiency check for each type or variant should be conducted following both initial and recurrent training. However, credit may be given for manoeuvres common to each type or variant and need not be repeated. Items trained to level D differences may be checked in FSTDs qualified according to JAR-FSTD A, Level 2. Level D checks will therefore comprise at least a full proficiency check on one type or variant and a partial check at this level on the other.

e. Level E

- i. Training. Level E provides a realistic and operationally oriented flight environment achieved only by the use of Level C or D Flight Simulators or the aeroplane itself. Level E training should be conducted for types and variants which are significantly different from the base aeroplane and/or for which there are significant differences in handling qualities.



- ii. Checking. A proficiency check on each type or variant should be conducted in a level C or D Flight Simulator or the aeroplane itself. Either training or checking on each Level E type or variant should be conducted every 6 months. If training and checking are alternated, a check on one type or variant should be followed by training on the other so that a crew member receives at least one check every 6 months and at least one check on each type or variant every 12 months.

AMC OPS 1.980(b)

Methodology - Use of Operator Difference Requirement (ODR) Tables

See OPS 1.980(b)

See also AMC OPS 1.980(b)

1. General

1.1 Use of the methodology described below is acceptable to the Authority as a means of evaluating aeroplane differences and similarities to justify the operation of more than one type or variant, and when credit is sought.

2. ODR Tables

2.1 Before requiring flight crew members to operate more than one type or variant, operators should first nominate one aeroplane as the Base Aeroplane from which to show differences with the second aeroplane type or variant, the 'difference aeroplane', in terms of technology (systems), procedures, pilot handling and aeroplane management. These differences, known as Operator Difference Requirements (ODR), preferably presented in tabular format, constitute part of the justification for operating more than one type or variant and also the basis for the associated differences/familiarisation training for the flight crew.

3. The ODR Tables should be presented as follows:

3.1 Table 1 - ODR 1 – General

BASE AEROPLANE: DIFFERENCE AEROPLANE:				COMPLIANCE METHOD		
GENERAL	DIFFERENCES	FLT CHAR	PROC CHNG	Training	Checking	Recent Experience
General description of aircraft (dimensions, weight, limitations, etc.)	Identification of the relevant differences between the base aeroplane and the difference aeroplane.	Impact on flight characteristics (performance and/or handling)	Impact on procedures (Yes or No)	Assessment of the difference levels according to Table 4		

3.2

Table 2 - ODR 2 - systems

BASE AEROPLANE: DIFFERENCE AEROPLANE:				COMPLIANCE METHOD		
SYSTEM	DIFFERENCES	FLT CHAR	PROC CHNG	Training	Checking	Recent Experience
Brief description of systems and subsystems classified according to the ATA 100 index.	list of differences for each relevant subsystem between the base aeroplane and the difference aeroplane.	Impact on flight characteristics (performance and/or handling)	Impact on procedures (Yes or No)	Assessment of the difference levels according to Table 4		



3.3 Table 3 - ODR 3 - manoeuvres

BASE AEROPLANE: DIFFERENCE AEROPLANE:				COMPLIANCE METHOD		
MANOEUVRES	DIFFERENCES	FLT CHAR	PROC CHNG	Training	Checking	Recent Experience
Described according to phase of flight (gate, taxi, flight, taxi, gate)	List of relevant differences for each manoeuvre between the base aeroplane and the difference aeroplane.	Impact on flight characteristics (performance and/or handling)	Impact on procedures (Yes or No)	Assessment of the difference levels according to Table 4		

4. Compilation of ODR Tables

4.1 ODR 1 - Aeroplane general

- a. The general characteristics of the difference aeroplane should be compared with the base aeroplane with regard to:
 - i. General dimensions and aeroplane design;
 - ii. Flight deck general design;
 - iii. Cabin layout;
 - iv. Engines (number, type and position);
 - v. Limitations (flight envelope).

4.2 ODR 2 - Aeroplane systems

- a. Consideration should be given to differences in design between the difference aeroplane and the base aeroplane. This comparison should be completed using the ATA 100 index to establish system and subsystem classification and then an analysis performed for each index item with respect to main architectural, functional and/or operations elements, including controls and indications on the systems control panel.

4.3 ODR 3 - Aeroplane manoeuvres (operational differences)

- a. Operational differences encompass normal, abnormal and emergency situations and include any change in aeroplane handling and flight management. It is necessary to establish a list of operational items for consideration on which an analysis of differences can be made. The operational analysis should take the following into account:
 - i. Flight deck dimensions (e.g. size, cut-off angle and pilot eye height);
 - ii. Differences in controls (e.g. design, shape, location, function);
 - iii. Additional or altered function (flight controls) in normal or abnormal conditions;
 - iv. Procedures;
 - v. Handling qualities (including inertia) in normal and abnormal configurations;
 - vi. Performance in manoeuvres;
 - vii. Aeroplane status following failure;
 - viii. Management (e.g. ECAM, EICAS, navaid selection, automatic checklists).

4.4 Once the differences for ODR 1, ODR 2 and ODR 3 have been established, the consequences of differences evaluated in terms of Flight Characteristics (FLT CHAR) and Change of Procedures (PROC CHNG) should be entered into the appropriate columns.

4.5 Difference Levels - crew training , checking and currency

4.5.1 The final stage of the operator’s proposal to operate more than one type or variant is to establish crew training, checking and currency requirements. This may be established by applying the coded difference levels from Table 4 to the Compliance Method column of the ODR Tables.



- 5. Differences items identified in the ODR systems as impacting flight characteristics, and/or procedures, should be analysed in the corresponding ATA section of the ODR manoeuvres. Normal, abnormal and emergency situations should be addressed accordingly.
- 6. Table 4 - Difference Levels versus training

Difference Level	Method/Minimum Specification for Training Device
A: Represents knowledge requirement.	Self-Instruction through operating bulletins or differences hand-outs
B: Aided instruction is required to ensure crew understanding, emphasise issues, aid retention of information, or : aided instruction with partial application of procedures	Aided instruction e.g. computer based training (CBT), class room instruction or video tapes. Interactive CBT
C: For variants having part task differences affecting skills or abilities as well as knowledge. Training device required to ensure attainment and retention of crew skills	FSTD (FSTD A, Level 1)
D: Full task differences affecting knowledge, skills and/or abilities using FSTDs capable of performing flight manoeuvres.	FSTD (FSTD A, Level 2)
E: Full tasks differences requiring high fidelity environment to attain and maintain knowledge skills and abilities.	FSTD (FSTD A, Level C)

Note: Levels A and B require familiarisation training, levels C, D and E require differences training. For Level E, the nature and extent of the differences may be such that it is not possible to fly both types or variants with a credit in accordance with Appendix 1 to OPS 1.980, sub-paragraph (d)(7).

**AMC OPS 1.980(b)
Operation on More than One Type or Variant - Philosophy and Criteria
See OPS 1.980(b)**

- 1. Philosophy
 - 1.1 The concept of operating more than one type or variant depends upon the experience, knowledge and ability of the operator and the flight crew concerned.
 - 1.2 The first consideration is whether or not the two aeroplane types or variants are sufficiently similar to allow the safe operation of both.
 - 1.3 The second consideration is whether or not the types or variants are sufficiently similar for the training, checking and recent experience items completed on one type or variant to replace those required on the similar type or variant. If these aeroplanes are similar in these respects, then it is possible to have credit for training, checking and recent experience. Otherwise, all training, checking and recent experience requirements prescribed in Subpart N should be completed for each type or variant within the relevant period without any credit.
- 2. Differences between aeroplane types or variants
 - 2.1 The first stage in any operator’s submission for crew multi-type or variant operations is to consider the differences between the types or variants. The principal differences are in the following three areas:
 - a. Level of technology. The level of technology of each aircraft type or variant under consideration encompasses at least the following design aspects :
 - i. Flight deck layout (e.g. design philosophy chosen by a manufacturer);
 - ii. Mechanical versus electronic instrumentation;
 - iii. Presence or absence of Flight Management System (FMS);
 - iv. Conventional flight controls (hydraulic, electric or manual controls) versus fly-by-wire;
 - v. Side-stick versus conventional control column;
 - vi. Pitch trim systems;



- vii. Engine type and technology level (e.g. jet/turboprop/piston, with or without automatic protection systems).
- b. Operational differences. Consideration of operational differences involves mainly the pilot machine interface, and the compatibility of the following:
 - i. Paper checklist versus automated display of checklists or messages (e.g. ECAM, EICAS) during all procedures;
 - ii. Manual versus automatic selection of nav aids;
 - iii. Navigation equipment;
 - iv. Aircraft weight and performance.
- c. Handling characteristics. Consideration of handling characteristics includes control response, crew perspective and handling techniques in all stages of operation. This encompasses flight and ground characteristics as well as performance influences (e.g. number of engines). The capabilities of the autopilot and autothrust systems may affect handling characteristics as well as operational procedures.
- 3. Training, checking and crew management. Alternating training and proficiency checking may be permitted if the submission to operate more than one type or variant shows clearly that there are sufficient similarities in technology, operational procedures and handling characteristics.
- 4. An example of completed ODR tables for the operator’s proposal for flight crews to operate more than one type or variant may appear as follows:

Table 1 - ODR 1 - AEROPLANE GENERAL

BASE AEROPLANE: 'X' DIFFERENCE AEROPLANE: 'Y'				COMPLIANCE METHOD		
GENERAL	DIFFERENCES	FLT CHAR	PROC CHNG	Training	Checking	Recent Experience
Flight Deck	Same flight deck arrangement, 2 observers seats on 'Y'	NO	NO	A	/	/
Cabin	'Y' max certificated passenger capacity: 335, 'X': 179	NO	NO	A	/	/

Table 2 - ODR 2 – SYSTEMS

BASE AEROPLANE: 'X' DIFFERENCE AEROPLANE: 'Y'				COMPLIANCE METHOD		
SYSTEMS	DIFFERENCES	FLT CHAR	PROC CHNG	Training	Checking	Recent Experience
21 Air Conditioning	- Trim air system - packs - cabin temperature	NO NO NO	YES NO YES	B	B	B
22 Auto flight	- FMGS architecture - FMGS functions - reversion modes	NO NO NO	NO YES YES	B C D	B C D	B B D
23 Communications						



Table 3 - ODR 3 – MANOEUVRES

BASIC AEROPLANE: 'X' DIFFERENCE AEROPLANE: 'Y'				COMPLIANCE METHOD		
MANOEUVRES	DIFFERENCES	FLT CHAR	PROC CHNG	Training	Checking	Recent Experience
Taxi	- Pilot eye height, turn radius, - two-engine taxi (1&4)	YES	NO	D	D	/
		NO	NO	A	/	/
Take-off	Flight Characteristics in ground law	YES	NO	E	E	E
Rejected Take-off	Reverser actuation logic	YES	NO	D	D	D
Take-off engine failure	- V ₁ /V _r split - Pitch attitude/lateral control	YES(P)	NO	B	B	B
		YES(H)	NO	E	E	B

P = Performance, H = Handling

AMC OPS 1.985
Training Records
See OPS 1.985

A summary of training should be maintained by the operator to show a flight crew member's completion of each stage of training and checking.

**AC/AMC O****CABIN CREW****AMC OPS 1.988****Additional Crew Members Assigned to Specialist Duties****See OPS 1.988**

The additional crew members solely assigned to specialist duties to whom the requirements of Subpart O are not applicable include the following:

- i. Child minders/escorts;
- ii. Entertainers;
- iii. Ground engineers;
- iv. Interpreters;
- v. Medical personnel;
- vi. Secretaries;
- vii. Security staff; and
- viii. Cabin auditors.

AMC OPS 1.990**Number and Composition of Cabin Crew****See OPS 1.990**

1. The demonstration or analysis referred to in OPS 1.990(b)(2) should be that which is the most applicable to the type, or variant of that type, and the seating configuration used by the operator.
2. With reference to OPS 1.990(b), the Authority may require an increased number of cabin crew members in excess of the requirements of OPS 1.990 on certain types of aeroplane or operations. Factors which should be taken into account include:
 - a. The number of exits;
 - b. The type of exits and their associated slides;
 - c. The location of exits in relation to cabin crew seats and the cabin layout;
 - d. The location of cabin crew seats taking into account cabin crew duties in an emergency evacuation including:
 - i. Opening floor level exits and initiating stair or slide deployment;
 - ii. Assisting passengers to pass through exits; and
 - iii. Directing passengers away from inoperative exits, crowd control and passenger flow management;
 - e. Actions required to be performed by cabin crew in ditchings, including the deployment of slide-rafts and the launching of life-rafts.
3. When the number of cabin crew is reduced below the minimum required by OPS 1.990(b), for example in the event of incapacitation or non-availability of cabin crew, the procedures to be specified in the Operations Manual should result in consideration being given to at least the following:
 - a. Reduction of passenger numbers;
 - b. Re-seating of passengers with due regard to exits and other applicable aeroplane limitations; and
 - c. Relocation of cabin crew and any change of procedures.
4. When scheduling cabin crew for a flight, the operator should establish procedures which take account of the experience of each cabin crew member such that the required cabin crew includes some cabin crew members who have at least 3 months operating experience as a cabin crew member.



AMC OPS 1.995(b)
Minimum Requirements
See OPS 1.995(b)

1. The initial medical examination and any re-assessment of cabin crew members must be conducted by, or under the supervision of, a medical practitioner acceptable to the Authority.
2. The operator should maintain a medical record for each cabin crew member.
3. The following medical requirements are applicable for each cabin crew member:
 - a. Good health;
 - b. Free from any physical or mental illness which might lead to incapacitation or inability to perform cabin crew duties;
 - c. Normal cardiorespiratory function;
 - d. Normal central nervous system;
 - e. Adequate visual acuity 6/9 with or without glasses;
 - f. Adequate hearing; and
 - g. Normal function of ear, nose and throat.

AMC OPS 1.1000(c)
Senior Cabin Crew Training
See OPS 1.1000(c)

Training for senior cabin crew members should include:

1. Pre-flight Briefing:
 - a. Operating as a crew;
 - b. Allocation of cabin crew stations and responsibilities; and
 - c. Consideration of the particular flight including:
 - i. Aeroplane type;
 - ii. Equipment;
 - iii. Area and type of operation including EDTO; and
 - iv. Categories of passengers, including the disabled, infants and stretcher cases;
2. Co-operation within the crew:
 - a. Discipline, responsibilities and chain of command;
 - b. Importance of co-ordination and communication; and
 - c. Pilot incapacitation;
3. Review of operators' requirements and legal requirements:
 - a. Passengers safety briefing, safety cards;
 - b. Securing of galleys;
 - c. Stowage of cabin baggage;
 - d. Electronic equipment;
 - e. Procedures when fuelling with passengers on board;
 - f. Turbulence; and
 - g. Documentation;



4. Human Factors and Crew Resource Management
(Where practicable, this should include the participation of senior cabin crew members in flight simulator Line Oriented Flying Training exercises);
5. Accident and incident reporting; and
6. Flight and duty time limitations and rest requirements.

AC OPS 1.1005/1.1010/1.1015**Crew Resource Management Training****See OPS 1.1005/1.1010/1.1015 and Appendix 2 to OPS 1.1005/1.1010/1.1015**

1. Introduction
 - 1.1 Crew Resource Management (CRM) should be the effective utilisation of all available resources (e.g. crew members, aeroplane systems, and supporting facilities) to achieve safe and efficient operation.
 - 1.2 The objective of CRM should be to enhance the communication and management skills of the crew member, as well as the importance of effective co-ordination and two-way communication between all crew members.
 - 1.3 CRM training should reflect the culture of the operator, the scale and scope of the operation together with associated operating procedures and areas of operation which produce particular difficulties.
2. General Principles for CRM Training for Cabin Crew
 - 2.1 Cabin crew CRM training should focus on issues related to cabin crew duties, and therefore, should be different from flight crew CRM training. However, the co-ordination of the tasks and functions of flight crew and cabin crew should be addressed.
 - 2.2 Whenever it is practicable to do so, operators should provide combined training for flight crew and cabin crew, including feedback, as appropriate to Appendix 2 to OPS 1.1005/1.1010/1.1015 Table 1, Columns (d), (e) and (f). This is of particular importance for senior cabin crew members.
 - 2.3 Where appropriate, CRM principles should be integrated into relevant parts of cabin crew training.
 - 2.4 CRM training should include group discussions and the review of accidents and incidents (case based studies).
 - 2.5 Whenever it is practicable to do so, relevant parts of CRM training should form part of the training conducted in cabin mock-ups or aircraft.
 - 2.6 CRM training should take into account the items listed in Appendix 2 to OPS 1.1005/1.1010/1.1015 Table 1. CRM training courses should be conducted in a structured and realistic manner.
 - 2.7 The operator should be responsible for the quality of all CRM training, including any training provided by sub-contractors/third parties (in accordance with OPS 1.035 and AMC-OPS 1.035, paragraph 5.1).
 - 2.8 CRM training for cabin crew should include, an Introductory CRM Course, operator's CRM Training, and aeroplane type-specific CRM, all of which may be combined.
 - 2.9 There should be no assessment of CRM skills. Feedback from instructors or members of the group on individual performance should be given during training to the individuals concerned.
3. Introductory CRM Course
 - 3.1 The Introductory CRM Course should provide cabin crew members with a basic knowledge of Human Factors relevant to the understanding of CRM.
 - 3.2 Cabin crew members from different operators may attend the same Introductory CRM Course provided that operations are similar (see paragraph 1.3).
4. Operator's CRM Training



- 4.1 Operator's CRM training should be the application of the knowledge gained in the Introductory CRM Course to enhance communication and co-ordination skills of cabin crew members relevant to the operator's culture and type of operation.
5. Aeroplane Type-specific CRM
 - 5.1 Aeroplane Type-specific CRM should be integrated into all appropriate phases of the operator's conversion training on the specific aeroplane type.
 - 5.2 Aeroplane Type-specific CRM should be the application of the knowledge gained in previous CRM training on the specifics related to aircraft type, including, narrow/wide bodied aeroplanes, single/multi deck aeroplanes, and flight crew and cabin crew composition.
6. Annual Recurrent Training
 - 6.1 When a cabin crew member undergoes annual recurrent training, CRM training should be integrated into all appropriate phases of the recurrent training and may include stand-alone modules.
 - 6.2 When CRM elements are integrated into all appropriate phases of the recurrent training, the CRM elements should be clearly identified in the training syllabus.
 - 6.3 Annual Recurrent CRM Training should include realistic operational situations.
 - 6.4 Annual Recurrent CRM Training should include areas as identified by the operator's accident prevention and flight safety programme (see OPS 1.037).
7. CRM Training for Senior Cabin Crew
 - 7.1 CRM training for senior cabin crew members should be the application of knowledge gained in previous CRM training and operational experience relevant to the specific duties and responsibilities of a Senior Cabin Crew Member.
 - 7.2 The senior cabin crew member should demonstrate ability to manage the operation and take appropriate leadership/management decisions.
8. CRM Instructor Qualifications
 - 8.1 The operator should ensure that all personnel conducting relevant training are suitably qualified to integrate elements of CRM into all appropriate training programmes.
 - 8.2 A training and standardisation programme for CRM instructors should be established.
 - 8.3 Cabin crew CRM instructors should:
 - a. Have suitable experience of commercial air transport as a cabin crew member; and
 - b. Have received instruction on Human Factors Performance Limitations (HPL); and
 - c. Have completed an Introductory CRM Course and the Operator's CRM training; and
 - d. Have received instructions in training skills in order to conduct CRM courses; and
 - e. Be supervised by suitably qualified CRM instructors when conducting their first CRM training course.
 - 8.4 An experienced non-cabin crew CRM instructor may continue to be a cabin crew CRM instructor, provided that the provisions of paragraph 8.3 b) to e) are satisfied and that a satisfactory knowledge has been demonstrated of the nature of the operation and the relevant specific aeroplane types. In such circumstances, the operator should be satisfied that the instructor has a suitable knowledge of the cabin crew working environment.
 - 8.5 Instructors integrating elements of CRM into conversion, recurrent training, or senior cabin crew member training, should have acquired relevant knowledge of human factors and have completed appropriate CRM training.



9. Co-ordination between flight crew and cabin crew training departments
- 9.1 There should be an effective liaison between flight crew and cabin crew training departments. Provision should be made for flight and cabin crew instructors to observe and comment on each other's training. Consideration should be given to creating flight deck scenarios on video for playback to all cabin crew during recurrent training, and to providing the opportunity for cabin crew, particularly senior cabin crew, to participate in flight crew LOFT exercises.

AMC OPS 1.1012**Familiarisation****See OPS 1.1012**

1. New entrant cabin crew
 - 1.1 Each new entrant cabin crew member having no previous comparable operating experience should:
 - a. Participate in a visit to the aeroplane to be operated; and
 - b. Participate in familiarisation flights as described in paragraph 3 below.
 2. Cabin crew operating on a subsequent aeroplane type
 - 2.1 A cabin crew member assigned to operate on a subsequent aeroplane type with the same operator should either:
 - a. Participate in a familiarisation flight as described in paragraph 3 below; or
 - b. Participate in an aeroplane visit to the aeroplane to be operated.
 3. Familiarisation Flights
 - 3.1 During familiarisation flights, the cabin crew member should be additional to the minimum number of cabin crew required by OPS 1.990.
 - 3.2 Familiarisation flights should be conducted under the supervision of the senior cabin crew member.
 - 3.3 Familiarisation flights should be structured and involve the cabin crew member in the participation of safety-related pre-flight, in-flight and post-flight duties.
 - 3.4 Familiarisation flights should be operated with the cabin crew member in the operator's uniform.
 - 3.5 Familiarisation flights should form part of the training record for each cabin crew member.
 4. Aeroplane visits
 - 4.1 The purpose of aeroplane visits is to familiarise each cabin crew member with the aeroplane environment and its equipment. Accordingly, aeroplane visits should be conducted by suitably qualified persons and in accordance with a syllabus described in the Operations Manual, Part D. The aeroplane visit should provide an overview of the aeroplane's exterior, interior and systems including the following:
 - a. Interphone and public address systems;
 - b. Evacuation alarm systems;
 - c. Emergency lighting;
 - d. Smoke detection systems;
 - e. Safety/emergency equipment;
 - f. Flight deck;
 - g. Cabin crew stations;
 - h. Toilet compartments;
 - i. Galleys, galley security and water shut-off;
 - j. Cargo areas if accessible from the passenger compartment during flight;
 - k. Circuit breaker panels located in the passenger compartment;
 - l. Crew rest areas;
 - m. Exit location and its environment.



- 4.2 An aeroplane familiarisation visit may be combined with the conversion training required by OPS 1.1010(c)(3).

AC OPS (AMC) 1.1005/1.1010/1.1015/1.1020**Representative Training Devices****See OPS 1.1005/1.1010/1.1015/1.1020**

1. A representative training device may be used for the training of cabin crew as an alternative to the use of the actual aeroplane or required equipment.
2. Only those items relevant to the training and testing intended to be given, should accurately represent the aeroplane in the following particulars:
 - a. Layout of the cabin in relation to exits, galley areas and safety equipment stowage;
 - b. Type and location of passenger and cabin crew seats;
 - c. Exits in all modes of operation (particularly in relation to method of operation, their mass and balance and operating forces) including failure of power assist systems where fitted
 - d. Safety equipment of the type provided in the aeroplane (such equipment may be 'training use only' items and, for oxygen and protective breathing equipment, units charged with or without oxygen may be used).
3. When determining whether an exit can be considered to be a variant of another type, the following factors should be assessed:
 - a. Exit arming/disarming;
 - b. Direction of movement of the operating handle;
 - c. Direction of exit opening;
 - d. Power assist mechanisms;
 - e. Assist means, e.g. evacuation slides

AMC OPS 1.1015**Recurrent Training****See OPS 1.1015**

Operators should ensure that a formalised course of recurrent training is provided for cabin crew in order to ensure continued proficiency with all equipment relevant to the aeroplane types that they operate.

AMC OPS 1.1020**Refresher Training****See OPS 1.1020**

In developing the content of any refresher training programme prescribed in OPS 1.1020, operators should consider (in consultation with the Authority) whether, for aeroplanes with complex equipment or procedures, refresher training may be necessary for periods of absence that are less than the 6 months prescribed in OPS 1.1020(a).

AMC OPS 1.1020(a)**Refresher Training****See OPS 1.1020(a)****See AMC OPS 1.1020**



The operator may substitute recurrent training for refresher training if the re-instatement of the cabin crew member's flying duties commences within the period of validity of the last recurrent training and checking. If the period of validity of the last recurrent training and checking has expired, conversion training is required.

AMC OPS 1.1025**Checking****See OPS 1.1025**

1. Elements of training which require individual practical participation should be combined with practical checks.
2. The checks required by OPS 1.1025 should be accomplished by the method appropriate to the type of training including:
 - a. Practical demonstration; and/or
 - b. Computer-based assessment; and/or
 - c. In-flight checks; and/or
 - d. Oral or written tests.

AC OPS 1.1030**Operation on More than One Type or Variant****See OPS 1.1030**

1. For the purposes of OPS 1.1030(b)(1), when determining similarity of exit operation the following factors should be assessed to justify the finding of similarity:
 - a. Exit arming/disarming;
 - b. Direction of movement of the operating handle;
 - c. Direction of exit opening;
 - d. Power assist mechanisms;
 - e. Assist means, e.g. evacuation slides.

Self-help exits, for example Type III and Type IV exits, need not be included in this assessment.

2. For the purposes of OPS 1.1030(a)(2) and (b)(2), when determining similarity of location and type of portable safety equipment the following factors should be assessed to justify the finding of similarity:
 - a. All portable safety equipment is stowed in the same, or in exceptional circumstances, in substantially the same location;
 - b. All portable safety equipment requires the same method of operation;
 - c. Portable safety equipment includes:
 - i. Fire fighting equipment;
 - ii. Protective Breathing Equipment (PBE);
 - iii. Oxygen equipment;



- iv. Crew lifejackets;
 - v. Torches;
 - vi. Megaphones;
 - vii. First aid equipment;
 - viii. Survival equipment and signalling equipment;
 - ix. Other safety equipment where applicable.
3. For the purposes of sub-paragraph of OPS 1.1030(a)(2) and (b)(3), type-specific emergency procedures include, but are not limited, to the following:
- a. Land and water evacuation;
 - b. In-flight fire;
 - c. Decompression;
 - d. Pilot incapacitation.
4. When changing aeroplane type or variant during a series of flights, the cabin crew safety briefing required by AMC OPS 1.210(a), should include a representative sample of type-specific normal and emergency procedures and safety equipment applicable to the actual aeroplane type to be operated.

AMC OPS 1.1035
Training Records
See OPS 1.1035

The operator should maintain a summary of training to show a trainee's completion of every stage of training and checking.

AMC to Appendix 1 to OPS 1.1005/1.1010/1.1015/1.1020
Crowd Control
See Appendix 1 to OPS 1.1005/1.1010/1.1015/1.1020

1. Crowd control
- 1.1 Operators should provide training in the application of crowd control in various emergency situations. This training should include:
 - a. Communications between flight crew and cabin crew and use of all communications equipment, including the difficulties of co-ordination in a smoke-filled environment;
 - b. Verbal commands;
 - c. The physical contact that may be needed to encourage people out of an exit and onto a slide;
 - d. The re-direction of passengers away from unusable exits;
 - e. The marshalling of passengers away from the aeroplane;
 - f. The evacuation of disabled passengers; and
 - g. Authority and leadership.

AMC to Appendix 1 to OPS 1.1005/1.1010/1.1015/1.1020
Training Methods
See Appendix 1 to OPS 1.1005/1.1010/1.1015/1.1020

Training may include the use of mock-up facilities, video presentations, computer based training and other types of training. A reasonable balance between the different training methods should be achieved.



AMC to Appendix 1 to OPS 1.1010/1.1015
Conversion and Recurrent Training
See Appendix 1 to OPS 1.1010/1.1015

1. A review should be carried out of previous initial training given in accordance with OPS 1.1005 in order to confirm that no item has been omitted. This is especially important for cabin crew members first transferring to aeroplanes fitted with life-rafts or other similar equipment.
2. Fire and smoke training requirements

Training requirement/interval	Required activity		
First conversion to aeroplane type (e.g. new entrant)	Actual fire fighting and handling equipment		(Note 1)
Every year during recurrent training		Handling equipment	
Every 3 years during recurrent training	Actual fire fighting and handling equipment		(Note 1)
Subsequent a/c conversion	(Note 1)	(Note 1)	(Notes 2 & 3)
New fire fighting equipment		Handling equipment	

Notes:

1. *Actual fire fighting during training must include use of at least one fire extinguisher and extinguishing agent as used on the aeroplane type. An alternative extinguishing agent may be used in place of Halon.*
2. *Fire fighting equipment is required to be handled if it is different to that previously used.*
3. *Where the equipment between aeroplane types is the same, training is not required if within the validity of the 3 year check.*
4. *A comprehensive drill to cover all ditching procedures should be practised where flotation equipment is carried. This should include practice of the actual donning and inflation of a lifejacket, together with a demonstration or film of the inflation of life-rafts and/or slide-rafts and associated equipment. This practice should, on an initial conversion course, be conducted using the equipment in water, although previous certificated training with another operator or the use of similar equipment will be accepted in lieu of further wet-drill training.*



This Page Intentionally Left Blank



AC/MC/AMC P

MANUALS, LOGS & RECORDS

AMC OPS 1.1040(b)**Elements of the Operations Manual Subject to Approval****See OPS 1.1040(b)**

- 1 A number of the provisions of OPS 1 require the prior approval of the Authority. As a consequence, the related sections of the Operations Manual should be subject to special attention. In practice, the Authority approves the operations manual, which encompasses approval of the subjects below.

Ops Manual Section (App. 1 to OPS 1.1045)	Subject	OPS Reference
A 2.4	Operational Control	1.195
A 5.2(f)	Procedures for flight crew to operate on more than 1 type or variant	1.980
A 5.3(c)	Procedures for cabin crew to operate on four airplane types	1.1030(a)
A 8.1.1	Method of determination of minimum flight attitudes	1.250(b)
A 8.1.4	En-route single-engine safe forced landing area for land planes	1.542(a)
A 8.1.8	(i) Standard mass values other than those specified in Subpart J	1.620(g)
Mass & balance:	(ii) Alternative documentation and related procedures	1.625(c)
	(iii) Omission of data from documentation	App. 1, 1.625, § (a)(1)(ii)
	(iv) Special standard masses for the traffic load	App. 1, 1.605, § (b)
A 8.1.11	Tech Log	1.915(b)
A 8.4	Cat II/III Operations	1.440(a)(3), (b) & App. 1 to OPS 1.455, Note
A 8.5	EDTO Approval	1.246
A 8.6	Use of MEL	1.030(a)
A 9	Dangerous Goods	1.1155
A 8.3.2(b)	NAT HLA	1.243
A 8.3.2(c)	RNAV (PBN)	1.243
A 8.3.2(f)	RVSM	1.241
A 8.5	EDTO	1.246
B 1.1(b)	Max. approved passenger seating configuration	1.480(a)(6)
B 2(g)	Alternate method for verifying approach mass (DH < 200ft) - Performance Class A	1.510(b)
	Steep Approach Procedures and Short Landing Operations - Performance Class B	1.515(a)(3) & (a)(4) & 1.550(a)
B 6(b)	Use of on-board mass and balance systems	App. 1 to OPS 1.625, § (c)
B 9	MEL	1.030(a)
D 2.1	Cat II/III Training syllabus flight crew	1.450(a)(2)
	Recurrent training programme flight crew	1.965(a)(2)
	Advanced qualification, programme	1.978(a)
D 2.2	Initial training cabin crew	1.1005
	Recurrent training programme cabin crew	1.1015(b)
D 2.3(a)	Dangerous Goods	1.1220(a)

AMC OPS 1.1040(c)**Operations Manual - Language****See OPS 1.1040(c)**

1. OPS 1.1040(c) requires the Operations Manual to be prepared in the English language. However, it is recognised that there may be circumstances where approval for the use of another language, for part or all of the Operations Manual, is justifiable. The criteria on which such an approval may be based should include at least the following:
- a. The language(s) commonly used by the operator;
 - b. The language of related documentation used, such as the AFM;
 - c. Size of the operation;



- d. Scope of the operation i.e. European region or international route structure;
- e. Type of operation e.g. VFR/IFR; and
- f. The period of time requested for the use of another language.

AMC OPS 1.1045

Operations Manual Contents

See OPS 1.1045

1. Appendix 1 to OPS 1.1045 prescribes in detail the operational policies, instructions, procedures and other information to be contained in the Operations Manual in order that operations personnel can satisfactorily perform their duties. When compiling an Operations Manual, the operator may take advantage of the contents of other relevant documents. Material produced by the operator for Part B of the Operations Manual may be supplemented with or substituted by applicable parts of the Aeroplane Flight Manual required by OPS 1.1050 or, where such a document exists, by an Aeroplane Operating Manual produced by the manufacturer of the aeroplane. In the case of performance class B aeroplanes, it is acceptable that a "Pilot Operating Handbook" (POH) or equivalent document is used as Part B of the Operations Manual, provided that the POH covers the necessary items. For Part C of the Operations Manual, material produced by the operator may be supplemented with or substituted by applicable Route Guide material produced by a specialised professional company.
2. If the operator chooses to use material from another source in his Operations Manual he should either copy the applicable material and include it directly in the relevant part of the Operations Manual, or the Operations Manual should contain a statement to the effect that a specific manual(s) (or parts thereof) may be used instead of the specified part(s) of the Operations Manual.
3. If the operator chooses to make use of material from an alternative source (e.g. a Route Manual producer, an aeroplane manufacturer or a training organisation) as explained above, this does not absolve the operator from the responsibility of verifying the applicability and suitability of this material. (See OPS 1.1040(k)). Any material received from an external source should be given its status by a statement in the Operations Manual.

AMC OPS 1.1045(c)

Operations Manual Structure

See OPS 1.1045(c) & Appendix 1 to OPS 1.1045

1. OPS 1.1045(a) prescribes the main structure of the Operations Manual as follows:
 - Part A – General/Basic;
 - Part B – Aeroplane Operating Matters – Type related;
 - Part C – Route and Aerodrome Instructions and Information;
 - Part D – Training.
2. OPS 1.1045 (c) requires the operator to ensure that the detailed structure of the Operations Manual is acceptable to the Authority.
3. Appendix 1 to OPS 1.1045 contains a comprehensively detailed and structured list of all items to be covered in the Operations Manual. Since it is believed that a high degree of standardisation of Operations Manuals will lead to improved overall flight safety, it is strongly recommended that the structure described in this AMC should be used by operators as far as possible. A List of Contents based upon Appendix 1 to OPS 1.1045 is given below.
4. Manuals which do not comply with the recommended structure may require a longer time to be accepted/approved by the Authority.
5. To facilitate comparability and usability of Operations Manuals by new personnel, formerly employed by another operator, operators are recommended not to deviate from the numbering system used in Appendix 1 to OPS 1.1045. If there are sections which, because of the nature of the operation, do not apply, it is recommended that operators maintain the numbering system described below and insert 'Not applicable' or 'Intentionally blank' where appropriate.



AMC OPS 1.1055(a)(12)
Signature or Equivalent
See OPS 1.1055(a)(12)

1. OPS 1.1055 requires a signature or its equivalent. This AMC gives an example of how this can be arranged where normal signature by hand is impracticable and it is desirable to arrange the equivalent verification by electronic means.
2. The following conditions should be applied in order to make an electronic signature the equivalent of a conventional hand-written signature:
 - i. Electronic 'signing' should be achieved by entering a Personal Identification Number (PIN) code with appropriate security etc.;
 - ii. Entering the PIN code should generate a print-out of the individual's name and professional capacity on the relevant document(s) in such a way that it is evident, to anyone having a need for that information, who has signed the document;
 - iii. The computer system should log information to indicate when and where each PIN code has been entered;
 - iv. The use of the PIN code is, from a legal and responsibility point of view, considered to be fully equivalent to signature by hand;
 - v. The requirements for record keeping remain unchanged; and.
 - vi. All personnel concerned should be made aware of the conditions associated with electronic signature and should confirm this in writing.

AMC OPS 1.1055(b)
Journey Log
See OPS 1.1055(b)

The 'other documentation' referred to in this paragraph might include such items as the operational flight plan, the Aeroplane Technical Log, flight report, crew lists etc.

AMC to Appendix 1 to OPS 1.1045
Operations Manual Contents

1. With reference to Operations Manual Section A, paragraph 8.3.17, on cosmic radiation, limit values should be published in the Operations Manual only after the results of scientific research are available and internationally accepted.
2. With reference to Operations Manual Section B, paragraph 9 (Minimum Equipment List) and 12 (Aeroplane Systems) operators should give consideration to using the ATA number system when allocating chapters and numbers for aeroplane systems.



This Page Intentionally Left Blank

**AC/AMC Q****FLIGHT/DUTY TIME AND REST REQUIREMENTS****AC OPS 1.1140****Fatigue Risk Management System**

1.1 FRMS policy

1.1.1 The operator shall define his FRMS policy, with all elements of the FRMS clearly identified.

1.1.2 The policy shall require that the scope of FRMS operations be clearly defined in the Operations Manual.

1.1.3 The policy shall:

- a. reflect the shared responsibility of management, flight and cabin crews, and other involved personnel;
- b. clearly state the safety objectives of the FRMS;
- c. be signed by the Accountable Manager of the organisation;
- d. be communicated, with visible endorsement, to all the relevant areas and levels of the organisation;
- e. declare management commitment to effective safety reporting;
- f. declare management commitment to the provision of adequate resources for the FRMS;
- g. declare management commitment to continuous improvement of the FRMS;
- h. require that clear lines of accountability for management, flight and cabin crews, and all other involved personnel are identified; and
- i. require periodic reviews to ensure it remains relevant and appropriate.

1.2 FRMS documentation

The operator shall develop and keep current FRMS documentation that describes and records:

- a. FRMS policy and objectives;
- b. FRMS processes and procedures;
- c. accountabilities, responsibilities and authorities for these processes and procedures;
- d. mechanisms for on-going involvement of management, flight and cabin crew members, and all other involved personnel;
- e. FRMS training programmes, training requirements and attendance records;
- f. scheduled and actual flight times, duty periods and rest periods with significant deviations and reasons for deviations noted; and
- g. FRMS outputs including findings from collected data, recommendations, and actions taken.

2. Fatigue risk management processes

2.1 Identification of hazards

The operator shall develop and maintain three fundamental and documented processes for fatigue hazard identification:

2.1.1 Predictive



The predictive process shall identify fatigue hazards by examining crew scheduling and taking into account factors known to affect sleep and fatigue and their effects on performance. Methods of examination may include but are not limited to:

- a. operator or industry operational experience and data collected on similar types of operations;
- b. evidence-based scheduling practices; and
- c. bio-mathematical models.

2.1.2 Proactive

The proactive process shall identify fatigue hazards within current flight operations. Methods of examination may include but are not limited to:

- a. self-reporting of fatigue risks;
- b. crew fatigue surveys;
- c. relevant flight and cabin crew performance data;
- d. available safety databases and scientific studies; and
- e. analysis of planned versus actual time worked.

2.1.3 Reactive

The reactive process shall identify the contribution of fatigue hazards to reports and events associated with potential negative safety consequences in order to determine how the impact of fatigue could have been minimized. At a minimum, the process may be triggered by any of the following:

- a. fatigue reports;
- b. confidential reports;
- c. audit reports;
- d. incidents; and
- e. flight data analysis events.

2.2 Risk assessment

The operator shall develop and implement risk assessment procedures that determine the probability and potential severity of fatigue-related events and identify when the associated risks require mitigation.

2.2.1 The risk assessment procedures shall review identified hazards and link them to:

- a. operational processes;
- b. their probability;
- c. possible consequences; and
- d. the effectiveness of existing safety barriers and controls.

2.3 Risk mitigation

2.3.1 The operator shall develop and implement risk mitigation procedures that:

- a. select the appropriate mitigation strategies;
- b. implement the mitigation strategies; and



- c. monitor the strategies' implementation and effectiveness.

3. FRMS safety assurance processes

3.1 The operator shall develop and maintain FRMS safety assurance processes to:

- a. provide for continuous FRMS performance monitoring, analysis of trends, and measurement to validate the effectiveness of the fatigue safety risk controls. The sources of data may include, but are not limited to:
 - i. hazard reporting and investigations;
 - ii. audits and surveys; and
 - iii. reviews and fatigue studies;
- b. provide a formal process for the management of change which shall include but is not limited to:
 - i. identification of changes in the operational environment that may affect FRMS;
 - ii. identification of changes within the organisation that may affect FRMS; and
 - iii. consideration of available tools which could be used to maintain or improve FRMS performance prior to implementing changes; and
- c. provide for the continuous improvement of the FRMS. This shall include but is not limited to:
 - i. the elimination and/or modification of risk controls have had unintended consequences or that are no longer needed due to changes in the operational or organisational environment;
 - ii. routine evaluations of facilities, equipment, documentation and procedures; and
 - iii. the determination of the need to introduce new processes and procedures to mitigate emerging fatigue-related risks.

4. FRMS promotion processes

4.1 FRMS promotion processes support the on-going development of the FRMS, the continuous improvement of its overall performance, and attainment of optimum safety levels. The following shall be established and implemented by the operator as part of its FRMS:

- a. training programmes to ensure competency commensurate with the roles and responsibilities of management, flight and cabin crew, and all other involved personnel under the planned FRMS; and
- b. an effective FRMS communication plan that:
 - i. explains FRMS policies, procedures and responsibilities to all relevant stakeholders; and
 - ii. describes communication channels used to gather and disseminate FRMS-related information.



This Page Intentionally Left Blank

**AC/AMC R****TRANSPORT OF DANGEROUS GOODS BY AIR****AC OPS (AMC) 1.1150(a)(5) & (a)(6)****Terminology - Dangerous Goods Accident and Dangerous Goods Incident****See OPS 1.1150(a)(5) & (a)(6)**

1. As a dangerous goods accident (See OPS 1.1150(a)(5)) and dangerous goods incident (See OPS 1.1150(a)(6)) may also constitute an aircraft accident, serious incident or incident the criteria for the reporting both types of occurrence should be satisfied.

AC OPS 1.1160(a)**Medical Aid for a Patient****See OPS 1.1160(a)**

1. Gas cylinders, medications, other medical material (such as sterilising wipes) and wet cell or lithium batteries are the dangerous goods which are normally provided for use in flight as medical aid for a patient. However, what is carried may depend on the needs of the patient. These dangerous goods are not those which are a part of the normal equipment of the aeroplane.

AC OPS (AMC) 1.1160(b)**Dangerous Goods on an Aeroplane in Accordance with the Relevant Regulations or for Operating Reasons****See OPS 1.1160(b)**

1. Dangerous goods required to be on board an aeroplane in accordance with the relevant regulations or for operating reasons are those which are for:
 - a. The airworthiness of the aeroplane;
 - b. The safe operation of the aeroplane; or
 - c. The health of passengers or crew.
2. Such dangerous goods include but are not limited to:
 - a. Batteries;
 - b. Fire extinguishers;
 - c. First-aid kits;
 - d. Insecticides/Air fresheners;
 - e. Life saving appliances; and
 - f. Portable oxygen supplies.

AC OPS (AMC) 1.1160(c)(1)**Scope – Dangerous Goods Carried by Passengers or Crew****See OPS 1.1160(c)(1)**

1. The Technical Instructions exclude some dangerous goods from the requirements normally applicable to them when they are carried by passengers or crew members, subject to certain conditions.
2. For the convenience of operators who may not be familiar with the Technical Instructions, these requirements are repeated below.
3. The dangerous goods which each passenger or crew member can carry are:
 - a. Alcoholic beverages containing more than 24% but not exceeding 70% alcohol by volume, when in retail packagings not exceeding 5 litres and with a total not exceeding 5 litres per person;
 - b. Non-radioactive medicinal or toilet articles (including aerosols, hair sprays, perfumes, medicines containing alcohol); and, in checked baggage only, aerosols which are non-flammable, non-toxic and without subsidiary risk, when for sporting or home use. Release valves on aerosols must be protected by a cap or other suitable means to prevent inadvertent release. The net quantity of each single article should not exceed 0.5 litre or 0.5 kg and the total net quantity of all articles should not exceed 2 litres or 2 kg;



- c. Safety matches or a lighter for the person's own use and when carried on the person. 'Strike anywhere' matches, lighters containing unabsorbed liquid fuel (other than liquefied gas), lighter fuel and lighter refills are not permitted;
- d. A hydrocarbon gas-powered hair curler, providing the safety cover is securely fitted over the heating element. Gas refills are not permitted;
- e. Small cylinders of a gas of division 2.2 worn for the operation of mechanical limbs and spare cylinders of a similar size if required to ensure an adequate supply for the duration of the journey;
- f. Radioisotopic cardiac pacemakers or other devices (including those powered by lithium batteries) implanted in a person, or radio-pharmaceuticals contained within the body of a person as a result of medical treatment;
- g. A small medical or clinical thermometer containing mercury, for the person's own use, when in its protective case;
- h. Dry ice, when used to preserve perishable items, providing the quantity of dry ice does not exceed 2 kg and the package permits the release of the gas. Carriage may be in carry-on (cabin) or checked baggage, but when in checked baggage the operator's agreement is required;
- i. When carriage is allowed by the operator, small gaseous oxygen or air cylinders for medical use;
- j. When carriage is allowed by the operator, not more than two small cylinders, or other suitable gas of division 2.2, fitted into a self-inflating life-jacket and not more than two spare cylinders;
- k. When carriage is allowed by the operator, wheelchairs or other battery-powered mobility aids with non-spillable batteries, providing the equipment is carried as checked baggage. The battery should be securely attached to the equipment, be disconnected and the terminals insulated to prevent accidental short circuits;
- l. When carriage is allowed by the operator, wheelchairs or other battery-powered mobility aids with spillable batteries, providing the equipment is carried as checked baggage. When the equipment can be loaded, stowed, secured and unloaded always in an upright position, the battery should be securely attached to the equipment, be disconnected and the terminals insulated to prevent accidental short circuits. When the equipment cannot be kept upright, the battery should be removed and carried in a strong, rigid packaging, which should be leak-tight and impervious to battery fluid. The battery in the packaging should be protected against accidental short circuits, be held upright and be surrounded by absorbent material in sufficient quantity to absorb the total liquid contents. The package containing the battery should have on it 'Battery wet, with wheelchair' or 'Battery wet, with mobility aid', bear a 'Corrosives' label and be marked to indicate its correct orientation. The package should be protected from upset by securement in the cargo compartment of the aeroplane. The commander should be informed of the location of a wheelchair or mobility aid with an installed battery or of a packed battery;
- m. When carriage is allowed by the operator, cartridges for weapons, (UN0012 and UN0014 only) in Division 1.4S providing they are for that person's own use, they are securely boxed and in quantities not exceeding 5 kg gross mass and they are in checked baggage. Cartridges with explosive or incendiary projectiles are not permitted. Allowances for more than one person must not be combined into one or more packages.;
Note: Division 1.4S is a classification assigned to an explosive. It refers to cartridges which are packed or designed so that any dangerous effects from the accidental functioning of one or more cartridges in a package are confined within the package unless it has been degraded by fire, when the dangerous effects are limited to the extent that they do not hinder fire fighting or other emergency response efforts in the immediate vicinity of the package. Cartridges for sporting use are likely to be within Division 1.4S.
- n. When carriage is allowed by the operator, a mercurial barometer or mercurial thermometer in carry-on (cabin) baggage when in the possession of a representative of a government weather bureau or similar official agency. The barometer or thermometer should be packed in a strong packaging having inside a sealed inner liner or bag of strong leak-proof and puncture resistant material impervious to mercury closed in such a way as to prevent the escape of mercury from the package irrespective of its position. The commander should be informed when such a barometer or thermometer is to be carried;



- o. When carriage is allowed by the operator, heat producing articles (i.e. battery operated equipment, such as under-water torches and soldering equipment, which if accidentally activated will generate extreme heat which can cause a fire), providing the articles are in carry-on (cabin) baggage. The heat producing component or energy source should be removed to prevent accidental functioning;
 - p. With the approval of the operator(s), one avalanche rescue backpack per person equipped with a pyrotechnic trigger mechanism containing not more than 200 mg net of division 1.4S and not more than 250 mg of compressed gas in division 2.2. The backpack must be packed in such a manner that it cannot be accidentally activated. The airbags within the backpack must be fitted with pressure relief valves;
 - q. Consumer electronic devices (watches, calculating machines, cameras, cell phones, lap top computers, camcorders, etc.) containing lithium or lithium ion cells or batteries when carried by passengers or crew for personal use. Spare batteries must be individually protected so as to prevent short circuits and carried in carryon baggage only. In addition, each spare battery must not exceed the following quantities:
 - For lithium metal or lithium alloy batteries, lithium content of not more than 2 grams; or for lithium ion batteries, an aggregate equivalent lithium content of not more than 8 grams.
 - Lithium ion batteries with an aggregate equivalent lithium content of more than 8 grams but not more than 25 grams may be carried in carryon baggage if they are individually protected so as to prevent short circuits and are limited to two spare batteries per person.
4. The list in the Technical Instructions of items permitted for carriage by passengers or crew may be revised periodically and OPS may not always reflect the current list. Consequently the latest version of the Technical Instructions should also be consulted.

AC OPS (AMC) 1.1165(b)

Exemptions and Approval Procedures of the Technical Instructions

See OPS 1.1165(b)

1. The Technical Instructions provide that in certain circumstances dangerous goods, which are normally forbidden on an aeroplane, may be carried. These circumstances include cases of extreme urgency or when other forms of transport are inappropriate or when full compliance with the prescribed requirements is contrary to the public interest. In these circumstances all the States concerned may grant exemptions from the provisions of the Technical Instructions provided that every effort is made to achieve an overall level of safety which is equivalent to that provided by the Technical Instructions. Although exemptions are most likely to be granted for the carriage of dangerous goods which are not permitted in normal circumstances, they may also be granted in other circumstances, such as when the packaging to be used is not provided for by the appropriate packing method or the quantity in the packaging is greater than that permitted. The Instructions also make provision for some dangerous goods to be carried when an approval has been granted only by the State of Origin, providing specific conditions, which are laid down in the Technical Instructions, are met.
2. The States concerned are those of origin, transit, overflight and destination of the consignment and that of the operator. However, the Technical Instructions allow for the State of overflight to consider an application for exemption based solely on whether an equivalent level of safety has been achieved, if none of the other criteria for granting an exemption are relevant.
3. The Technical Instructions provide that exemptions and approvals are granted by the "appropriate national authority", which is intended to be the authority responsible for the particular aspect against which the exemption or approval is being sought. The Instructions do not specify who should seek exemptions and, depending on the legislation of the particular State, this may mean the operator, the shipper or an agent. If an exemption or approval has been granted to other than The operator, the operator should ensure a copy has been obtained before the relevant flight. the operator should ensure all relevant conditions on an exemption or approval are met.
4. The exemption or approval referred to in OPS 1.1165(b) is in addition to the approval required by OPS 1.1155.



AC OPS 1.1215(c)(1)
Information to the Commander
See OPS 1.1215(c)(1)

If the volume of information provided to the commander is such that it would be impracticable to transmit it in the event of an in-flight emergency, a summary of the information should be provided to the commander by the operator, containing at least the quantities and class or division of the dangerous goods in each cargo compartment.

AC OPS (AMC) 1.1215(e)
Information in the Event of an In-flight Emergency
See OPS 1.1215(e)

1. To assist the ground services in preparing for the landing of an aeroplane in an emergency situation, it is essential that adequate and accurate information about any dangerous goods carried on board as cargo be given to the appropriate air traffic services unit. Wherever possible this information should include the proper shipping name and/or the UN/ID number, the class/division and for Class 1 the compatibility group, any identified subsidiary risks(s), the quantity and the location on board the aeroplane.
2. When it is not possible to include all the information, those parts thought most relevant in the circumstances should be given, such as the UN/ID numbers or classes/divisions and quantity or a summary of the quantities and class/division in each cargo compartment. As an alternative, a telephone number can be given from where a copy of the written information to the commander can be obtained during the flight.
3. It is accepted that due to the nature of the in-flight emergency, the situation may never permit the commander to inform the appropriate air traffic services unit of the dangerous goods carried as cargo on board the aeroplane.

AC OPS (AMC) 1.1220
Training
See OPS 1.1220

1. Application for Approval of Training Programmes

Applications for approval of training programmes should indicate how the training will be carried out. Training intended to give general information and guidance may be by any means including hand-outs, leaflets, circulars, slide presentations, videos, etc., and may take place on-the-job or off-the-job. Training intended to give an in-depth and detailed appreciation of the whole subject or particular aspects of it should be by formal training courses, which should include a written examination, the successful passing of which will result in the issue of the proof of qualification. Applications for formal training courses should include the course objectives, the training programme syllabus/curricula and examples of the written examination to be undertaken.
2. Instructors. Instructors should have knowledge not only of training techniques but also of the transport of dangerous goods by air, in order that the subject be covered fully and questions adequately answered.
3. Aspects of training. The aspects of training specified in the Technical Instructions are applicable whether the training is for general information and guidance or to give an in-depth and detailed appreciation. The extent to which any aspect of training should be covered is dependent upon whether it is for general information or to give in-depth appreciation. Additional aspects not identified in the Technical Instructions may need to be covered, or some aspects omitted, depending on the responsibilities of the individual.
4. Levels of Training
 - a. Where it is intended to give an in-depth and a detailed appreciation of the whole subject or of the area(s) being covered, such that the person being trained gains in knowledge so as to be able to apply the detailed requirements of the Technical Instructions. This training should include establishing, by means of a written examination covering all the areas of the training programme, that a required minimum level of knowledge has been acquired; or
 - b. Where it is intended to give general information and guidance about the area(s) being covered, such that the person being trained receives an overall awareness of the subject. This training should include establishing by means of a written or oral examination covering all areas of the training programme, that a required minimum level of knowledge has been acquired.
5. How to Achieve Training



- 5.1 Training providing general information and guidance is intended to give a general appreciation of the requirements for the transport by air of dangerous goods. It may be achieved by means of hand-outs, leaflets, circulars, slide presentations, videos, etc., or a mixture of several of these means. The training does not need to be given by a formal training course and may take place 'on-the-job' or 'off-the-job'.
- 5.2 Training providing in-depth guidance and a detailed appreciation of the whole subject or particular areas of it is intended to give a level of knowledge necessary for the application of the requirements for the transport by air of dangerous goods. It should be given by a formal training course which takes place at a time when the person is not undertaking normal duties. The course may be by means of tuition or as a self-study programme or a mixture of both of these. It should cover all the areas of dangerous goods relevant to the person receiving the training, although areas not likely to be relevant may be omitted (for instance, training in the transport of radioactive materials may be excluded where they will not be carried by the operator).
6. Training in Emergency Procedures.
- a. Except for crew members whose emergency procedures training is covered in sub-paragraphs 6b or 6c (as applicable) below:
 - i. Dealing with damaged or leaking packages; and
 - ii. Other actions in the event of ground emergencies arising from dangerous goods;
 - b. For flight crew members:
 - i. Actions in the event of emergencies in flight occurring in the passenger cabin or in the cargo compartments; and
 - ii. The notification to Air Traffic Services should an in-flight emergency occur (See OPS 1.1215(e)).
 - c. For crew members other than flight crew members:
 - i. Dealing with incidents arising from dangerous goods carried by passengers; or
 - ii. Dealing with damaged or leaking packages in flight.
7. Recurrent training should cover the areas relevant to initial Dangerous Goods training unless the responsibility of the individual has changed.
8. Test to verify understanding. It is necessary to have some means of establishing that a person has gained an understanding as a result of training; this is achieved by requiring the person to undertake a test. The complexity of the test, the manner of conducting it and the questions asked should be commensurate with the duties of the person being trained; and the test should demonstrate that the training has been adequate. If the test is completed satisfactorily a certificate should be issued confirming this.

AC OPS (AMC) 1.1225**Dangerous Goods Incident and Accident Reports****See OPS 1.1225**

Use of a standard form for the reporting of dangerous goods incidents and accidents would assist the Authorities and enable them to establish quickly the essential details of an occurrence. The following form has been developed for such use and its correct and full completion means that all the details required by Appendix 1 to OPS 1.1225 would have been covered. It may be sent to the relevant Authorities by any appropriate means including fax, mail, electronic mail, etc.



This Page Intentionally Left Blank



DANGEROUS GOODS OCCURRENCE REPORT No.

Using this form will meet the reporting requirements of OPS 1.1225

1. Operator:		2. Date of occurrence:		3. Local time of occurrence:	
4. Flight date:		5. Flight no:			
6. Departure airport:		7. Destination airport:			
8. Aircraft type:		9. Aircraft registration:			
10. Location of occurrence:		11. Origin of the goods:			
12. Description of the occurrence, including details of injury, damage, etc (if necessary continue on the reverse of this form):					
13. Proper shipping name (including the technical name):				14. UN/ID no (when known):	
15. Class/division (when known):	16. Subsidiary risk(s):		17. Packing group:	18. Category (class 7 only):	
19. Type of packaging:	20. Packaging specification marking:	21. No of packages:		22. Quantity (or transport Index, if applicable):	
23. Reference no of Air Waybill:					
24. Reference no of courier pouch, baggage tag, or passenger ticket:					
25. Name and address of shipper, agent, passenger, etc:					
26. Other relevant information (including suspected cause, any action taken):					
27. Name and title of person making report:				28. Telephone no:	
29. Company:				30. Reporters ref:	
31. Address:				32. Signature:	
				33. Date:	



Description of the occurrence (continuation):

NOTES

1. Any type of dangerous goods occurrence must be reported, irrespective of whether the dangerous goods are contained in cargo, mail or baggage.
2. A dangerous goods accident is an occurrence associated with and related to the transport of dangerous goods which results in fatal or serious injury to a person or major property damage. For this purpose serious injury is an injury which is sustained by a person in an accident and which: (a) requires hospitalisation for more than 48 hours, commencing within 7 days from the date the injury was received; or (b) results in a fracture of any bones (except simple fractures of fingers, toes or nose); or (c) involves lacerations which cause severe haemorrhage, nerve, muscle or tendon damage; or (d) involves injury to any internal organ; or (e) involves second or third degree burns, or any burns affecting more than 5% of the body surface; or (f) involves verified exposure to infectious substances or injurious radiation. A dangerous goods accident may also be an aircraft accident, in which case the normal procedure for reporting of air accidents must be followed.
3. A dangerous goods incident is an occurrence, other than a dangerous goods accident, associated with and related to the transport of dangerous goods, not necessarily occurring on board an aircraft, which results in injury to a person, property damage, fire, breakage, spillage, leakage of fluid or radiation or other evidence that the integrity of the packaging has not been maintained. Any occurrence relating to the transport of dangerous goods which seriously jeopardises the aircraft or its occupants is also deemed to constitute a dangerous goods incident.
4. This form should also be used to report any occasion when undeclared or misdeclared dangerous goods are discovered in cargo, mail or unaccompanied baggage or when accompanied baggage contains dangerous goods which passengers or crew are not permitted to take on aircraft.
5. An initial report, which may be made by any means, must be despatched within 72 hours of the occurrence, to the Authority of the State (a) of the operator; and (b) in which the incident occurred, unless exceptional circumstances prevent this. This occurrence report form, duly completed, must be sent as soon as possible, even if all the information is not available.
6. Copies of all relevant documents and any photographs should be attached to this report.
7. Any further information, or any information not included in the initial report, must be sent as soon as possible to authorities identified in 5.
8. Providing it is safe to do so, all dangerous goods, packagings, documents, etc, relating to the occurrence must be retained until after the initial report has been sent to the Authorities identified in 5 and they have indicated whether or not these should continue to be retained.]

**AC S****SECURITY****AC OPS 1.1240
Training Programmes
See OPS 1.1240**

Individual crew member knowledge and competence should be based on the relevant elements described in ICAO doc 9811, "Manual of the implementation of the Security provisions of Annex 6" and ECAC DOC 30 part "Training for Cockpit and Cabin crew".

As a minimum, this programme shall include the following elements:

- (a) determination of the seriousness of any occurrence;
- (b) crew communication and coordination;
- (c) appropriate self-defence responses;
- (d) use of non-lethal protective devices assigned to crew members whose use is authorized by the State of the Operator;
- (e) understanding of behaviour of terrorists so as to facilitate the ability of crew members to cope with hijacker behaviour and passenger responses;
- (f) live situational training exercises regarding various threat conditions;
- (g) flight crew compartment procedures to protect the aeroplane; and
- (h) aeroplane search procedures and guidance on least-risk bomb locations where practicable.



This Page Intentionally Left Blank